

CONTROL CRV

Key Features:

- ▶ Components: Dual 100 mm (4 in) woofers and 19 mm (¾ in) titanium-laminate tweeter.
- ▶ Outdoor rated to IP-34 (per IEC 529).
- ▶ Built-in 70V/100V multi-tap transformer for distributed loudspeaker lines, plus 4 ohm direct capability.
- ▶ Unique, contemporary, curved design with versatile mounting configurations.
- ▶ Professional-quality input terminals.
- ▶ Superb sound quality

Overview:

The Control CRV brings high design and versatility to commercial applications such as restaurants, retail stores, lounges, theme bars, music cafes, hotels, boardrooms, boutiques, museums, leisure venues, outdoors, upscale lobbies, and other foreground and background music and paging applications that require a fashionable look with superb sound quality.

Dual 100 mm (4 in) woofers feature Polyplas™ cones for durability, large 32 mm (1½ in) voice coils wound on vented aluminum formers for high power handling, and dual neodymium magnets for high output with low harmonic distortion. The 19 mm (¾ in) tweeter features a titanium-laminate dome tweeter, a shielded neodymium magnet, and Ferrofluid® cooling for maximum power handling and reduced thermal compression. A bi-radial waveguide reduces high frequency variations in the frequency response across the listening area. The advanced high-slope crossover network (36 dB per octave high-pass to the tweeter and 18 dB per octave low-pass to the woofers) provides natural midrange sound quality along with smooth pattern coverage in the crossover region.

JBL Control CRV speakers are exceedingly versatile, with multiple installation possibilities. The JBL Control CRV speaker can be wall-mounted aimed straight out from the wall, angled down at a 45° aiming axis, mounted spanning the junction of a wall and ceiling, or spanning the junction of a wall and another wall. At a junction, the unique curved shape of the speaker couples well with both boundary surfaces, forming a dual ground plane configuration which increases the acoustic length of the speaker, providing additional spaciousness to the sound character and increased bass output. In addition, two or three Control CRV speakers can be joined together to create loudspeaker solutions for a wide variety of coverage, appearance and mounting requirements. Using the optional PMB pole-mount bracket, four speakers can be joined together and suspended by a ceiling fan pole to form a cluster module with 360° horizontal coverage.

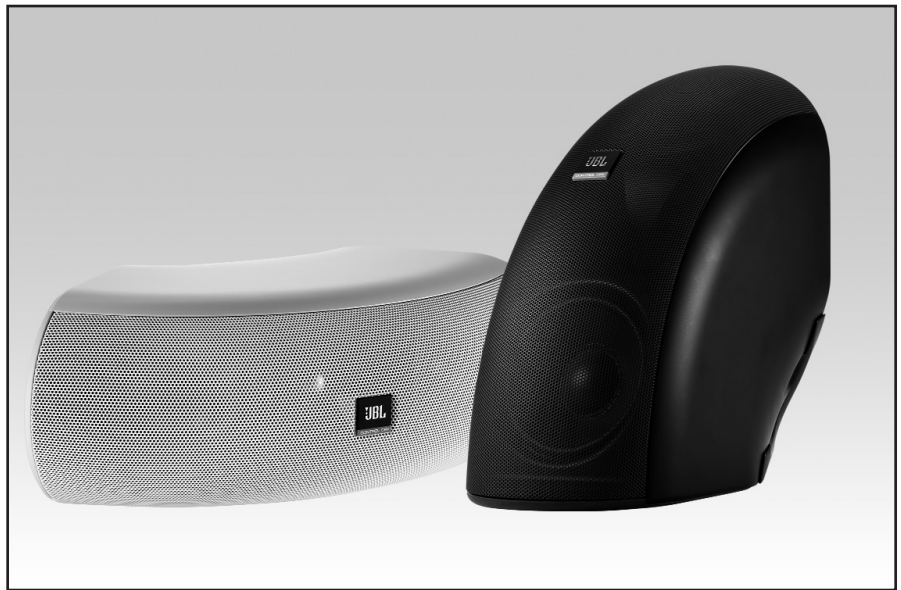

Available in either black or white (-WH), both colors are outdoor capable to IP-34 (per IEC 529), utilizing stainless steel screws, professional outdoor-rated screw-down terminals, and screened ports to prevent ingress of pests.

Specifications:

Frequency Range (-10dB):	80 Hz – 20 kHz (half-space, on-wall) 60 Hz – 20 kHz (quarter space, at two-wall junction)
Power Handling ¹ :	75 W Continuous Pink Noise, 2 hrs 60 W Continuous Pink Noise, 100 hrs 150 W Continuous Program Power 300 W Continuous Peak Power
Nominal Sensitivity ² :	89 dB
Maximum SPL @ 1m ³ :	108 dB continuous average long-term (peaks of 114 dB)
Nominal Coverage Angle:	105° horizontal x 80° vertical (2 kHz - 16 kHz, speaker in vertical orientation)
DI:	8.6 dB (2 kHz - 16 kHz)
Q	7.4 (2 kHz - 16 kHz),
Nominal Impedance	4 Ohms
Minimum Impedance:	4.0 Ohms @ 320 Hz
Crossover Frequency and Type:	2 kHz – 36dB/octave tweeter; 18dB/octave woofers
Transformer Taps:	30 W, 15 W, 7.5 W at both 70 V and 100 V (plus 3.8 W at 70 V only) Thru position is 4 ohms
Transducers:	
Low-Frequency Transducers:	Dual 4" (100 mm) PolyPlas™ shielded woofer with dual neodymium magnets and 32 mm (1.25 in) voice coil on a vented aluminum former.
High-Frequency Transducer:	3/4" (19 mm) Titanium-laminate dome tweeter, shielded neodymium magnet Ferrofluid® cooling.
Physical:	
Enclosure Material:	ABS
Ports:	Screened to protect against ingress of pests
Environmental:	IP-34 rating, per IEC529. Exceeds MilSpec 810 for humidity, salt spray, temperature & UV. Passes Mil-Std-202F for salt spray
Termination:	Screw-down terminal strip, nickel plated metal screws/washers. Accepts up to 9 mm outside 4 mm inside open lug (#6, #8, or #10 lug) plus bare wire up to 12 AWG / 2.5 mm ² .
Safety Agency Rating:	Transformer is UL registered per UL1876.
Colors:	Black or white (-WH)
Dimensions:	364 mm (14.4 in) wide, 251 mm (9.9 in) max depth including wall bracket, 262 mm (10.3 in) side depth, 127 mm (5 in) height
Net Weight (ea):	3.2 kg (7.0 lbs)
Included Accessories:	Corner/wall-mount bracket with cap, screws, and trim covers
Optional Accessories:	PMB-BK and PMB-WH (white) Pole-Mount Bracket for 4-speaker 360° hanging pendant cluster

¹Continuous Pink Noise rating is IEC-shaped pink noise with a 6 dB crest factor for 100 hours continuously. Continuous Program Power is a conservative expression of the system's ability to handle normal speech and music program material and is defined as 3 dB above the Continuous Pink Noise Rating.

²Half-space

³Calculated from sensitivity and power handling. Power compression not considered.

JBL continually engages in research related to product improvement. Changes introduced into existing products without notice are an expression of that philosophy.

► Control CRV Versatile High Design Indoor/Outdoor Loudspeaker

Frequency Response:

Free-Space (4- π), Half-Space (on-wall, 2- π), and Quarter-Space (junction of two walls, π)

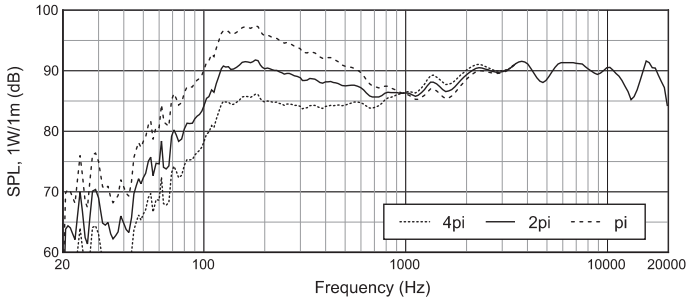

Impedance:

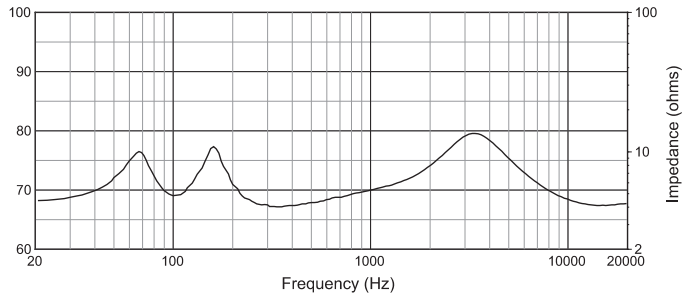

Horizontal Off-Axis Frequency Response:

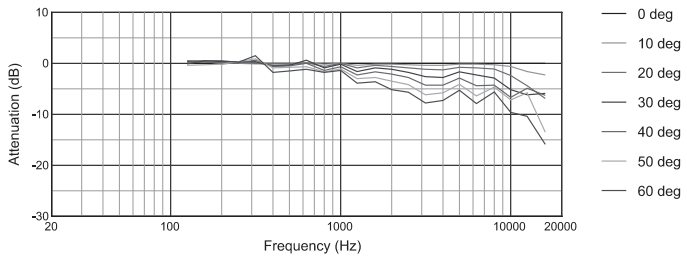

Beamwidth:

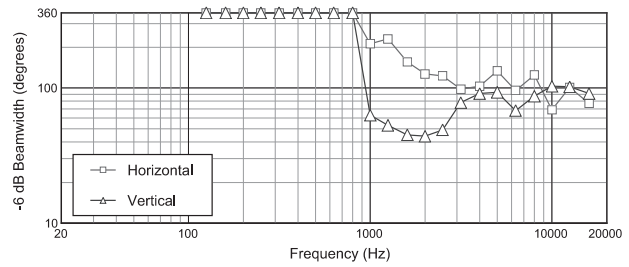

Dimensions:

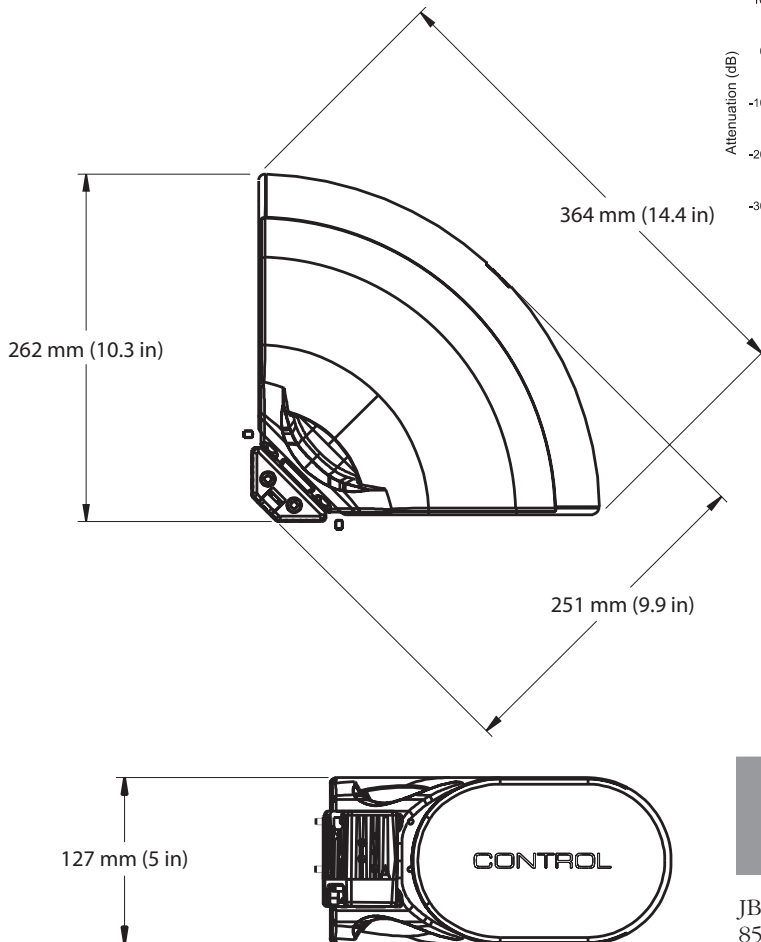

Vertical Off-Axis Frequency Response:

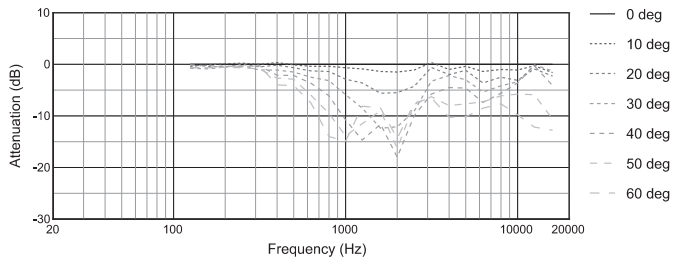

JBL Professional
8500 Balboa Boulevard, P.O. Box 2200
Northridge, California 91329 U.S.A.

Harman International
© Copyright 2009 JBL Professional
www.jblpro.com

SS CCRV
CRP
07/09