

COLORtube™ 3.0 EQ

CT3EQ CONTROLLER	Snapshot	COLORTUBE™ 3.0 EQ
⊘	Use on Dimmer	⊘
⊘	Outdoor	⊘
✓	Sound Activated	✓
✓	DMX	⊘
⊘	Master/Slave	✓
⊘	Autoswitching Power Supply	✓
✓	External Power Supply	⊘
⊘	Replaceable Fuse	⊘
⊘	User Serviceable	⊘
⊘	Duty Cycle	⊘

User Manual

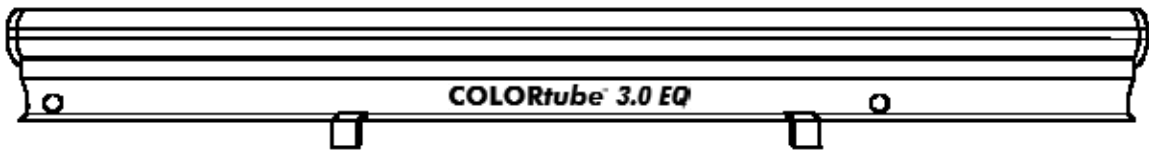

CT3EQ Controller
(Optional)

TABLE OF CONTENTS

1. BEFORE YOU BEGIN	3
WHAT IS INCLUDED.....	3
UNPACKING INSTRUCTIONS.....	3
MANUAL CONVENTIONS.....	3
ICONS.....	3
SAFETY INSTRUCTIONS.....	4
2. INTRODUCTION	5
FEATURES.....	5
FEATURES.....	5
PRODUCT OVERVIEW (CT3EQ CONTROLLER).....	6
PRODUCT OVERVIEW (COLORTUBE™ 3.0 EQ).....	7
3. SETUP	8
AC POWER.....	8
FIXTURE LINKING (COLORTUBE™ 3.0 EQ).....	8
MOUNTING.....	9
<i>Orientation</i>	9
<i>Rigging</i>	9
FIXTURE LINKING.....	10
<i>Data Cabling</i>	10
<i>DMX Data Cable</i>	10
<i>Cable Connectors</i>	10
<i>3-Pin to 5-Pin Conversion Chart</i>	11
<i>Setting up a DMX Serial Data Link</i>	11
4. OPERATING INSTRUCTIONS	12
CONFIGURING THE STARTING ADDRESS.....	12
CONTROL PANEL FUNCTIONS.....	12
MENU MAP.....	13
OPERATION	14
<i>DMX</i>	14
DMX CHANNEL VALUES.....	14
<i>Mode Channel DMX Details</i>	15
<i>Sound Active Mode Channel 2 Values</i>	15
STANDALONE AUTOMATIC AND SOUND-ACTIVE.....	16
<i>DIP Switch Settings</i>	16
SETTING THE STARTING ADDRESS.....	19
GENERAL TROUBLESHOOTING.....	19
CONTACT US.....	19
5. APPENDIX	20
DMX PRIMER.....	20
GENERAL MAINTENANCE.....	20
RETURNS PROCEDURE.....	21
CLAIMS.....	21
TECHNICAL SPECIFICATIONS.....	22
<i>COLORtube™ 3.0 EQ</i>	22
<i>CT3EQ Controller (Optional)</i>	22

1. BEFORE YOU BEGIN

What is included

- 1 x COLORtube™ 3.0 EQ
- 1 x Power Cable
- 2 x Mounting Bracket Kit
- 1 x Warranty Card
- 1 x User Manual

Unpacking Instructions

Immediately upon receiving a fixture, carefully unpack the carton, check the contents to ensure that all parts are present, and have been received in good condition. Notify the shipper immediately and retain packing material for inspection if any parts appear damaged from shipping or the carton itself shows signs of mishandling. Save the carton and all packing materials. In the event that a fixture must be returned to the factory, it is important that the fixture be returned in the original factory box and packing.



Manual Conventions

CHAUVET manuals use the following conventions to differentiate certain types of information from the regular text.

CONVENTION	MEANING
[10]	A DIP switch to be configured
<Menu>	A key to be pressed on the fixture's control panel
1~512	A range of values
50/60	A set of values of which only one can be chosen
Settings	A menu option not to be modified (for example, showing the operating mode/current status)
MENU > Settings	A sequence of menu options to be followed
ON	A value to be entered or selected

Icons

This manual uses the following icons to indicate information that requires special attention on the part of the user.

ICONS	MEANING
	This paragraph contains critical installation, configuration or operation information. Failure to comply with this information may render the fixture partially or completely inoperative, cause damage to the fixture or cause harm to the user.
	This paragraph contains important installation or configuration information. Failure to comply with this information may prevent the fixture from functioning correctly.
	This paragraph reminds you of useful, although not critical, information.

Safety Instructions



Please read these instructions carefully. It includes important information about the installation, usage and maintenance of this product.

- Please keep this User Manual for future consultation. If you sell the unit to another user, be sure that they also receive this instruction booklet.
- Always make sure that you are connecting to the proper voltage, and that the line voltage you are connecting to is not higher than that stated on the decal or rear panel of the fixture.
- This product is intended for indoor use only! To prevent risk of fire or shock, do not expose fixture to rain or moisture.
- Make sure there are no flammable materials close to the unit while operating.
- The unit must be installed in a location with adequate ventilation, at least 20 in (50 cm) from adjacent surfaces. Be sure that no ventilation slots are blocked.
- Always disconnect from power source before servicing or replacing fuse and be sure to replace with same fuse source.
- Secure fixture to fastening device using a safety chain.
- Maximum ambient temperature (Ta) is 104° F (40° C). Do not operate fixture at temperatures higher than this.
- In the event of a serious operating problem, stop using the unit immediately. Never try to repair the unit by yourself. Repairs carried out by unskilled people can lead to damage or malfunction. Please contact the nearest authorized technical assistance center.
- Never connect the device to a dimmer pack.
- Make sure the power cord is never crimped or damaged.
- Never disconnect the power cord by pulling or tugging on the cord.
- Avoid direct eye exposure to the light source while it is on.

2. INTRODUCTION

Features

- 7 user-selectable static colors plus blackout via master/slave
- 36 user-selectable automated programs with variable speeds via master/slave or optional controller
- 15 user-selectable EQ modes via master/slave
- 36 user-selectable EQ modes via optional controller
- Additional power output: max 32 units
- 100 ft max distance between each tube
- Includes 2 rail-mounted, sliding brackets
- Mount flush to ceiling/wall or to truss with clamps
- Center point and balance point marks
- For best results, use the optional CT3EQ Controller

Options

- CT3EQ Controller
- 5 ft (1.5 m) signal extension cable (LED-SIG5A)
- 15 ft (4.6 m) signal extension cable (LED-SIG15A)

CT3EQ Controller (Optional)

Features

- 6-channel DMX-COLORtube™ 3.0 EQ controller
- RGB color mixing with variable strobe rate via stand-alone or DMX
- 7 selectable preset colors (plus blackout) with variable strobe speeds
- Built-in RGB color fading with variable speeds
- Built-in automatic programs via DMX (most with variable speed and/or strobe rates)
- Built-in sound activated programs via DMX (36 different color combinations)

Additional Features

- Controls up to 225 tubes
- Addresses each tube automatically

Product Overview (CT3EQ Controller)

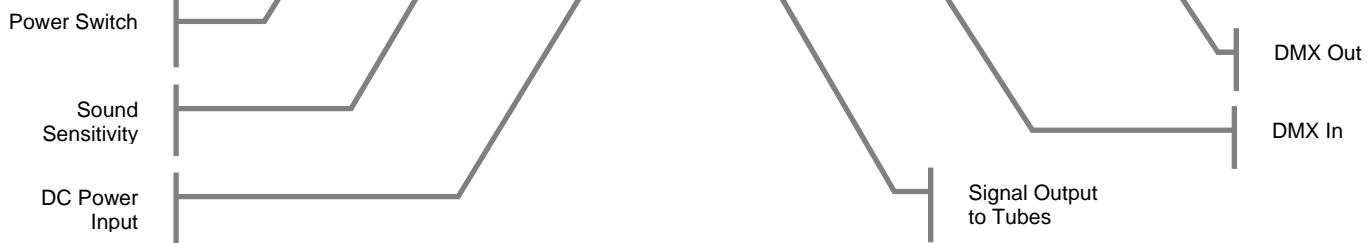
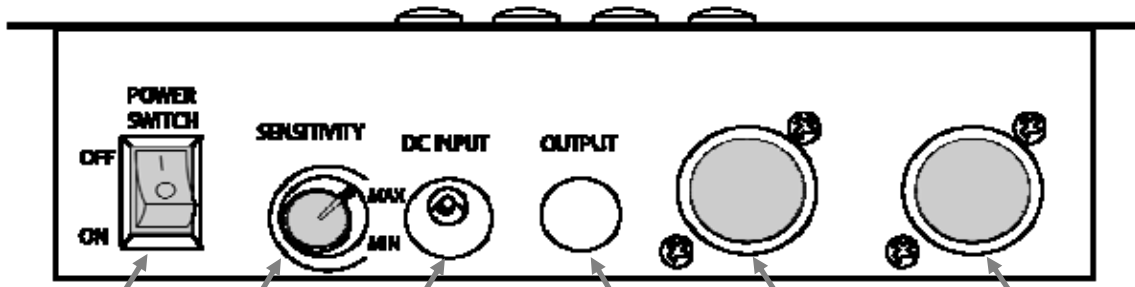
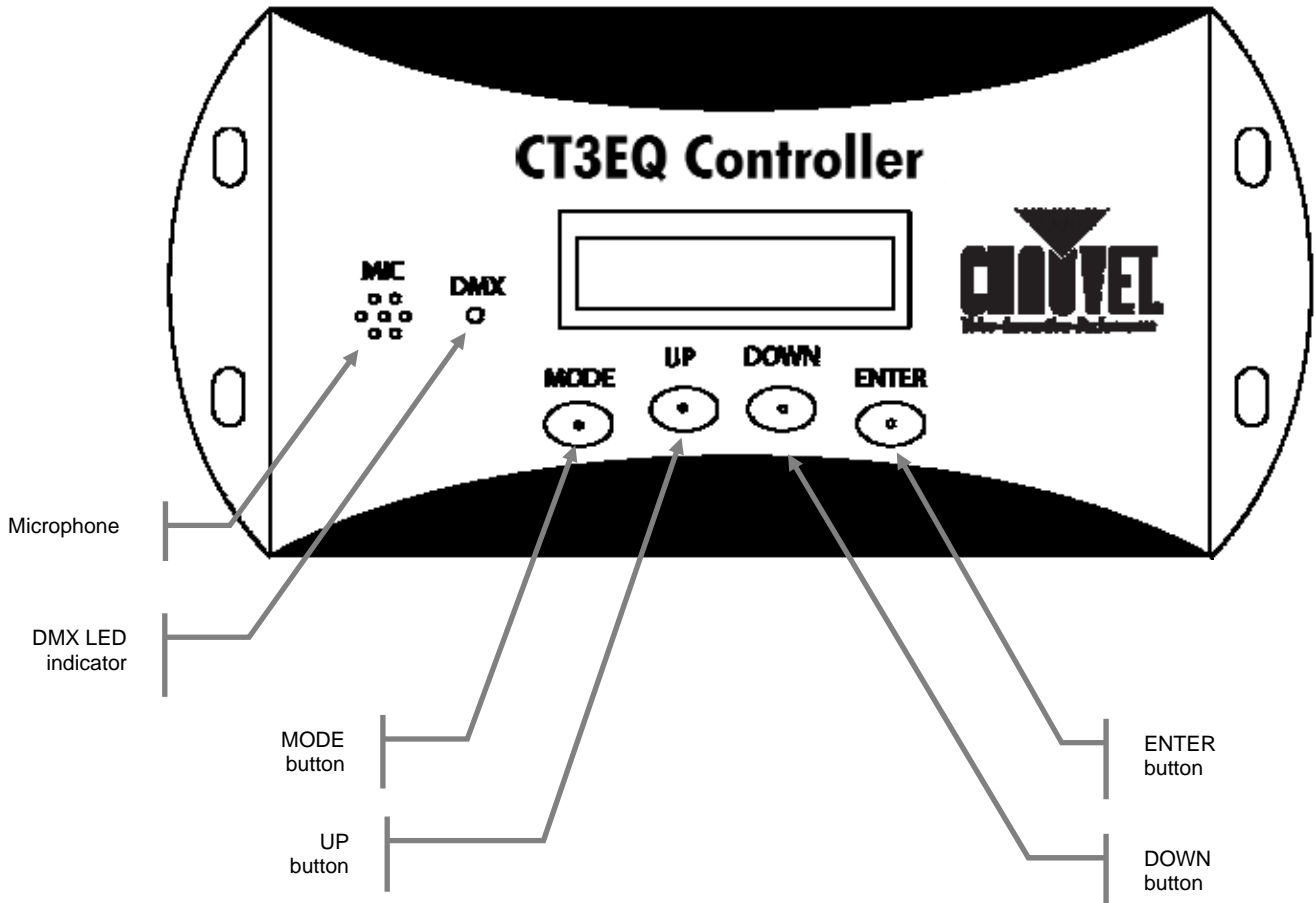

Product Overview (COLORtube™ 3.0 EQ)

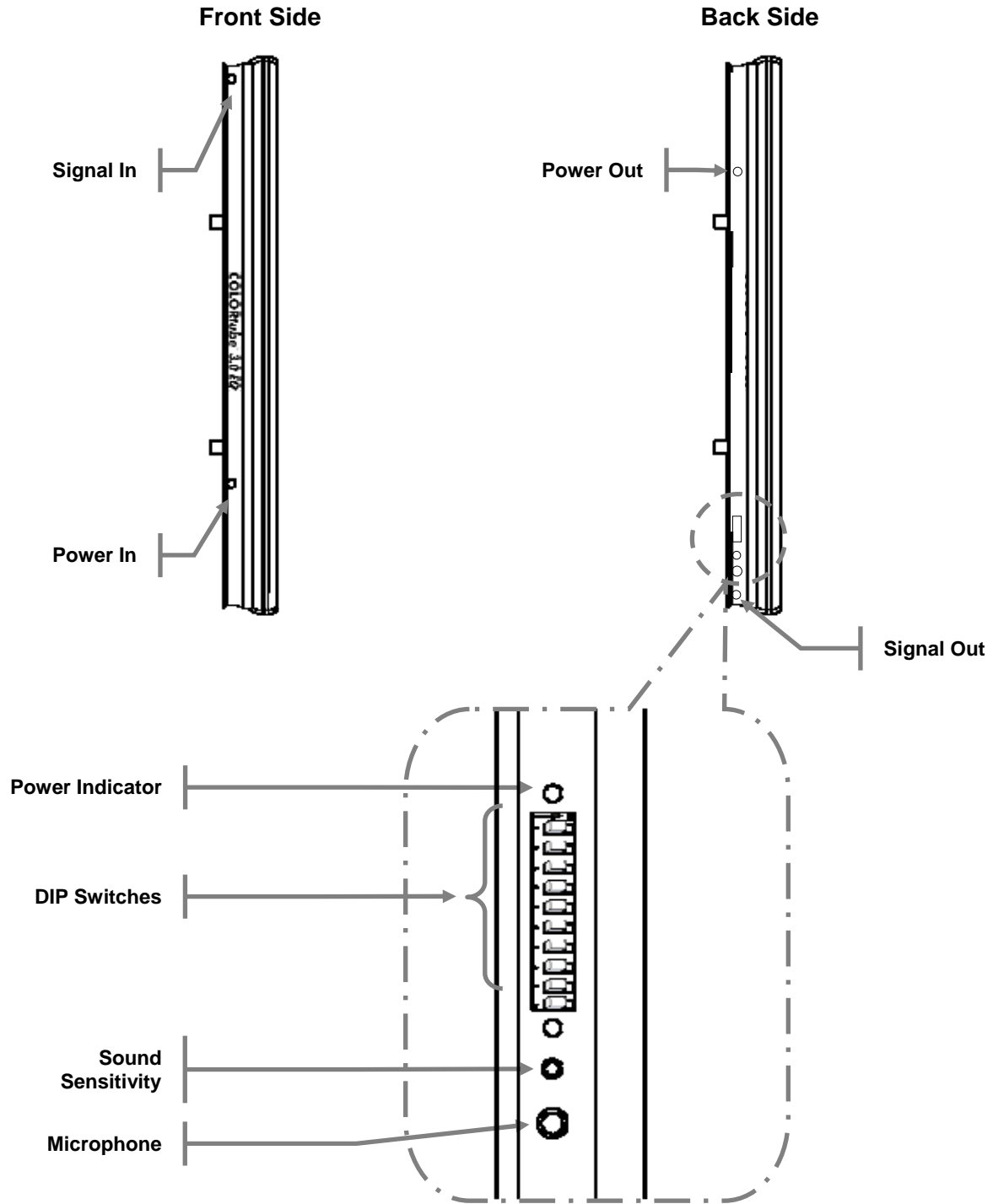

3. SETUP

AC Power

This fixture runs on 100~240 VAC, 50/60 Hz. Before powering on the unit, make sure the line voltage to which you are connecting it is within the range of accepted voltages.



Always connect the fixture to a switched circuit. Never connect the fixture to a rheostat (variable resistor) or dimmer circuit, even if the rheostat or dimmer channel is used only as a 0 to 100% switch.

To determine the power requirements for a particular fixture, see the label affixed to the back plate of the fixture or refer to the fixture's specifications chart. A fixture's listed current rating indicates its average current draw under normal conditions.



Always connect the fixture to a circuit with a suitable electrical ground.

Fixture Linking (COLORTube™ 3.0 EQ)

The COLORTube™ 3.0 EQ has both signal and power linking. Please see the diagram below for a description on how to link these fixtures.

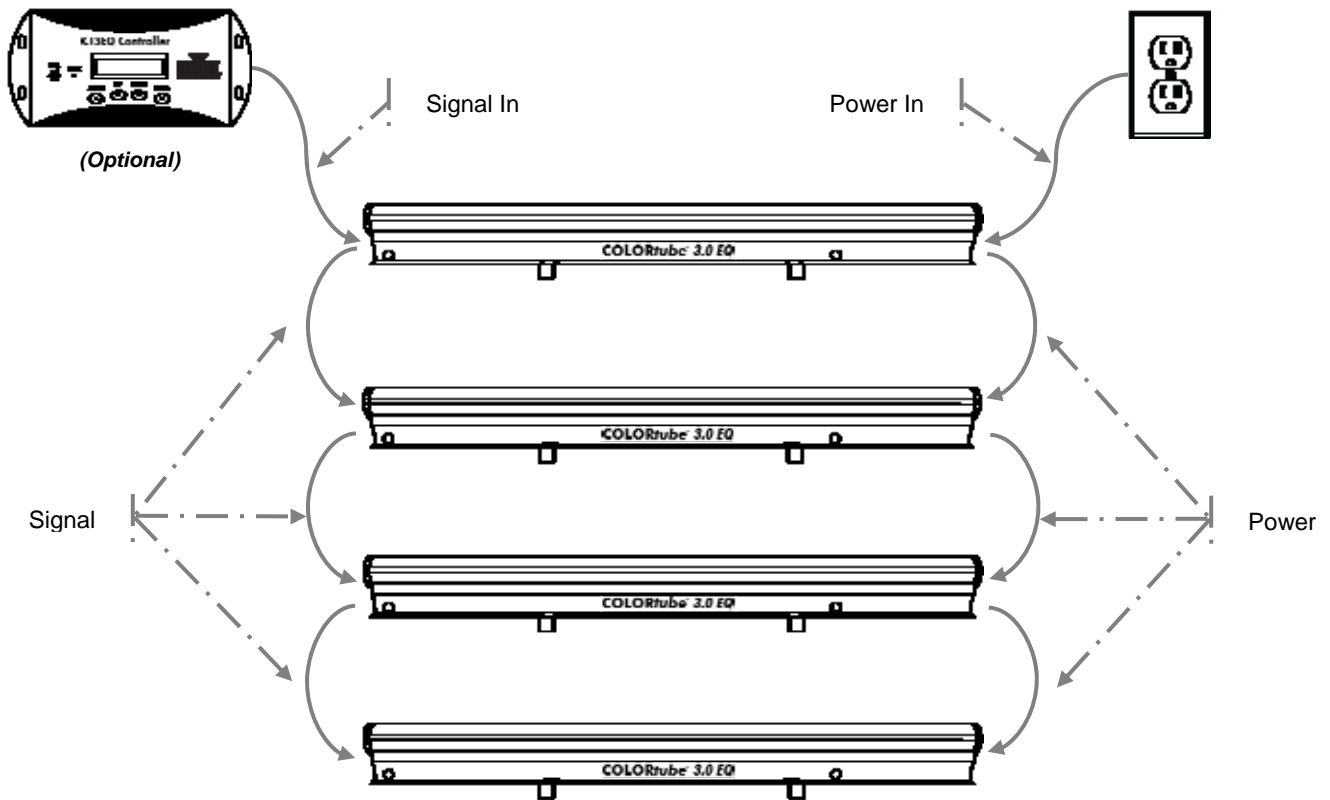

Mounting

Orientation

The COLORTube™ 3.0 EQ may be mounted in any safe position.

Rigging

Mount the fixture securely. This may be done with a screw, nut and bolt, or a hanging clamp. The hole in each bracket is 13 mm in size. When rigging consider routine maintenance and DIP switch access. Please see the following steps for installation.

1. Attach the bracket (1 or 2) to the mounting point.
2. Slide the bottom ridge of the tubes into place, as shown in the first diagram below.
3. Attach the pressure plate by using the bolt and lock washer that are included. This is done with a #5 Allen wrench.

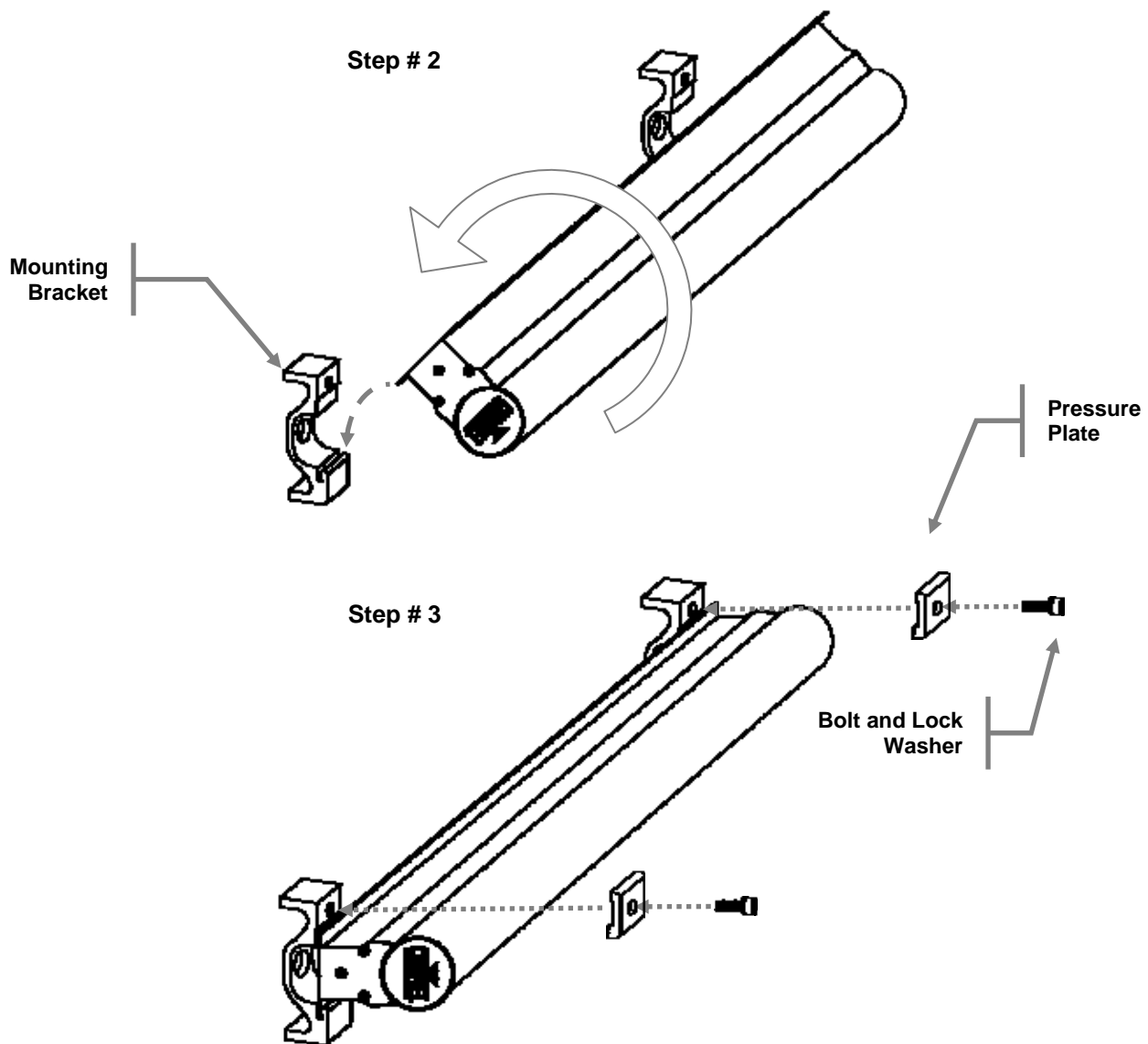

Fixture Linking

You will need a serial data link to run light shows of one or more fixtures using a DMX-512 controller or to run synchronized shows on two or more fixtures set to a master/slave operating mode. The combined number of channels required by all the fixtures on a serial data link determines the number of fixtures the data link can support.



Fixtures on a serial data link must be daisy chained in one single line. To comply with the EIA-485 standard, no more than 32 fixtures should be connected on one data link. Connecting more than 32 fixtures on one serial data link without the use of a DMX optically-isolated splitter may result in deterioration of the digital DMX signal.

Maximum recommended serial data link distance: 500 m (1640 ft)

Maximum recommended number of fixtures on a serial data link: 32

Data Cabling

To link fixtures together you must obtain data cables. You can purchase CHAUVET-certified DMX cables directly from a dealer/distributor or construct your own cable. If you choose to create your own cable please use data-grade cables that can carry a high quality signal and are less prone to electromagnetic interference.

DMX Data Cable

Use a Belden® 9841 or equivalent cable which meets the specifications for EIA RS-485 applications. Standard microphone cables cannot transmit DMX data reliably over long distances. The cable must have the following characteristics:

Type:	shielded, 2-conductor twisted pair
Maximum capacitance between conductors:	30 pF/ft
Maximum capacitance between conductor and shield:	55 pF/ft
Maximum resistance:	20 ohms/1000 ft
Nominal impedance:	100 ~ 140 ohms

Cable Connectors

Cabling must have a male XLR connector on one end and a female XLR connector on the other end.

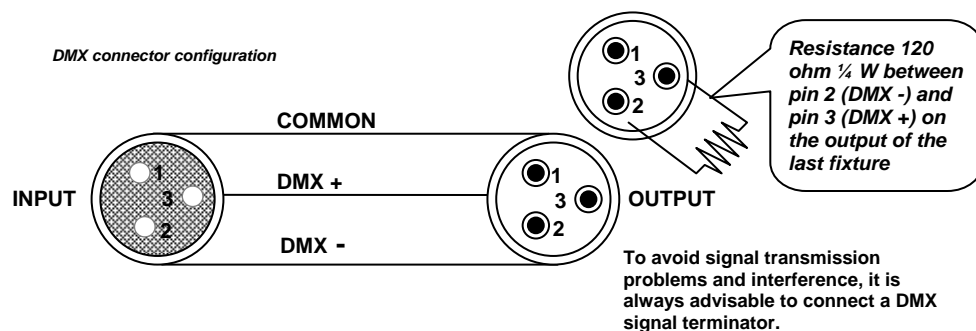

Do not allow contact between the common and the fixture's chassis ground. Grounding the common can cause a ground loop, and your fixture may perform erratically. Test cables with an ohm meter to verify correct polarity and to make sure the pins are not grounded or shorted to the shield or each other.

3-Pin to 5-Pin Conversion Chart



If you use a controller with a 5-pin DMX output connector, you will need to use a 5-pin to 3-pin adapter. CHAUVET Model No: DMX5M, or DMX5F. The chart below details a proper cable conversion:

3-PIN TO 5-PIN CONVERSION CHART		
Conductor	3-Pin Female (Output)	5-Pin Male (Input)
Ground/Shield	Pin 1	Pin 1
Data (-) signal	Pin 2	Pin 2
Data (+) signal	Pin 3	Pin 3
Not used		Pin 4
Not used		Pin 5

Setting up a DMX Serial Data Link

1. Connect the (male) 3-pin connector side of the DMX cable to the output (female) 3-pin connector of the controller.
2. Connect the end of the cable coming from the controller which will have a (female) 3-pin connector to the input connector of the next fixture consisting of a (male) 3-pin connector.
3. Then, proceed to connect from the output as stated above to the input of the following fixture and so on.

CHAUVET Certified DMX Data Cables

Order Code	Description
DMX1.5	DMX Cable 1.5 m/4.9 ft
DMX4.5	DMX Cable 4.5 m/14.8 ft
DMX10	DMX Cable 10 m/32.8 ft

Universal DMX Controller

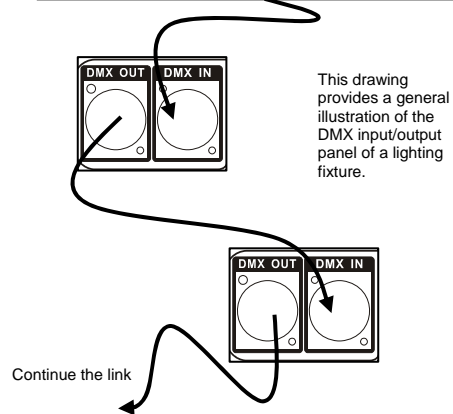
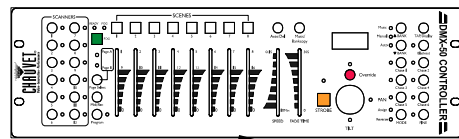

4. OPERATING INSTRUCTIONS

Configuring the Starting Address

Each fixture requires a starting address from 1~512. A fixture requiring one or more channels for control begins to read the data on the channel indicated by the starting address. For example, a fixture that uses seven DMX channels and is addressed to start on DMX channel 100, will read data from channels: 100, 101, 102, 103, 104, 105 and 106. Choose the starting addresses for each fixture so that the channels used do not overlap. In addition, you should note the starting address selected for future reference.

The COLORtube™ 3.0 EQ fixture uses six DMX channels. If this is your first time using DMX, we recommend reading the “DMX Primer” section in the “Appendix”.

Control Panel Functions

Access control panel functions using the four buttons located directly underneath the LCD Display on the included wired remote.

Button	Function
<MODE>	Used to select the current operating mode, as well as back out of the current menu option
<UP>	Used to select increasing advancement in the value
<DOWN>	Used to select decreasing advancement in the value
<ENTER>	Used to select a value and store it to memory



The Control Panel shows the current state of the unit. It is used to select the operating mode, as well as the sub-features. For a detailed layout of the control panel functions, please see the “menu map” section on the following page.

Menu Map

MAIN FUNCTION	SUB-FUNCTION	SELECTION	INSTRUCTION
STATIC COLORS	Black	Flash 000~100 (0~100%)	Select different preset colors, as well as the strobe speed
	Red		
	Green		
	Blue		
	Yellow		
	Cyan		
	Purple		
	White		
AUTO PROGRAM	1~35	Run/Flash Speed 001~100 (0~100%)	Set the speed of the program from one step to another
			Set the speed of the strobe
EQ SOUND MODE	1~36		Set the EQ sound mode
	Interval 001~100		Set the interval between color changing: slow~fast
DMX-512	-	001~512	Sets the DMX starting address
COLOR FADE	Speed	000~100 (0~100%)	Set the speed of the program from one step to another
MANUAL RGB	Red	000~100 (0~100%)	Set a custom color by combining red, green, and blue together
	Green		
	Blue		
FIND TUBES	-	-	Automatically detect the quantity of tubes connected in the series



For best results, first power on all of the tubes at the same time (simultaneously), and then power on the controller.

OPERATION

DMX

This is the operating mode which will allow for control with an external DMX controller. You must set the starting address for this mode. If this is your first time using DMX, then it is recommended that you refer to the “DMX Primer” section in the “Appendix” of this manual.

1. Press <MODE> until **DMX-512** appears on the LCD screen.
2. Press <ENTER>.
3. Using <UP> and <DOWN>, select the desired DMX address.

DMX Channel Values

1		2	3	4	5	6
Dimmer	000-005	Red 000-255	Green 000-255	Blue 000-255		
Red	006-011	No Function	No Function	No Function	No Function	000-005 No Strobe 006-255 Strobe
Green	012-017					
Blue	018-023					
Yellow	024-029					
Cyan	030-035					
Purple	036-041					
White	042-047					
Mode 1-4 See Chart Below	048-071				000-255 Run Speed	000-005 No Strobe 006-255 Strobe
Mode 5-21 See Chart Below	072-173				000-255 Run Speed	No Function
Mode 22-34 See Chart Below	174-249				000-255 Run Speed	000-005 No Strobe 006-255 Strobe
Sound See Chart Below	250-255	Sound Activity Color Change			No Function	No Function

Mode Channel DMX Details

CHANNEL 1 MODE (VALUES 048-249)

1.	3 Color Change	048-053	18.	Back N, Flow G 1	150-155
2.	7 Color Change	054-059	19.	Back N, Flow RB	156-161
3.	Rainbow 1	060-065	20.	Back N, Flow RG	162-167
4.	Rainbow 2	066-071	21.	Back N, Flow W	168-173
5.	3 Color Flow	072-077	22.	3 Color Flow Fill 2	174-179
6.	7 Color Flow	078-083	23.	7 Color Flow Fill 2	180-185
7.	3 Color Flow Roll 1	084-089	24.	3 Color Flow Roll 2	186-191
8.	7 Color Flow Roll 1	090-095	25.	7 Color Flow Roll 2	192-197
9.	3 Color Flow Fill 1	096-101	26.	Back R, Flow G 2	198-203
10.	7 Color Flow Fill 1	102-107	27.	Back G, Flow W 2	204-209
11.	3 Color Change	108-113	28.	Back B, Flow R 2	210-215
12.	7 Color Change	114-119	29.	Back W, Flow R 2	216-221
13.	Back R, Flow G 1	120-125	30.	Back N, Flow R 2	222-227
14.	Back G, Flow W 1	126-131	31.	Back N, Flow G 2	228-233
15.	Back B, Flow R 1	132-137	32.	Back N, Flow RB 2	234-239
16.	Back W, Flow R 1	138-143	33.	Back N, Flow RG 2	240-245
17.	Back N, Flow R 1	144-149	34.	Back N, Flow W 2	246-249

Sound Active Mode Channel 2 Values



CHANNEL 2 (WHEN CHANNEL 1 MODE VALUES ARE 250-255)



No Function		000-006	Back: W	Active: B	133-139
Back: R	Active: G	007-013	Back: W	Active: RG	140-146
Back: R	Active: B	014-020	Back: W	Active: GB	147-153
Back: R	Active: GB	021-027	Back: N	Active: R	154-160
Back: R	Active: RG	028-034	Back: N	Active: G	161-167
Back: R	Active: RB	035-041	Back: N	Active: B	168-174
Back: R	Active: W	042-048	Back: N	Active: RB	175-181
Back: G	Active: R	049-055	Back: N	Active: RG	182-188
Back: G	Active: B	056-062	Back: N	Active: GB	189-195
Back: G	Active: RG	063-069	Back: N	Active: W	196-202
Back: G	Active: RB	070-076	G & DOT		203-209
Back: G	Active: W	077-083	GB & DOT		210-216
Back: B	Active: R	084-090	B & DOT		217-223
Back: B	Active: G	091-097	SYNC COLORS		224-230
Back: B	Active: RG	098-104	SYNC & DOT		231-237
Back: B	Active: RB	105-111	SYNC CROSS		238-244
Back: B	Active: W	112-118	CYCLE COLORS		245-251
Back: W	Active: R	119-125	AUTO MOTION		252-255
Back: W	Active: G	126-132			

Standalone Automatic and Sound-Active

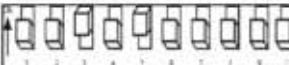
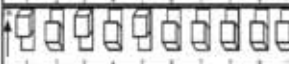
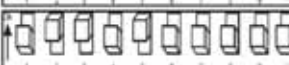
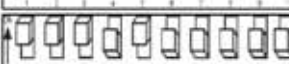
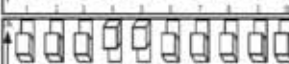
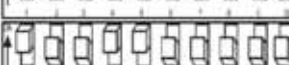
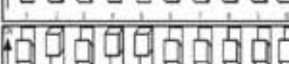
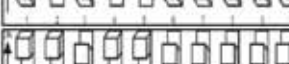
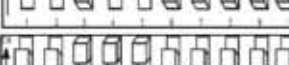
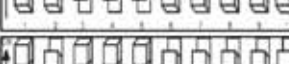
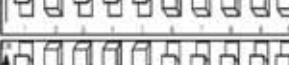
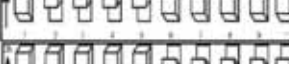
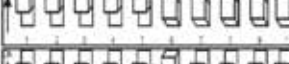
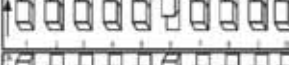
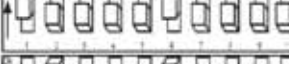
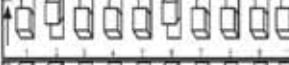
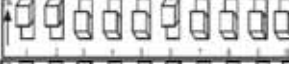
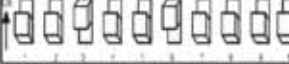

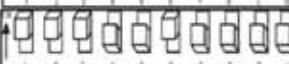
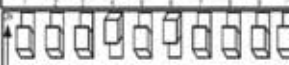

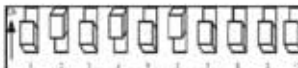
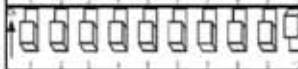
DIP Switch Settings

ACTIVE MODE	PROGRAM MODE		MODE DIPSWITCH
	ACTIVE COLOR	RUN SPEED	
0	Black	NO	
1	Red	NO	
2	Green	NO	
3	Blue	NO	
4	Yellow	NO	
5	Cyan	NO	
6	Purple	NO	
7	White	NO	
8	3 Color Change	DIP7-DIP8	
9	7 Color Change	DIP7-DIP8	
10	RainBow1	DIP7-DIP8	
11	RainBow2	DIP7-DIP8	
12	3 Color Flow	DIP7-DIP8	
13	7 Color Flow	DIP7-DIP8	
14	3 Color Flow Roll1	DIP7-DIP8	
15	7 Color Flow Roll1	DIP7-DIP8	
16	3 Color Flow Fill1	DIP7-DIP8	
17	7 Color Flow Fill1	DIP7-DIP8	
18	3 Color Change	DIP7-DIP8	
19	7 Color Change	DIP7-DIP8	

20	BCK-R Flow-G1	DIP7-DIP8	
21	BCK-G Flow-W1	DIP7-DIP8	
22	BCK-B Flow-R1	DIP7-DIP8	
23	BCK-W Flow-R1	DIP7-DIP8	
24	BCK-N Flow-R1	DIP7-DIP8	
25	BCK-N Flow-G1	DIP7-DIP8	
26	BCK-N Flow-RB1	DIP7-DIP8	
27	BCK-N Flow-RG1	DIP7-DIP8	
28	BCK-N Flow-W1	DIP7-DIP8	
29	3 Color Flow Fill2	DIP7-DIP8	
30	7 Color Flow Fill2	DIP7-DIP8	
31	3 Color Flow Roll2	DIP7-DIP8	
32	7 Color Flow Roll2	DIP7-DIP8	
33	BCK-R Flow-G2	DIP7-DIP8	
34	BCK-G Flow-W2	DIP7-DIP8	
35	BCK-B Flow-R2	DIP7-DIP8	
36	BCK-W Flow-R2	DIP7-DIP8	
37	BCK-N Flow-R2	DIP7-DIP8	
38	BCK-N Flow-G2	DIP7-DIP8	
39	BCK-N Flow-RB2	DIP7-DIP8	
40	BCK-N Flow-RG2	DIP7-DIP8	
41	BCK-N Flow- W2	DIP7-DIP8	

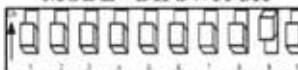
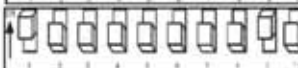
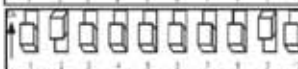
42	Color Fade	DIP7-DIP8	
43	Auto Run	DIP7-DIP8	
44	Sound Mode	NO	

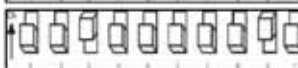
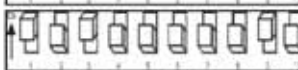
SOUND MODE EQ ACTIVE

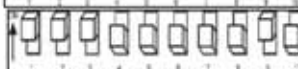
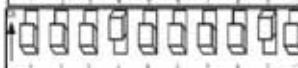
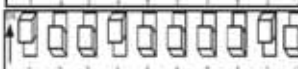
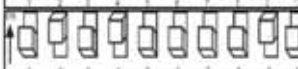
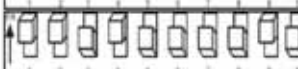
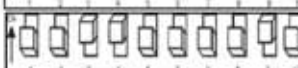
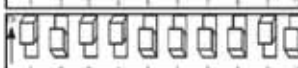
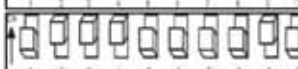
SOUND MODE	BACK COLOR	ACTIVE COLOR	MODE DIPSWITCH
0	Red	Green	
1	Green	White	
2	Blue	Red	
3	White	Red	
4	Black	Red	
5	Black	Green	
6	Black	RB	
7	Black	RG	
8		Green Dot	
9		Cyan Dot	
10		Blue Dot	
11		Sync Colors	
12		Sync Dot	
13		Sync Cross	
14		Cycle Colors	

Setting the Starting Address

This DMX mode enables the use of a universal DMX controller device. Each fixture requires a start address from 1–512. A fixture requiring one or more channels for control begins to read the data on the channel indicated by the start address. For example, a fixture that uses six DMX channels and was addressed to start on DMX channel 100, would read data from channels: 100, 101, 102, 103, 104, and 105. Choose start addresses so that the channels used do not overlap, and note the start address selected for future reference.

If this is your first time addressing a fixture using the DMX control protocol, we suggest jumping to the “Appendix” section and reading the heading “DMX Primer”. It contains very useful information that will help you understand its use.

General Troubleshooting

SYMPTOM	POSSIBLE CAUSE(S)	POSSIBLE ACTION(S)
Breaker/Fuse keeps blowing	<ul style="list-style-type: none"> Excessive circuit load Short circuit along the power wires 	<ul style="list-style-type: none"> Check total load placed on the electrical circuit. Check for a short in the electrical wiring (internal and/or external).
Device does not power up	<ul style="list-style-type: none"> No power Loose power cord 	<ul style="list-style-type: none"> Check for power on Mains. Check power cord
Fixture is not responding to DMX	<ul style="list-style-type: none"> Wrong DMX addressing Damaged DMX cables Wrong polarity settings on the controller Loose DMX cables Faulty DMX interface Faulty Main PCB 	<ul style="list-style-type: none"> Check Control Panel and unit addressing Check DMX cables Check polarity switch settings on the controller Check cable connections Replace DMX input Replace Main PCB
Loss of signal	<ul style="list-style-type: none"> Non DMX cables Bouncing signals Long cable / Low level signal Too many fixtures Interference from AC wires 	<ul style="list-style-type: none"> Use only DMX compatible cables Install terminator as suggested. Install amplifier right after fixture with strong signal. Install an optically coupled DMX splitter after unit #32. Keep DMX cables separated from power cables or black lights.



If you still have a problem after trying the above solutions, please contact CHAUVET Technical Support.

Contact Us

World Headquarters

CHAUVET®

General Information

Address: 5200 NW 108th Avenue
Sunrise, FL 33351
Voice: (954) 929-1115
Fax: (954) 929-5560
Toll free: (800) 762-1084

Technical Support

Voice: (954) 929-1115 (Press 4)
Fax: (954) 756-8015
Email: tech@chauvetlighting.com

World Wide Web

www.chauvetlighting.com

United Kingdom & Ireland

CHAUVET® Europe Ltd.

General Information

Address: Unit 1C
Brookhill Road Industrial Estate
Pinxton, Nottingham, UK
NG16 6NT
Voice: +44 (0)1773 511115
Fax: +44 (0)1773 511110

Technical Support

Email: uktech@chauvetlighting.com

World Wide Web

www.chauvetlighting.co.uk

5. APPENDIX

DMX Primer

There are 512 channels in a DMX connection. Channels may be assigned in any manner. A fixture capable of receiving DMX will require one or a number of sequential channels. The user must assign a starting address on the fixture that indicates the first channel reserved in the controller. There are many different types of DMX controllable fixtures and they all may vary in the total number of channels required. Choosing a start address should be planned in advance. Channels should never overlap. If they do, this will result in erratic operation of the fixtures whose starting address is set incorrectly. You can however, control multiple fixtures of the same type using the same starting address as long as the intended result is that of unison movement or operation. In other words, the fixtures will be slaved together and all respond exactly the same.

DMX fixtures are designed to receive data through a serial Daisy Chain. A Daisy Chain connection is where the DATA OUT of one fixture connects to the DATA IN of the next fixture. The order in which the fixtures are connected is not important and has no effect on how a controller communicates to each fixture. Use an order that provides for the easiest and most direct cabling. Connect fixtures using shielded two conductor twisted pair cable with three pin XLR male to female connectors. The shield connection is pin 1, while pin 2 is Data Negative (S-) and pin 3 is Data positive (S+). CHAUVET carries 3-pin XLR DMX compliant cables, DMX-10 (33'), DMX-4.5 (15') and DMX-1.5 (5')

General Maintenance

To maintain optimum performance and minimize wear, fixtures should be cleaned frequently. Usage and environment are contributing factors in determining frequency. As a general rule, fixtures should be cleaned at least twice a month. Dust build up reduces light output performance and can cause overheating. This can lead to reduced lamp life and increased mechanical wear. Be sure to power off fixture before conducting maintenance.

- Unplug fixture from power.
- Use a vacuum or air compressor and a soft brush to remove dust collected on external vents.
- Clean all glass when the fixture is cold with a mild solution of glass cleaner or Isopropyl Alcohol and a soft lint free cotton cloth or lens tissue.
- Apply solution to the cloth or tissue and drag dirt and grime to the outside of the lens.
- Gently polish optical surfaces until they are free of haze and lint.

The cleaning of external optical lenses and/or mirrors must be carried out periodically to optimize light output. Cleaning frequency depends on the environment in which the fixture operates. Damp, smoky or particularly dirty surroundings can cause greater accumulation of dirt on the unit's optics. Clean with soft cloth using normal glass cleaning fluid. Clean the external optics at least every 20 days. Clean the fixture at least every 30/60 days.



Always dry the parts carefully after cleaning them.



Never spin a fan using compressed air.

Returns Procedure

Returned merchandise must be sent prepaid and in the original packing; call tags will not be issued. Package must be clearly labeled with a Return Merchandize Authorization Number (RMA #). Products returned without the RMA # will be refused. Call CHAUVET and request an RMA # prior to shipping the fixture. Be prepared to provide the model number, serial number and a brief description of the cause for the return. Be sure to pack fixture properly; any shipping damage resulting from inadequate packaging is the customer's responsibility. As a suggestion, proper UPS packing or double-boxing is always a safe method to use.

CHAUVET reserves the right to use its own discretion to repair or replace product(s).



If you are given an RMA #, please include the following information on a piece of paper inside the box:

- 1) Your name
- 2) Your address
- 3) Your phone number
- 4) The RMA #
- 5) A brief description of the symptoms

Claims

Damage incurred in shipping is the responsibility of the shipper; therefore, the damage must be reported to the carrier upon receipt of merchandise. It is the customer's responsibility to notify and submit claims with the shipper in the event that a fixture is damaged due to shipping. Any other claim for items such as missing component/part, damage not related to shipping, and concealed damage, must be made within seven (7) days of receiving merchandise.

Technical Specifications

COLORtube™ 3.0 EQ

WEIGHT & DIMENSIONS

Length..... 39.2 in (995 mm)
Width 4.5 in (114 mm)
Height 2.9 in (75 mm)
Weight 4 lbs (1.8 kg)

POWER

Autoswitching Power Supply 100~240 VAC, 50/60 Hz
Power Consumption @ 120 V 36 W (0.3 A) max
Power Consumption @ 230 V 24 W (0.1 A) max

THERMAL

Maximum ambient temperature 104° F (40° C)

ORDERING INFORMATION

COLORtube™ 3.0 EQ COLORTUBE3.0EQ

WARRANTY INFORMATION

Warranty 1-year limited warranty

CT3EQ Controller (Optional)

WEIGHT & DIMENSIONS

Length..... 8.4 in (214 mm)
Width 4.6 in (116 mm)
Height 1.8 in (47 mm)
Weight 0.6 lbs (0.3 kg)

POWER

External Autoswitching Power Supply (100~240 VAC, 50/60 Hz) 12 VDC, 500 mA
Power Consumption @ 120 V 12 W (0.1 A) max
Power Consumption @ 230 V 24 W (<0.1 A) max

THERMAL

Maximum ambient temperature 104° F (40° C)

CONTROL & PROGRAMMING

Data input locking 3-pin XLR male socket
Data output locking 3-pin XLR female socket
Data pin configuration pin 1 shield, pin 2 (-), pin 3 (+)
Protocols USITT DMX512-A
DMX Channels 6

ORDERING INFORMATION

CT3EQ Controller CT3EQCONTROLLER

WARRANTY INFORMATION

Warranty 2-year limited warranty