



AC28/26 Compact 2-way Loudspeaker System with 2 - 8" LF

Key Features:

- ▶ Compact enclosure
- ▶ Dual 205 mm (8 in) LF transducers
- ▶ 120° x 60° Progressive Transition™ Field Rotatable Waveguide with a 25 mm (1 in) exit compression driver
- ▶ Dual Neutrik NL4 connectors plus screw terminals
- ▶ Multiple Attachment Points for Ultimate Flexibility

Applications:

- ▶ Performing Arts Facilities
- ▶ Houses of Worship
- ▶ Sports Facilities
- ▶ Multi Media Spaces
- ▶ Retail Spaces
- ▶ Presentation Suites
- ▶ Educational Facilities
- ▶ Portable Audio-Visual Systems

The AC28/26 is a compact full-range loudspeaker system designed to provide maximum bandwidth and SPL in a single system package and yet be visually unobtrusive. The enclosure design allows for installation very close to walls and ceilings making it an ideal choice for under balcony, column, or wall mounting. The high frequency device is a 1" exit compression driver integrated into a newly designed 120° x 60° rotatable PT™ (Progressive Transition) waveguide providing even coverage throughout the intended listening area. The combination exhibits smooth power response resulting in extremely natural voicing. The AC28/26 utilizes dual 8" Symmetrical Field Geometry (SFG™) LF Transducers each with a copper-clad aluminum edge wound 2.5" voice coil and a copper-clad pole piece that improves performance by reducing voice coil inductance and distortion. Filtered Array Technology (FAT™) is utilized to independently control the dual woofers for magnitude and phase response resulting in smoother power response and constant coverage. To further enhance the flexibility and performance of the AC28/95, JBL engineers have designed a user selectable crossover network to ensure complete accuracy of the high-frequency coverage pattern regardless of whether the loudspeaker is being used in the vertical or in the horizontal orientation when the horn is rotated.

The rugged multiply hardwood enclosure is designed to work in the vertical plane as well as in the horizontal plane. Mounting points are provided for an optional U-bracket and for an OmniMount® type bracket. The AC28/26 is also equipped with attachment points located on the bottom of the enclosure for a stand mount accessory.

The rugged plywood enclosure features JBL's textured DuraFlex™ finish and is equipped with a heavy duty powder coated steel, foam-backed grille.



Specifications:

| | |
|--|--|
| System: | |
| Frequency Range (-10 dB): | 53 Hz - 20 kHz |
| Frequency Response (+/-3 dB): | 65 Hz - 20 kHz |
| Horizontal Coverage: | 120° |
| Vertical Coverage: | 60° |
| Directivity Factor (Q): | 8.1 (avg. 500 Hz - 16 kHz) |
| Directivity Index (DI): | 6.9 dB (avg. 500 Hz - 16 kHz) |
| System Sensitivity ¹ : | 94 dB SPL/1W/1m |
| Rated Maximum SPL (1m) ² : | 120 dB |
| System Nominal Impedance: | 8 Ohms |
| Long-Term System Power Rating ³ : (Continuous/Program/Peak): | 375 W / 750 W / 1500 W |
| AES Standard Power Rating ⁴ : | 700 W |
| Crossover: | 2.1 kHz |
| Transducers: | |
| Low Frequency Driver: | 2 x JBL 228J, 205 mm (8 in) SFG™ driver with 64 mm (2.5 in) edge wound voice coil |
| High Frequency Driver: | 1 x 2408H-1 25 mm (1 in) exit compression driver, 38 mm (1.5 in) voice coil |
| High-Frequency Waveguide: | PT-D126HF-1 (field rotatable) |
| Physical: | |
| Enclosure: | 12 mm and 15 mm exterior grade multi-ply hardwood plywood |
| Suspension Attachment: | 6 x M8 points; 1 top, 3 bottom, 2 rear. 4 x M8 rear for OmniMount® 60.0. |
| Finish: | Black DuraFlex™ finish. White (-WH) available upon request. |
| Optional Weather Resistant Versions ⁵ : | WRC & WRX available upon request |
| Grille: | Powder coated 16 gauge perforated steel, acoustically transparent foam backing (grille cloth backing on white units) |
| Input Connectors: | Neutrik Speakon® NL4 (2 wired in parallel), plus CE-compliant covered barrier strip terminals. Barrier terminals accept up to 5.2 sq mm (10 AGW) wire or max width 9 mm (.375 in) spade lugs. NL4's +1/-1 in parallel with barrier strip (+2/-2 loop through). |
| Environmental Specifications: | Mil-Std 810; IPx3 per IEC529. For higher environmental ratings, use WRC or WRX. |
| Dimensions (H x W x D): | 679.5 x 238.0 254.0 mm (26.75 x 9.37 x 10 in) |
| Weight: | 18.6 kg (40.9 lb) |
| Optional Accessories: | MTU-28 U-Bracket 365469-001, M8 x 38mm Tee Knob Thumbscrew Kit for use with BMB-200k or K&M 195/8 stand mount accessory. |

¹On axis SPL measured in far field and referenced to 1 meter by inverse square law. Average from 300 Hz to 16 kHz.

²Calculated based on system sensitivity and continuous power handling.

³IEC shaped pink noise, 6 dB crest factor, 100 hour duration.

⁴AES standard 2 hour duration, with IEC system noise spectrum.

⁵WRC for outdoor placement where the loudspeaker will be sheltered from direct exposure to the elements. WRX for direct exposure or extreme environments, such as tropical or beach, or in areas with salt air, extreme high humidity or rapid changes in temperatures. See WRC/WRX configuration sheet for details.

▶ AC28/26 Compact 2-way Loudspeaker System with 2 - 8" LF

Beamwidth

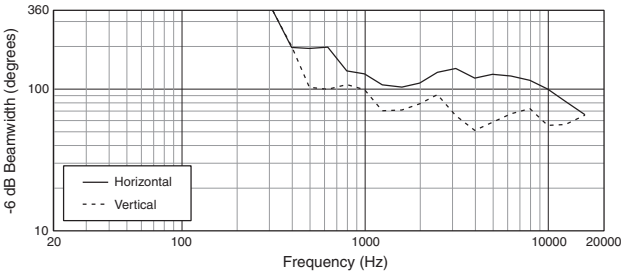

Vertical Orientation

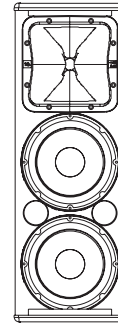

Directivity Index, Q

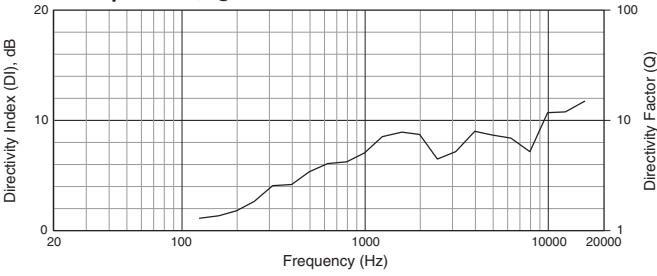

Horizontal Off-Axis Frequency Response

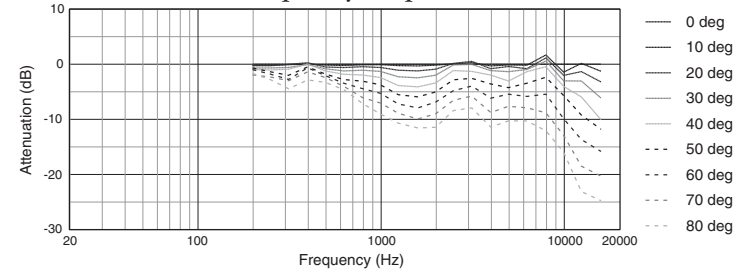

Frequency Response, 1W/1m

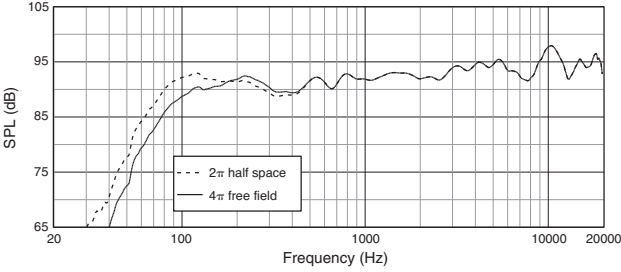

Vertical Up Off-Axis Frequency Response

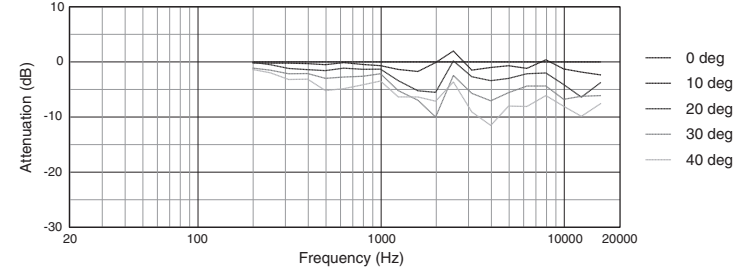

Impedance

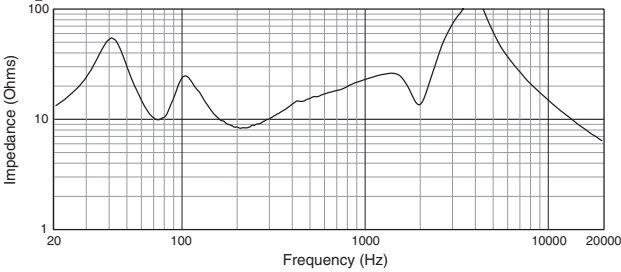

Vertical Down Off-Axis Frequency Response

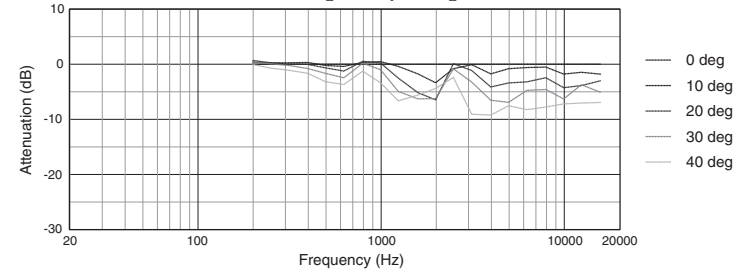

Measurements obtained in full passive crossover mode with no signal processing. Graphs are from unaltered measured data.

Beamwidth

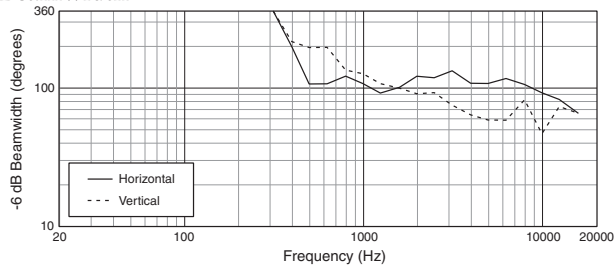

Horizontal Orientation

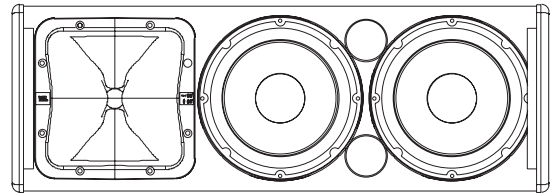

Directivity Index, Q

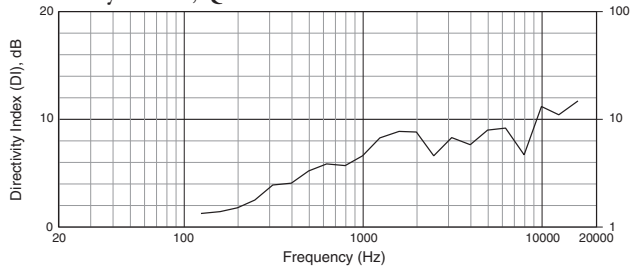

Horizontal Left Off-Axis Frequency Response

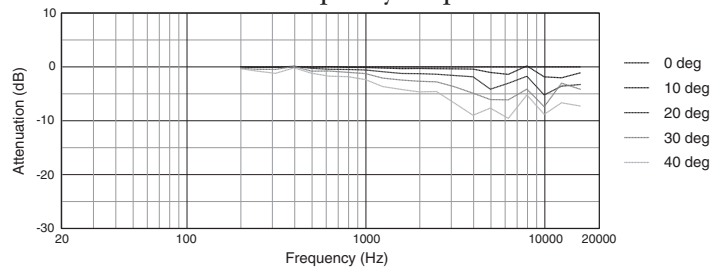

Frequency Response, 1W/1m

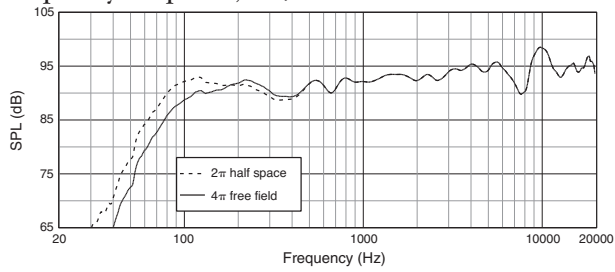

Horizontal Right Off-Axis Frequency Response

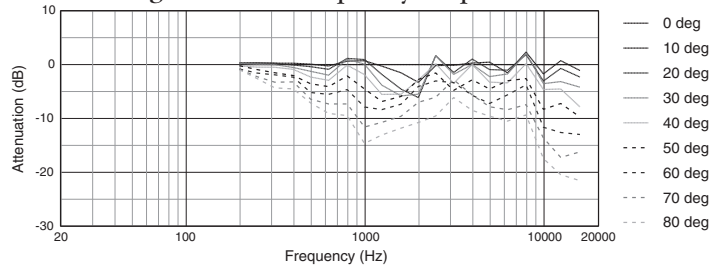

Horizontal Impedance

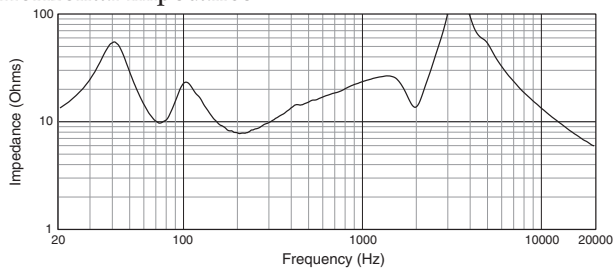

Vertical Off-Axis Frequency Response

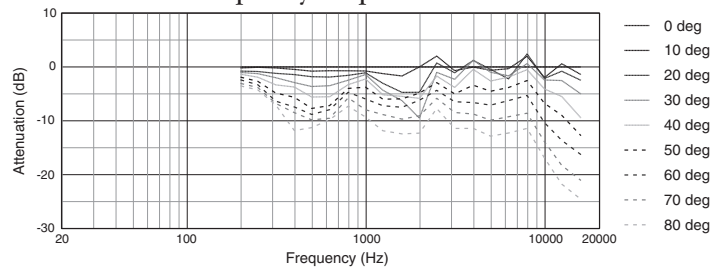

Measurements obtained in full passive crossover mode with no signal processing. Graphs are from unaltered measured data.

▶ AC28/26 Compact 2-way Loudspeaker System with 2 - 8" LF

Dimensions

Dimensions in "in" (mm)

For more detailed dimensional information, refer to Application Data Sheet

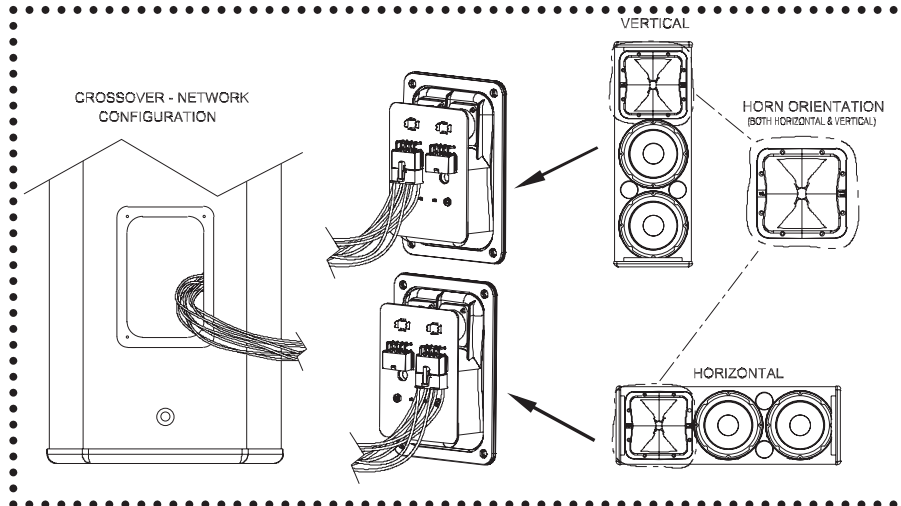
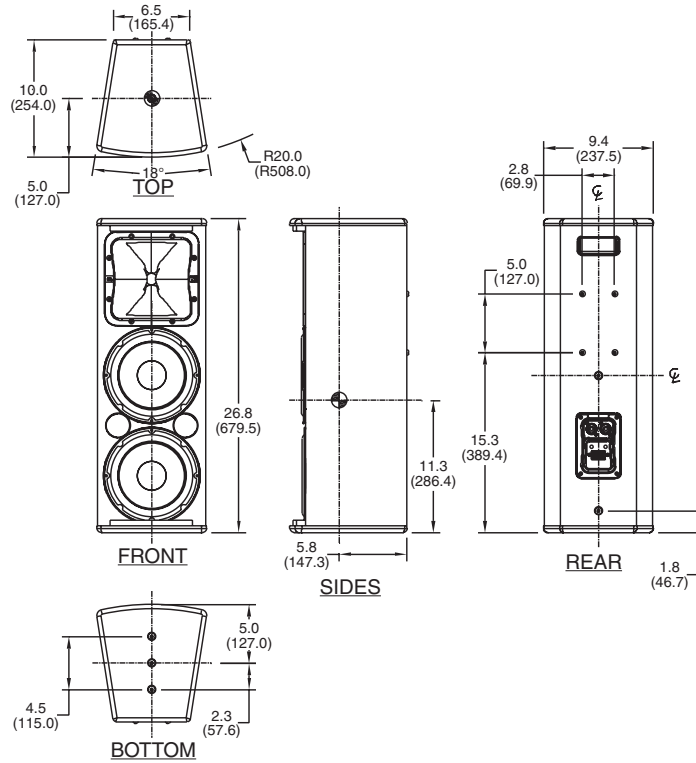

Attachment Points For Third Party Accessories:

Bottom: Ultimate Support™ BMB-200K; Konig & Meyer 195/8

Rear: OmniMount 60.0; Konig & Meyer 24480; Allen Products MM022



JBL Professional
8500 Balboa Boulevard, P.O. Box 2200
Northridge, California 91329 U.S.A.

A Harman International Company
© Copyright 2008 JBL Professional

SS AC28/26
CRP 5M
05/08