

8588062100
(428387)



Owner's Manual

Digital Multitracker

MR-8HD



Fostex[®]

	CAUTION RISK OF ELECTRIC SHOCK DO NOT OPEN	
<p>CAUTION: TO REDUCE THE RISK OF ELECTRIC SHOCK, DO NOT REMOVE COVER (OR BACK). NO USER - SERVICEABLE PARTS INSIDE. REFER SERVICING TO QUALIFIED SERVICE PERSONNEL.</p>		

"WARNING"

"TO REDUCE THE RISK OF FIRE OR ELECTRIC SHOCK, DO NOT EXPOSE THIS APPLIANCE TO RAIN OR MOISTURE."

SAFETY INSTRUCTIONS

1. Read Instructions - All the safety and operating instructions should be read before the appliance is operated.
2. Retain Instructions - The safety and operating instructions should be retained for future reference.
3. Heed Warnings - All warnings on the appliance and in the operating instructions should be adhered to.
4. Follow Instructions - All operating and use instructions should be followed.
5. Water and Moisture - The appliance should not be used near water - for example, near a bathtub, washbowl, kitchen sink, laundry tub, in a wet basement, or near a swimming pool, and the like.
6. Carts and Stands - The appliance should be used only with a cart or stand that is recommended by the manufacturer.



An appliance and cart combination should be moved with care. Quick stops, excessive force, and uneven surfaces may cause the appliance and cart combination to overturn.

7. Wall or Ceiling Mounting - The appliance should be mounted to a wall or ceiling only as recommended by the manufacturer.
8. Ventilation - The appliance should be situated so that its location or position does not interfere with its proper ventilation. For example, the appliance should not be situated on a bed, sofa, rug, or similar surface that may block the ventilation openings; or, placed in a built-in installation, such as a bookcase or cabinet that may impede the flow of air through the ventilation openings.
9. Heat - The appliance should be situated away from heat sources such as radiators, heat registers, stoves, or other appliances (including amplifiers) that produce heat.
10. Power Sources - The appliance should be connected to a power supply only of the type described in the operating instructions or as marked on the appliance.

CAUTION:

TO PREVENT ELECTRIC SHOCK, MATCH WIDE BLADE OF PLUG TO WIDE SLOT, FULLY INSERT.

ATTENTION:

POUR ÉVITER LES CHOCS ÉLECTRIQUES, INTRODUIRE LA LAME LA PLUS LARGE DE LA FICHE DANS LA BORNE CORRESPONDANTE DE LA PRISE ET POUSSER JUSQU' AU FOND.



The lightning flash with arrowhead symbol, within an equilateral triangle, is intended to alert the user to the presence of uninsulated "dangerous voltage" within the product's enclosure that may be of sufficient magnitude to constitute a risk of electric shock to persons.



The exclamation point within an equilateral triangle is intended to alert the user to the presence of important operating and maintenance (servicing) instructions in the literature accompanying the appliance.

11. Grounding or Polarization - The precautions that should be taken so that the grounding or polarization means of an appliance is not defeated.
12. Power Cord Protection - Power supply cords should be routed so that they are not likely to be walked on or pinched by items placed upon or against them, paying particular attention to cords at plugs, convenience receptacles, and the point where they exit from the appliance.
13. Cleaning - The appliance should be cleaned only as recommended by the manufacturer.
14. Nonuse Periods - The power cord of the appliance should be unplugged from the outlet when left unused for a long period of time.
15. Object and Liquid Entry - Care should be taken so that objects do not fall and liquids are not spilled into the enclosure through openings.
16. Damage Requiring Service - The appliance should be serviced by qualified service personnel when:
 - A. The power supply cord or the plug has been damaged; or
 - B. Objects have fallen, or liquid has been spilled into the appliance; or
 - C. The appliance has been exposed to rain; or
 - D. The appliance does not appear to operate normally or exhibits a marked change in performance; or
 - E. The appliance has been dropped, or the enclosure damaged.
17. Servicing - The user should not attempt to service the appliance beyond that described in the operating instructions. All other servicing should be referred to qualified service personnel.
18. The appliance should be situated away from drops of water or spray of water.
19. Objects containing liquid such as vase must not be put on the appliance.
20. The appliance is not completely isolated from the power supply even if the power switch is at off position.
21. Apparatus shall not be exposed to dripping or splashing and no objects filled with liquids, such as vases, shall be placed on the apparatus.
22. Only use attachments/accessories specified by the manufacturer.
23. An appliance with a protective earth terminal should be connected to a mains outlet with a protective earth connection.
24. An appliance should be placed in a position where an AC plug / inlet can be easily pulled out by hand.

Important Safety Instructions

- 1) Read these instructions.
- 2) Keep these instructions.
- 3) Heed all warnings.
- 4) Follow all instructions.
- 5) Do not use this apparatus near water.
- 6) Clean only with dry cloth.
- 7) Do not block any ventilation openings. Install in accordance with the manufacturer's instructions.
- 8) Do not install near any heat sources such as radiators, heat registers, stoves, or other apparatus (including amplifiers) that produce heat.
- 9) Do not defeat the safety purpose of the polarized or grounding-type plug. A polarized plug has two blades with one wider than the other. A grounding type plug has two blades and a third grounding prong. The wide blade or the third prong are provided for your safety. If the provided plug does not fit into your outlet, consult an electrician for replacement of the obsolete outlet.
- 10) Protect the power cord from being walked on or pinched particularly at plugs, convenience receptacles, and the point where they exit from the apparatus.
- 11) Only use attachments/accessories specified by the manufacturer.
- 12) Use only with the cart, stand, tripod, bracket, or table specified by the manufacturer, or sold with the apparatus. When a cart is used, use caution when moving the cart/apparatus combination to avoid injury from tip-over.



- 13) Unplug this apparatus during lightning storms or when unused for long periods of time.
- 14) Refer all servicing to qualified service personnel. Servicing is required when the apparatus has been damaged in any way, such as power-supply cord or plug is damaged, liquid has been spilled or objects have fallen into the apparatus, the apparatus has been exposed to rain or moisture, does not operate normally, or has been dropped.

Table of contents

Safety Instructions	2
Read this chapter first!	
9	
Introduction	10
MR-8HD main features	10
Precautions before using	11
About power supply	11
Precautions upon installing the MR-8HD	11
Notes on repair	11
About copyrights	11
About damages	11
Note on audio interruption	11
Notes on USB connection with Mac OS	11
The basics of the MR-8HD	12
Recording method	12
About song	13
Remain (recordable space left on the disk)	13
Time base	14
Input and repro monitor	14
TRIM control	15
Names and functions	
17	
Top panel 1	18
Top panel 2	20
Rear panel	22
LCD display	23
Home screen	23
Selecting a time base mode	24
Adjusting the display contrast	24
MENU mode screen	25
Warning message	25
Basic operations	
27	
About power	28
Power connection	28
About the standby mode	28
Turning on the unit	28
Listening the demo song	29
Connecting headphones (or monitor speaker system)	29
Playing back the demo song	30
Creating a song for recording	31

Input connection	33
Input channel	33
INPUT A SEL switch	33
Recording track combinations and available input channel(s)	34
Recording onto a single track	35
Preparation for recording	35
Starting recording	36
Playing back the recorded track	36
Undoing recording (undo/redo)	36
Overdubbing basics	37
Preparation for recording	37
Adjusting the recording levels while listening to track 1	38
Starting recording	38
Playing back recorded track	38
Undoing recording (undo/redo)	38
Recording onto four tracks simultaneously	39
Preparation for recording	39
Starting recording	40
Playing back recorded tracks	40
Undoing recording (undo/redo)	40
Basic mixdown	41
Mixdown to an analog recorder	41
Mixdown to a digital recorder	42
Advanced playback and locates functions	43
3 x cueing	44
Playback between LOCATE A and B points	44
Play mode	45
Selecting a play mode	45
Auto play mode	46
Auto return mode	46
Loop mode	46
Loop function in auto punch in/out mode	47
Locate function	48
Time locate	48
Locating to the beginning (ABS ZERO) of a song	48
Locating to the recording end point (REC END) of a song	48
Locating to the LOCATE A or LOCATE B point	49
Setting the LOCATE A or LOCATE B point	49
Locating	50
Punch in/out	51
Punch in/out using the keys on the top panel	52
Punch in/out using the footswitch	53
Auto punch in/out	54
Setting the punch-in and punch-out points	54
Rehearsal for auto punch in/out	55
Actual auto punch in/out	56

Using effects	57
Using the insert effects	58
Mic simulation effects	58
Amp simulation effects	58
Applying external effects	59
Using the reverb or delay	60
Selecting an effect type	60
Selecting a delay type	60
Adjusting the delay/reverb time	61
Adjusting the effect send levels	61
Using the mastering effects	62
Selecting the desired effect type	62
Track bouncing	63
Preliminary knowledge	64
Track bouncing example	64
Signal flow of track bouncing	65
Bouncing tracks 1 through 4 to tracks 5/6	66
Rehearsal of track bouncing	66
Actual track bouncing	67
Checking the bounced signals on tracks 5/6	67
Bouncing tracks 1 through 6 to tracks 7/8	68
Rehearsal of track bouncing	68
Actual track bouncing	69
Checking the bounced signals on tracks 7/8	69
Bouncing tracks 1 through 8 to a new song	70
Rehearsal of track bouncing	70
Actual track bouncing	71
Mixing signals of inputs A through D	72
Connecting sound sources to INPUT A through INPUT D	72
[TO STEREO BUSS ON/OFF] key setting	72
Panning setting for INPUT A through INPUT D	73
Bouncing the desired part of a song	74
Rhythm guide function	75
Using the rhythm guide function	76
Setting the time signature and tempo	76
Creating the conductor map	78
Setting the signature map	78
Editing a time signature event	80
Deleting an unnecessary time signature event	80
Editing the bar offset	81
Setting the tempo map	82
Editing a tempo event	84
Deleting an unnecessary tempo event	84

MIDI synchronization	85
Synchronization using MTC	86
Connection	86
Settings of the MR-8HD and MIDI sequencer	86
MIDI sync/MTC frame rate settings	86
Synchronization using MIDI clock	87
Connection	87
Settings of the MR-8HD and MIDI sequencer	87
Data export to a personal computer	89
WAV file conversion	90
Enabling the file conversion	90
Procedure of file conversion	90
Exporting data to a personal computer	92
Connection to a personal computer	92
Notes on exporting a file	92
Exporting a WAV file to a personal computer	93
Protecting the hard disk	94
Archiving a song	95
Song management	97
Selecting the desired song	98
Editing a song name	99
Deleting an unnecessary song	100
Protecting a song	101
Track editing	103
Erasing track data	104
Copying/pasting track data	105
Moving track data	107
Exchanging whole track data	108
Part editing	111
Playing back the "part" (Between LOCATE A and LOCATE B) to be edited.....	112
Changing an edit point during editing	112
Editing the part(s)	113
Copying/pasting the part(s)-1	114
Copying/pasting the part(s)-2	116
Copying to the clipboard	116
Pasting clipboard data	117

Moving the part(s)	119
Exchange the parts	120
Other functions	123
Hard disk formatting	124
Peak hold time setting	125
Pre-roll/post-roll time setting	126
Beat resolution mode on/off	127
Phantom power on/off	128
Initializing the MR-8HD	130
Troubleshooting	131
Trouble for recording	132
Trouble for playback	133
Trouble for effect	134
Trouble for USB connection	134
Other troubles	135
MR-8HD Specifications	137
Specifications	138
Physical dimensions	139
Block diagram	140
MIDI implementation chart	142
Index	143
Declaration of EC Directive	144

Read this chapter first!

This chapter describes precautions before using, as well as features and basic knowledge of the MR-8HD.

To understand the MR-8HD features and basic functions, read this chapter before using.

Introduction

Thank you very much for purchasing the Fostex MR-8HD digital multitracker. The MR-8HD is a digital multitracker which can record 8-track audio at 44.1 kHz/16 bits on the internal 3.5-inch hard disk. Up to four tracks can be recorded simultaneously.

The MR-8HD is also equipped with an 8-channel digital mixer, digital effects including the delay/reverb, mastering effects and insert effects (simulation effects). It allows you to carry out all the process for digital multitrack recording including overdubbing, track bouncing and mixdown within the digital domain, ensuring no loss of sound quality.

MR-8HD main features

- You can record high quality audio to the built-in high performance 3.5-inch hard disk drive (40MB).
You can also edit recorded audio later without sound deterioration.
Up to 99 songs can be recorded.
- Provides four analog input channels and up to four tracks can be recorded simultaneously.
Signals of four input channels ([INPUT A] through [INPUT D]) can be mixed to the stereo buss (Pre mastering effects).
- You can bounce all eight tracks to a new song, which is automatically created in the bouncing process.
- An ASP digital effect processor (delay/reverb) with the algorithm newly developed by Fostex is built in, allowing effect processing to tracks 1 through 4 during track bouncing.
In addition, the MR-8HD also provides insert effects for microphone and amplifier simulation for coloring sounds.
- The dedicated mastering effects are built in for the stereo buss, allowing you to process sounds during track bouncing or final mixdown.
- The adoption of self-illuminated keys allows intuitive operation.
- Phantom power is built in, allowing direct connection of condenser microphones.
- The rhythm guide function is provided.
You can make global time signature/tempo setting for a simple song or create a conductor map for a more complicate song, and output the guide click.
- Song data (on mono WAV files on tracks 7 and 8) mastered by the MR-8HD can be converted to a stereo WAV file easily.
You can export the converted file to a personal computer and create an audio CD using the CD burn function of the PC.
- The [DIGITAL OUT] port outputs S/PDIF format digital signals. You can make mixdown or digital copy to an external DAT or MD recorder.
- The whole or a part of track data can be edited (i.e. copied, pasted, moved, exported, exchanged and erased).
- The [MIDI OUT] port is provided.
You can synchronize the MR-8HD with external MIDI devices (MIDI sequencer, etc.) using MTC or MIDI clock.

Precautions before using

About power supply

- Be sure to connect the MR-8HD to the power supply specified in the specifications section of this owner's manual. Do not use an AC outlet of any other voltage.
- Do not connect the MR-8HD to the same AC outlet to which devices that could generate noise (such as a large motor or dimmer), or the devices that consume a large amount of power (such as an air conditioning system or large electric heater) are connected.
- If you use the MR-8HD in an area with a different power voltage, first consult your dealer or the nearest Fostex service station.
- The [POWER] switch cannot turn off the power completely. When this switch is "up", the MR-8HD enters standby mode (i.e. the power does not completely turned off). Therefore, if you do not use the MR-8HD for a long time, we recommend unplugging the power cord from the AC outlet.
- It is very dangerous to use a power cord that is frayed or damage. In such a case, stop using the MR-8HD immediately and ask your dealer to repair the cord.

<Important! >

Model name, power requirement, serial number and other information for the MR-8HD are shown at the bottom of the unit.

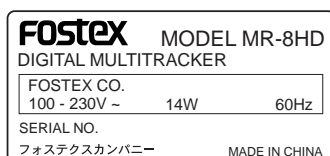

Precautions upon installing the MR-8HD

- Do not install the MR-8HD in locations subject to the following:
 - * Extremely high or low temperature, or significant changes in temperature.
 - * Excessive humidity or dust.
 - * Excessive changes in power supply voltage.
 - * Unstable or significantly vibrating or shaking surfaces.
 - * Near a strong magnetic field (such as a TV or speaker).

Notes on repair

- The MR-8HD does not use any parts that user can repair easily. Contact your dealer or the nearest Fostex service station to ask about repairs.
- Use the original packing carton of the MR-8HD when you transport or send the MR-8HD to the dealer or Fostex service station for repair. If you have discarded the packing carton, pack the MR-8HD using shock absorbing materials. Fostex is not responsible for malfunction or damage due to incomplete packaging or caused during transportation.
- Because the MR-8HD is a consumer product, Fostex does not offer on-site service or provide a loaner unit while your MR-8HD is under repair.

About copyrights

- It is prohibited by law to use any part of a CD recording or video images or audio data for which copyright is possessed by a third party for commercial purposes such as contents, broadcasts, sales, or distribution-any purpose other than for your personal pleasure.

About damages

- Fostex is not responsible for any "direct damage" or "indirect damage" caused by using the MR-8HD.

Notes on audio interruption

- If you make recording or editing to a song many times, audio may be occasionally interrupted when the song is played back, due to data fragmentation. Note that this is not a malfunction.

Note on USB connection with Mac OS

- Before you connect the MR-8HD to a Macintosh computer, make sure that the OS is Mac OS X or higher. The MR-8HD supports only Mac OS X or higher. If you connect the MR-8HD to a Macintosh computer with Mac OS lower than "OS X", song data on the MR-8HD may be damaged.

The basics of the MR-8HD

This section describes the basics of the MR-8HD you should know before using the MR-8HD.

Recording method

The MR-8HD is fitted with a 3.5-inch hard disk drive. Songs are recorded on a hard disk along with the ABS time (from 00m00s000ms to 99m59s999ms).

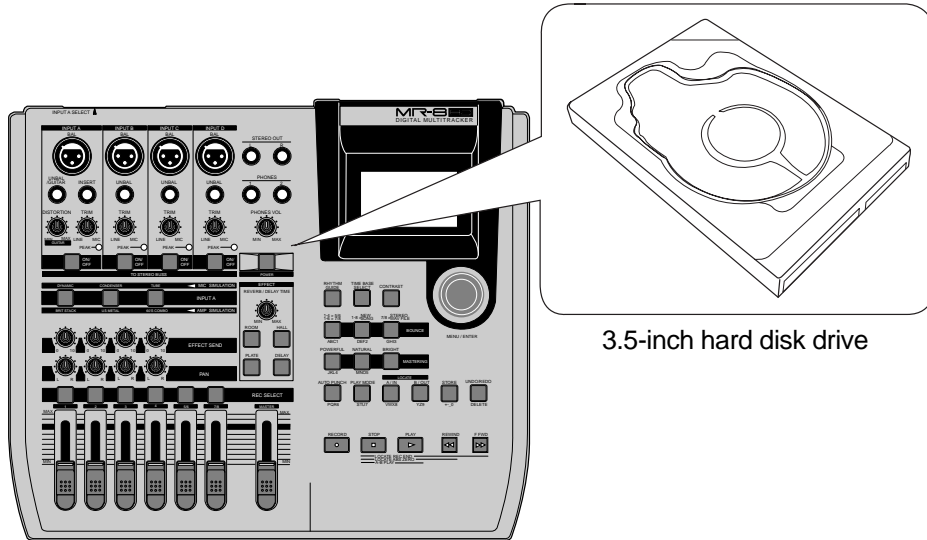

The ABS time shows the absolute time on a hard disk and you can start recording from any desired time within the range between 00m00s000ms and 99m59s999ms ABS time.

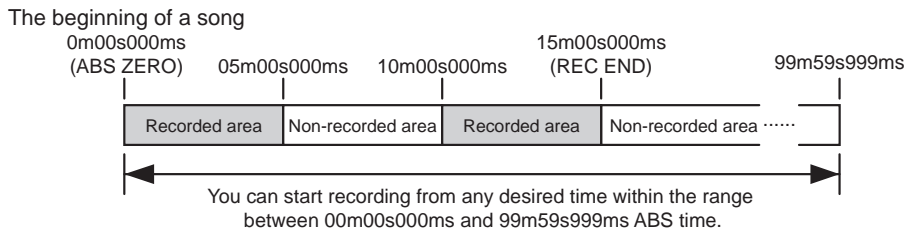

As the MR-8HD does not consume the disk space when no audio is recorded, you can record audio effectively, while the recordable time for a tape recorder depends on the tape length.

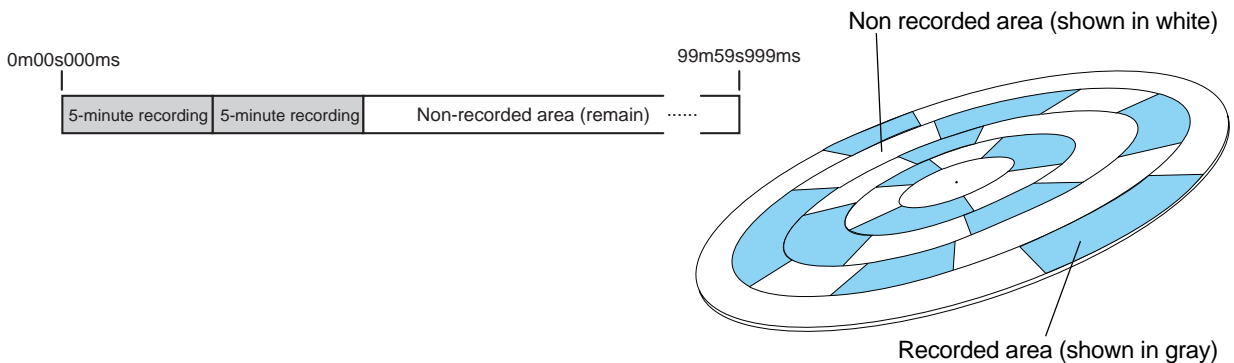

About song

To understand songs, imagine separated rooms as shown below. Each room can be regarded as a song. With the MR-8HD, you can create up to 99 rooms (songs) on the hard disk (although the available space may limit the number of songs).

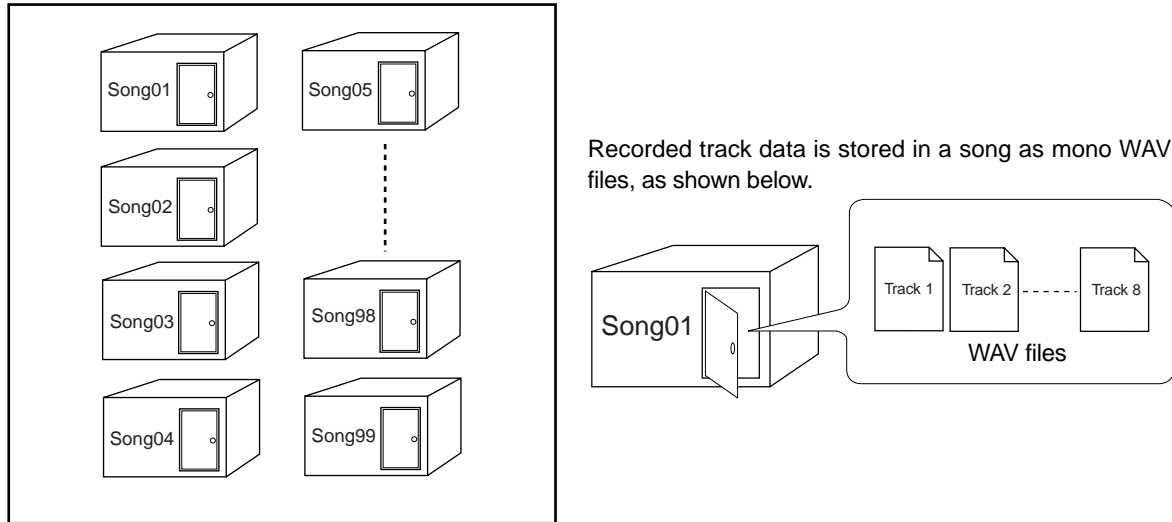

Each song is independent on a disk and you can record, play back or edit a song without affecting other songs.

You can give a desired song name for managing recorded songs (see page 99).

Recorded track data is stored in a song as mono WAV files.

The MR-8HD can convert the two WAV files recorded on tracks 7 and 8 (L and R) to a stereo WAV file (see page 90).

You can export the converted stereo WAV file to your USB-connected personal computer, and use the file by a music software application or make an original audio CD using a CD burn software application (see page 92).

Remain (recordable space left on the disk)

"Remain" shows how much time you can further record audio data to the available space left on the internal hard disk.

As described earlier, the MR-8HD stripes ABS time from 0m00s000ms to 99m59s999ms at maximum for each song. However, the remaining time (= available recording time left) depends on the available space on the hard disk in actual use. The remaining time is shown as in the screen example below during recording or record standby. Note that it shows the remaining time for recording onto a mono track.



A "mono" track means a single track. Therefore, you can calculate the remaining time for recording to more than one track by dividing the displayed time by the number of tracks. Note that the remaining time shown on the screen is an approximate time.

Time base

The term, "time base", is used as the reference of recorder position information. Using the [TIME BASE SELECT] key, you can select from among two time base modes: ABS time and bar/beat mode. Each screen example below shows the recorder is located at the beginning of a song in each time base mode.

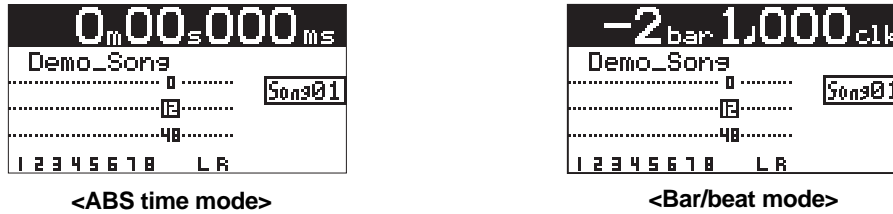

ABS time mode:

ABS time stands for Absolute time, which is "striped" on the disk when creating a song. It starts from 0m00s000ms (=ABS zero, the beginning of a song) and ends by 99m59s999ms at maximum.

Bar/beat mode:

The bar/beat/clock information is created according to the internal tempo map. The ABS zero position is set to "bar -2/beat 1/clock 000" by default (this is called "bar offset"). The MR-8HD determines the bar/beat/clock value in a song in referenced to the bar offset, as well as the time signature map and tempo map. You can set the bar offset between bar 1 to bar -8 via the menu mode (see page 81). The figure below shows the relation between two time base modes.

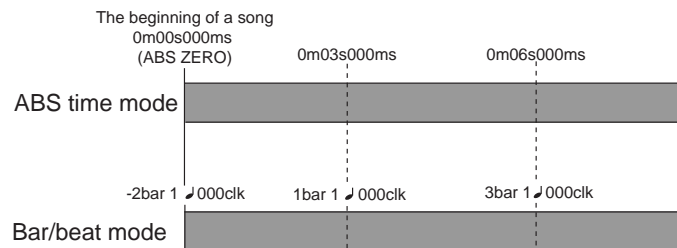

Input monitor and repro monitor

Each of the MR-8HD tracks has two output modes: repro monitor and input monitor. In the repro monitor mode, the track playback signal is output. So if you want to listen to the track playback sound, select the repro monitor mode.

In the input monitor mode, the input signal fed to the track is output. So you can check the level of the input signal to be recorded.

To enter a MR-8HD track to input monitor mode, press the appropriate [REC SELECT] key to arm the track (i.e. make the track record-ready), then press only the [RECORD] key to enter the "RECORD READY" mode or press both the [RECORD] and [PLAY] keys simultaneously to start recording.

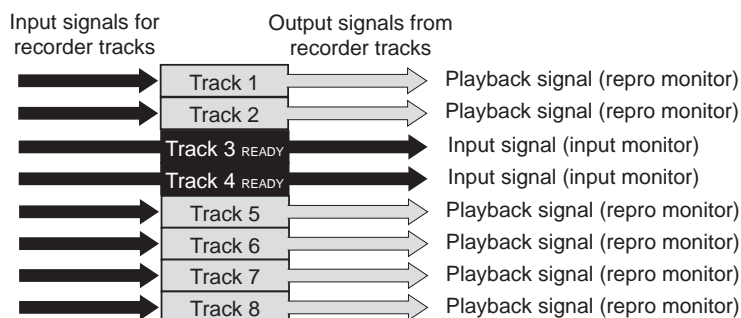

[TRIM] control

You must pay great attention to the [TRIM] control adjustment when recording to the MR-8HD.

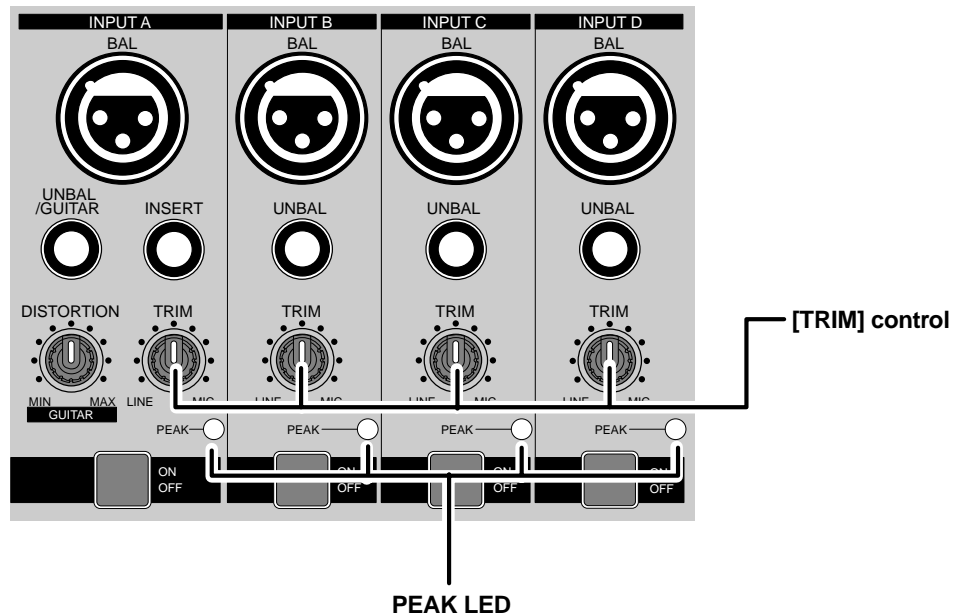

The analog signal received at each input ([INPUT A] through [INPUT D]) is sent to the TRIM control, by which the signal level fed to the A/D converter of the MR-8HD is controlled.

You can check this level by the PEAK indicator. If the level is too high, the PEAK indicator lights, while you may hear the sound distorted or noisy. This distortion (noise) generated at this stage cannot be eliminated, therefore, adjust the TRIM control properly so that the PEAK indicator does not light at the loudest part of the input signal.

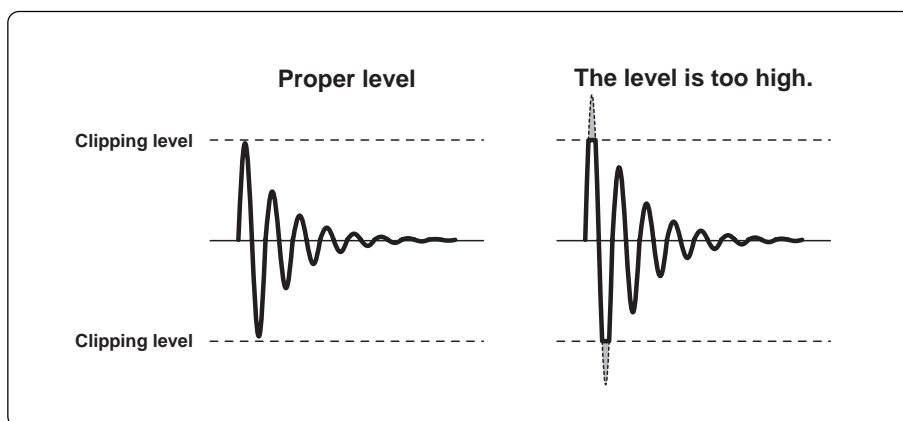

Names and functions

This chapter describes the names and functions of the controls, keys, connectors, etc. on the MR-8HD top panel and rear panel, as well as details of the display. See this chapter whenever you want to know the function of a control, key, etc.

Top panel 1

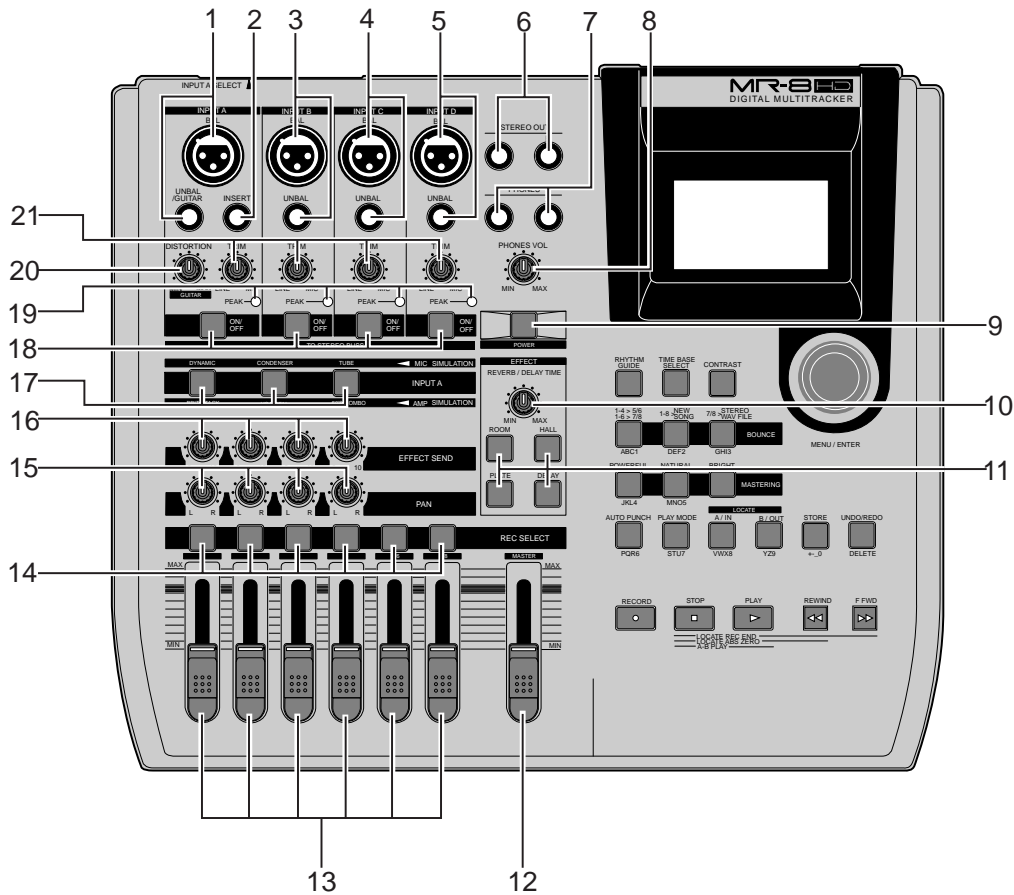

1. [INPUT A] input connectors (XLR connector and phone jack)

Both the [BAL] XLR connector and [UNBAL/GUITAR] phone jack are provided. You can connect a guitar, microphone, keyboard, etc. If you connect sources to both the XLR connector and phone jack, the phone input takes priority. When using the [INPUT A] section, select the [INPUT A SEL] switch on the rear panel appropriately according to your usage (see page 33).

2. [INSERT] connector (TRS phone jack)

Connects an external effect processor (typically, a compressor/limiter, etc.). For connection between the MR-8HD and the effect processor, use a Y-cable as shown below (see page 59).

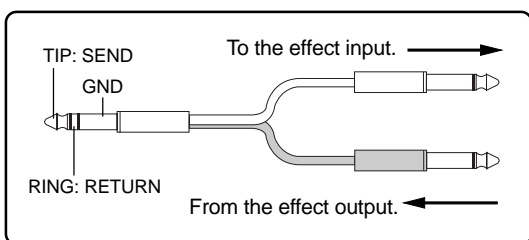

3. [INPUT B] input connectors (XLR connector and phone jack)

You can connect a guitar, microphone, keyboard, etc. to the [INPUT B] input. Both the [BAL] XLR connector and [UNBAL] phone jack are provided so you can use the appropriate connector according to the sound source. If you connect sources to both the XLR connector and phone jack, the phone input takes priority (see page 33).

4. [INPUT C] input connectors (XLR connector and phone jack)

You can connect a guitar, microphone, keyboard, etc. to the [INPUT C] input. Both the [BAL] XLR connector and [UNBAL] phone jack are provided so you can use the appropriate connector according to the sound source. If you connect sources to both the XLR connector and phone jack, the phone input takes priority (see page 33).

5. **[INPUT D] input connectors (XLR connector and phone jack)**
You can connect a guitar, microphone, keyboard, etc. to the [INPUT D] input. Both the [BAL] XLR connector and [UNBAL] phone jack are provided so you can use the appropriate connector according to the sound source. If you connect sources to both the XLR connector and phone jack, the phone input takes priority (see page 33).
6. **[STEREO OUT] jacks (L, R)**
These jacks output the stereo (L and R) buss signals. Connect these jacks to the monitoring equipment or master recorder (see pages 29 and 41).
7. **[PHONES] jacks (1, 2)**
Two jacks (1 and 2) are provided. You can use two pairs of stereo headphones with the MR-8HD (see page 29).
8. **[PHONES VOL] control**
Adjusts the headphone output level (see page 30).
9. **[POWER] switch**
Switches between standby mode and power on (see page 28). To turn off the power when the power is on, press and hold down the [POWER] switch for a few seconds.

<Note>: This switch cannot turn off the power completely. When this switch is "up", the MR-8HD enters standby mode (i.e. the power does not completely turned off). Therefore, if you do not use the MR-8HD for a long time, we recommend unplugging the power cord from the AC outlet.
10. **[REVERB/DELAY TIME] control**
This control adjusts the reverb time or delay time. When you select "ROOM", "HALL" or "PLATE" for the effect type, it adjusts the reverb time. When you select "DELAY", it adjusts the delay time. (See page 61.)
11. **[EFFECT] keys**
These keys are used to select the effect type. You can select from three reverb types (ROOM, HALL and PLATE) and a delay (DELAY). The selected key is lit (see page 60).
12. **[MASTER] fader**
Adjusts the stereo (L and R) buss output level (see pages 30 through 39).
13. **Track faders**
Each fader adjusts the track playback level. Each of track faders 5/6 and 7/8 controls the stereo signal (see pages 30 through 39).
14. **[REC SELECT] keys**
Used to select the recording track(s). You can record onto up to four tracks simultaneously. Pressing a key arms or unarms the corresponding track(s). Tracks 5/6 or 7/8 are armed or unarmed simultaneously (see pages 35 through 42).
15. **[PAN] controls**
Control panning for tracks 1 through 4.
16. **[EFFECT SEND] controls**
Control the amount of signals from tracks 1 through 4 sent to the internal effect (reverb or delay) (see page 61).
17. **Insert effect selection keys**
Used to select the insert effect (mic simulation or amp simulation) for the signal from the [INPUT A] jack.
When setting the [INPUT A SELECT] switch on the rear panel to "MIC/LINE", you can use the mic simulation effect. When setting the switch to "GTR/DIST", you can use the guitar amp simulation effect (see page 58).
18. **[TO STEREO BUSS ON/OFF] keys**
Each key selects whether or not sending the corresponding input signal to the stereo L/R busses (see page 72). Each press of the key alternates ON and OFF. When ON, the key illuminates in green. When OFF, it is unlit. When the corresponding input is assigned to a recording track, the key flashes in green.
A long press of the key enters the input menu of the MENU mode, in which you can set phantom power on/off, panning, etc. (see page 128).
19. **[PEAK] indicators**
Each indicator lights when the input signal is overloaded (see page 15). You should adjust the input gain using the [TRIM] control so that the [PEAK] indicator does not light.
20. **[DISTORTION] control**
Controls the amount of the distortion effect for a guitar connected to the [XLR] connector or [UNBAL/GUITAR] jack (phone type) on the [INPUT A] channel.
This control is effective only when the [INPUT A SEL] switch is set to "GTR/DIST" (see pages 35 through 40).
21. **[TRIM] controls**
Each control adjusts the input gain of the corresponding input channel (see page 15, and 35 through 40).

Top panel 2

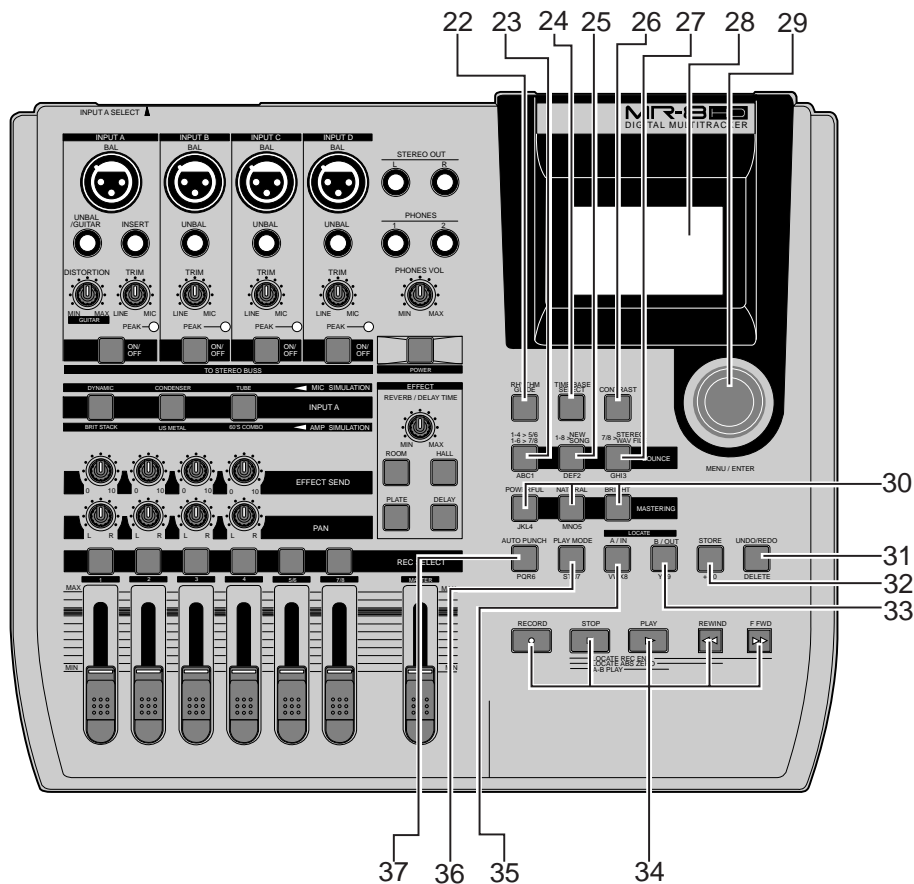

22. [RHYTHM GUIDE] key

Switches on/off of the rhythm guide function (see page 76). Each press of the switch alternates on and off. A long press of the key enters the rhythm guide menu, in which you can set the rhythm guide parameters (see page 76).

23. [BOUNCE 1-4 > 5/6, 1-6 > 7/8] / ABC1 key

Selects the bounce mode (see page 63). In the menu mode, this key is used for character entry of A, B, C, a, b, c and 1 (see pages 32 and 99).

24. [TIME BASE SEL] key

Selects the time base shown on the display (see page 24). Each press of the key switch between "time" and "bar/beat".

25. [BOUNCE 1-8 > NEW SONG] / DEF2 key

Selects the bounce mode (see page 63). In the menu mode, this key is used for character entry of D, E, F, d, e, f and 2 (see pages 32 and 99).

26. [CONTRAST] key

By rotating the [MENU/ENTER] knob while holding down this key, you can adjust the display contrast (see page 24).

27. [7/8 > STEREO WAV FILE] /GHI3 key

This key is used when converting a mono WAV file recorded on tracks 7/8 to a stereo WAV file (see page 90).

You can export the stereo WAV file to your personal computer over the USB connection (see page 92).

In the menu mode, this key is used for character entry of G, H, I, g, h, i and 3 (see pages 32 and 99).

28. LCD display

This 132 x 64 dot LCD display shows various information (see page 23).

29. [MENU/ENTER] rotary/push knob

Pressing this knob enters the menu mode. In the menu mode, rotating this knob selects the item or numeric value, while pressing this knob confirm the setting/selection.

30. [MASTERING (POWERFUL/NATURAL/ BRIGHT) keys

Used to select the desired mastering effect during track bounce or mixdown. You can select from three effect types by pressing an appropriate key (see page 62).

In the menu mode, the [POWERFUL] key is used for character entry of J, K, L, j, k, l and 4, while the [NATURAL] key is used for character entry of M, N, O, m, n, o and 5 (see pages 32 and 99).

31. [UNDO/REDO]/[DELETE] key

Used to undo or redo recording or editing (see pages 36, 38, 40).

Each press of the key alternates "undo" and "redo". In the menu mode, this key is used for deleting a character (see pages 32 and 99).

32. [STORE]/+/_ 0 key

Stores the current recorder position (time data) as the LOCATE A/IN or LOCATE B/OUT point (see pages 49 and 54).

In the menu mode, this key is used for character entry of +, -, _ and 0 (see pages 32 and 99).

33. [LOCATE B/OUT]/GHI3 key

Pressing this key while holding down the [STORE] key sets the LOCATE B point (or punch out point) (see page 49 and 54).

In the menu mode, this key is used for character entry of G, H, I and 3 (see pages 32 and 99).

34. Transport keys**[PLAY] key**

Starts playback of the recorder.

Pressing this key while holding down the [RECORD] key starts recording of the armed (record-ready) track(s).

Pressing this key during recording exits recording.

[STOP] key

Stops the recorder.

By pressing the [PLAY], [REWIND] or [F FWD] key while holding down the [STOP] key, you can locate to a specific point or repeat playback as below.

• [STOP] + [PLAY] (A-B PLAY)

Repeats playback between the LOCATE A and LOCATE B points (see page 44).

• [STOP] + [REWIND] (LOCATE ABS ZERO)

Locates to the beginning (ABS ZERO) of the current song (see page 48).

• [STOP] + [F FWD] (LOCATE REC END)

Locates to the recording end of the current song (REC END) (see page 48).

[RECORD] key

Pressing the [PLAY] key while holding down the [RECORD] key starts recording of the armed (record-ready) track(s).

By pressing only the [RECORD] key when any track(s) is armed (in record-ready), the input signal(s) of the armed track(s) can be monitored (i.e. input monitor mode). (see pages 35 through 40).

[F FWD] key

Pressing this key fast forwards the recorder. During playback, pressing this key starts 3 x cueing (see page 44).

While holding down the [STOP] key, pressing this key locates to the recording end of the current song (REC END) (see page 48).

[REWIND] key

Pressing this key rewinds the recorder.

During playback, pressing this key starts 3 x reverse cueing (see page 44).

While holding down the [STOP] key, pressing this key locates to the beginning (ABS ZERO) of the current song (see page 48).

This key is also used to go up the menu screen layer while a menu screen is displayed.

35. [LOCATE A/IN]/VWX8 key

Pressing this key while holding down the [STORE] key sets the LOCATE A point (or punch in point) (see page 49 and 54).

In the menu mode, this key is used for character entry of V, W, X, v, w, x and 8 (see pages 32 and 99).

36. [PLAY MODE]/STU7 key

Selects a play mode. You can select from among normal, auto play, auto return and loop (see page 45).

In the menu mode, this key is used for character entry of S, T, U, s, t, u and 7 (see pages 32 and 99).

37. [AUTO PUNCH]/PQR6 entry key

Turns on or off the auto punch mode (see page 55).

In the menu mode, this key is used for character entry of P, Q, R, p, q, r and 6 (see pages 32 and 99).

Rear panel

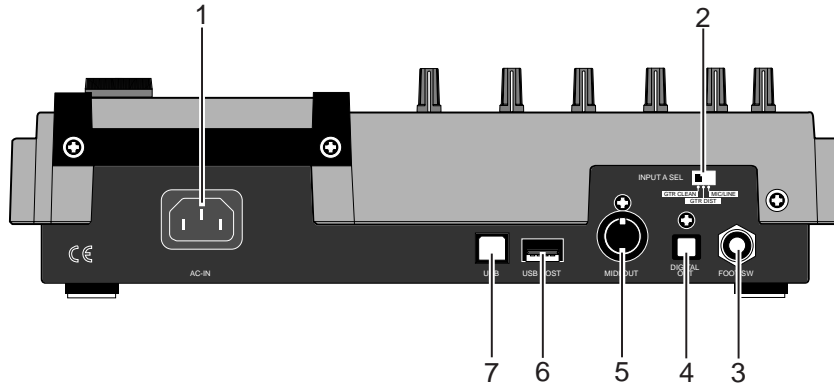

1. **[AC IN] connector**
Connect the supplied power cord to this connector (see page 28).
2. **[INPUT A SELECT] switch**
This switch must be set appropriately according to the input source of the [INPUT A] channel (see page 33).

MIC/LINE	Either of the [BAL] XLR and [UNBAL/GUITAR] phone connectors can be used. Set the switch to this position when the source is an external microphone or line level source.
GTR DIST	Either of the [BAL] XLR and [UNBAL/GUITAR] phone connectors can be used. You can adjust the input level and distortion using the [TRIM] and [DISTORTION] controls respectively. You can also use the amp simulation insert effect.
GTR CLEAN	Either of the [BAL] XLR and [UNBAL/GUITAR] phone connectors can be used. You can adjust the input level using the [TRIM] control. You can also use the amp simulation insert effect.

3. **[FOOT SW] jack (TRS phone jack)**
Used to connect with an unlatched-type footswitch (see page 53).

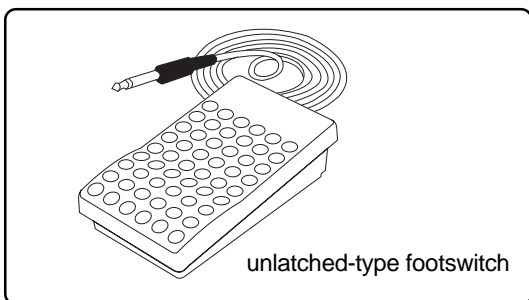

4. **[DIGITAL OUT] connector (Toslink optical connector)**
Used to connect with an external digital device using an optical cable (see page 42).

<Note>: The dust protection cap is inserted to the [DIGITAL OUT] connector when the unit is shipped. Remove the cap when you use this connector. If you do not use this connector, attach the dust protection cap.

If you need to connect the unit to a digital device which only provides a coaxial type digital connector (typically, an RCA pin jack), use the Fostex COP-1/96k coaxial-optical converter (shown right).

Model COP-1/96k

Use an optical digital cable with Toslink plugs on both ends.

5. **[MIDI OUT] jack (DIN 5-pin connector)**
Used to connect to a MIDI IN jack of an external MIDI device (such as a MIDI sequencer) (see page 86).
6. **[USB HOST] connector (USB A type)**
Prepared for the future expansion.

<Caution>: Do not connect your personal computer to the [USB HOST] port.

7. **[USB] port (USB B type)**
Used to connect with a personal computer using a standard USB cable for song file data transfer between the MR-8HD and the personal computer (see page 92).

LCD display

The following describes details about the LCD display, including screen contents and operation.

Home screen

When turning on the MR-8HD, the display shows the startup screen (showing the startup status of the MR-8HD), followed by the "home" screen, which is similar to the one below. In this condition, the previously loaded song is loaded and the recorder is located at the beginning of the song. The home screen provides the following information.

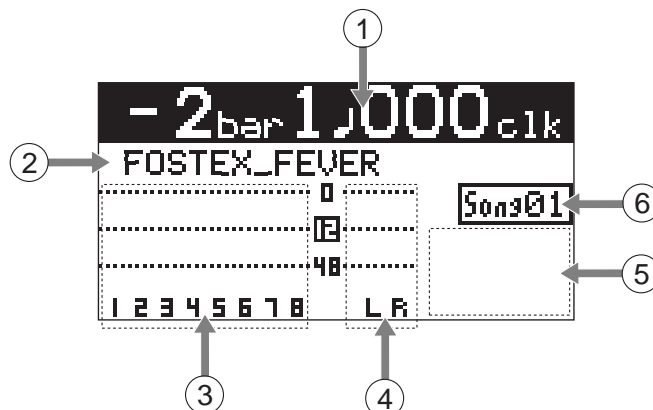

1. Time counter display

Time information of the current recorder position is shown in ABS or bar/beat mode (by default, bar/beat). Using the [TIME BASE SELECT] key, you can select a desired time base mode. When the recorder is moving (playing back, fast forwarding, etc.), the appropriate icon is also shown. While the hard disk drive is in access, "[ACC]" lights up.

2. Character display

Normally, the name of the song currently loaded is shown (up to 16 characters can be shown at a time).

It also shows following information.

- A name of the operation mode currently being executed (such as "BOUNCE 1-6->7/8).
- A (not-so-serious) warning message
- The "Remain" time when at least one track is record-armed (i.e. At least one of the [REC SELECT] keys is active).



The remain time shows how much time you can further record audio data onto a mono track using the available space left on the hard disk.

3. Track level display

The recording or playback levels of tracks 1 through 8 are shown. When a track is record armed, the track number indication changes to the source input channel (any of A, B, C and D).

4. Stereo buss (L and R) level display

During recording or playback, the output levels of the L/R stereo buss are shown.

5. Song status display

Lights up the following status icons when the appropriate modes (functions) are active.

INPUT MONI	At least one of the tracks is in the input monitor mode (see pages 36, 38 and 40).
AUTO PUNCH	The auto punch mode is active (see page 55).
AUTO RTN	The auto return mode is active (see page 45).
LOOP	The loop mode is active (see page 45).
AUTO P-	The auto play mode is active (see page 45).

6. Song number display

Shows the song number of the song currently loaded. Also, "[P]" is lit when the phantom power is on.

Selecting a time base mode

When the display shows the home screen, pressing the [TIME BASE SELECT] key switches the time base mode between ABS and bar/beat.

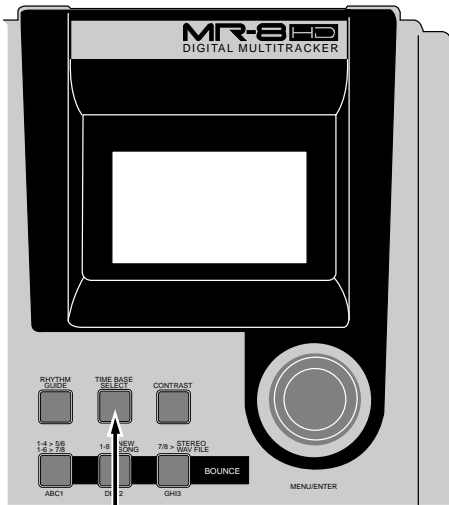

[TIME BASE SELECT] key

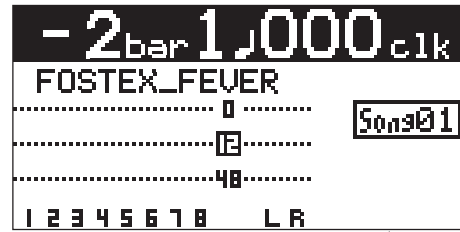

Example of bar/beat display

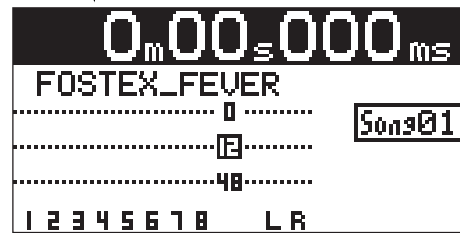

Example of ABS display

Adjusting the display contrast

You can adjust the display contrast by rotating the [MENU/ENTER] knob while holding down the [CONTRAST] key. Rotating the dial clockwise heightens the contrast, while rotating it counterclockwise lowers the contrast.

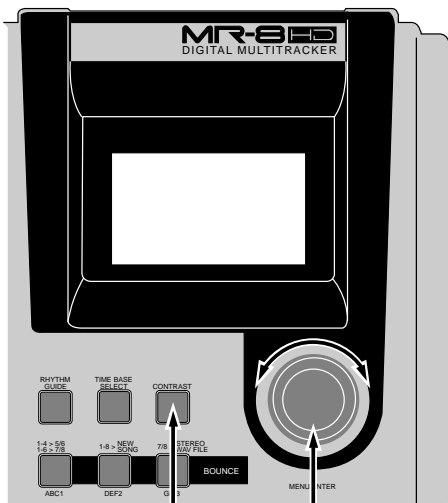

[CONTRAST] key

[MENU/ENTER] knob

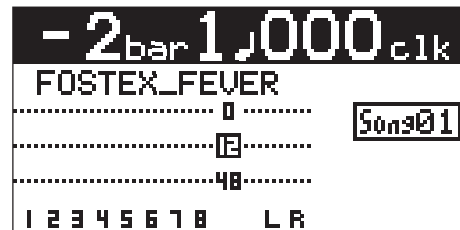

High contrast



Low contrast

While pressing down the [CONTRAST] key, the display shows "CONTRAST -> DIAL".



MENU screen

Pressing the [MENU/ENTER] knob while the recorder is stopped enters the menu mode and brings up the menu screen.

In the menu mode, you can make setting or editing via the appropriate screen. The top menu screen has two pages, in which you can select the desired menu by rotating the [MENU/ENTER] knob.



[MENU/ENTER] knob

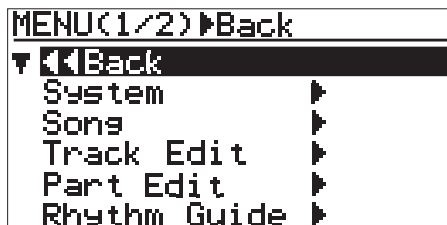

First page

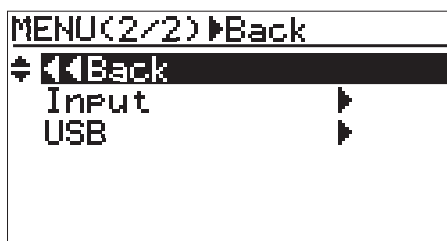

Second page

Warning message

If a serious problem happens to the MR-8HD during operation, an appropriate warning message is shown on the display. Most warning messages are being shown until the [MENU/ENTER] knob is pressed. Note that there are also not-so-serious warning messages besides the following.

This message is shown when you are going to delete a song which is protected.



During recording, this message is shown if there is no more space left on the hard disk for recording.

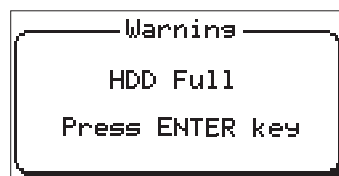

This message is shown when the hard disk drive has a problem.

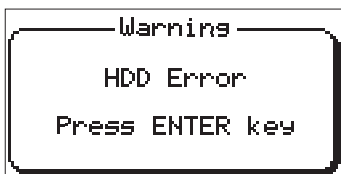

This message is shown when you are going to make recording or editing to a song which is protected.

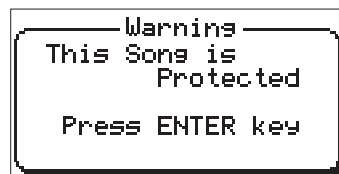

This message is shown when you are going to edit a track or part but there is not enough space on the hard disk for executing the undo function.

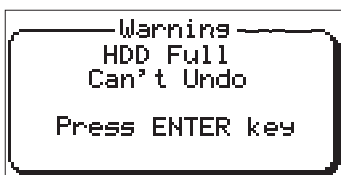

This message is shown when you are going to create a new song while 99 songs exist on the hard disk.

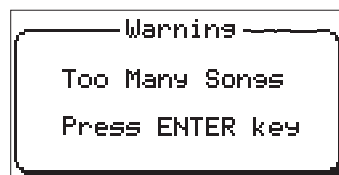

Basic operations

This chapter describes power connection, power on/off, demo song playback, etc., as well as basic multitrack recording.

If it is the first time for you to use a Multitracker, read this chapter carefully first so that you are familiar with the MR-8HD basic operations, then read other sections which describe advanced operations.

About power

The MR-8HD operates by AC power. Before you start using the MR-8HD, you must connect the supplied power cord.

Power connection

Connect between the [AC IN] connector on the MR-8HD rear panel and an AC outlet using the supplied power cord. The MR-8HD enters the standby mode when the power cord is connected.

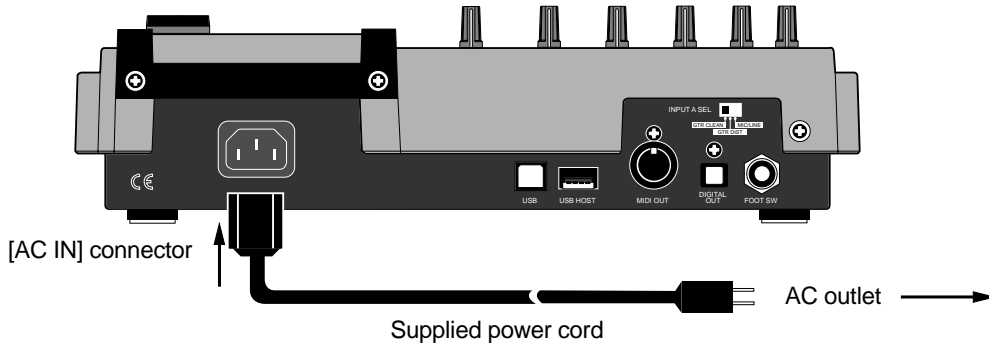

About the standby mode
 The standby mode is the condition when the power cord is connected and the [POWER] switch is set to OFF. In the standby mode, a small amount of power is consumed and the indicator of the [POWER] switch flashes slowly.

<Note>: When you do not operate the MR-8HD for a long period of time, we recommend disconnecting the power cord.

Turning on the unit

You can turn on or off the MR-8HD power using the [POWER] switch (pointed by an arrow below). To turn off the power, press and hold down the [POWER] switch for a few seconds.

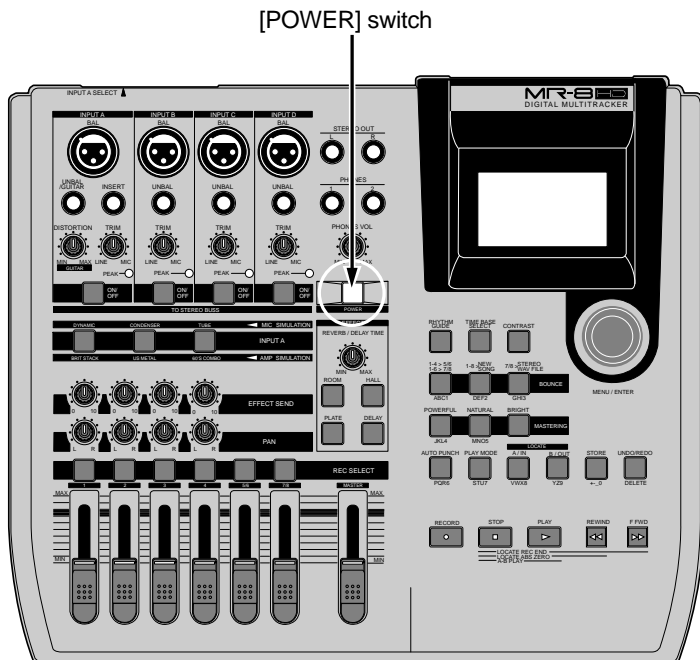

When you press the [POWER] switch to turn on the power for the first time, the MR-8HD starts up and the display shows the screen as below (note that it takes some time until the screen as below is shown).

This screen shows that the demo song is loaded and stopped at the beginning (ABS 0) of the song named "FOSTEX_FEVER".



Follow the procedure described on the next page to playback the demo song.

Listening the demo song

A demo song is pre-recorded on the hard disk of the MR-8HD when shipped. Before you make recording, let's listen to the demo song via headphones (or a monitor speaker).

Connecting headphones (or a monitor speaker system)

Connect headphones to either of the two [PHONES] jacks of the MR-8HD. Both jacks feed the same signal so you may connect headphones whichever you like.

If you have a powered monitor speaker, you may connect it to the [STEREO OUT] jacks of the MR-8HD.

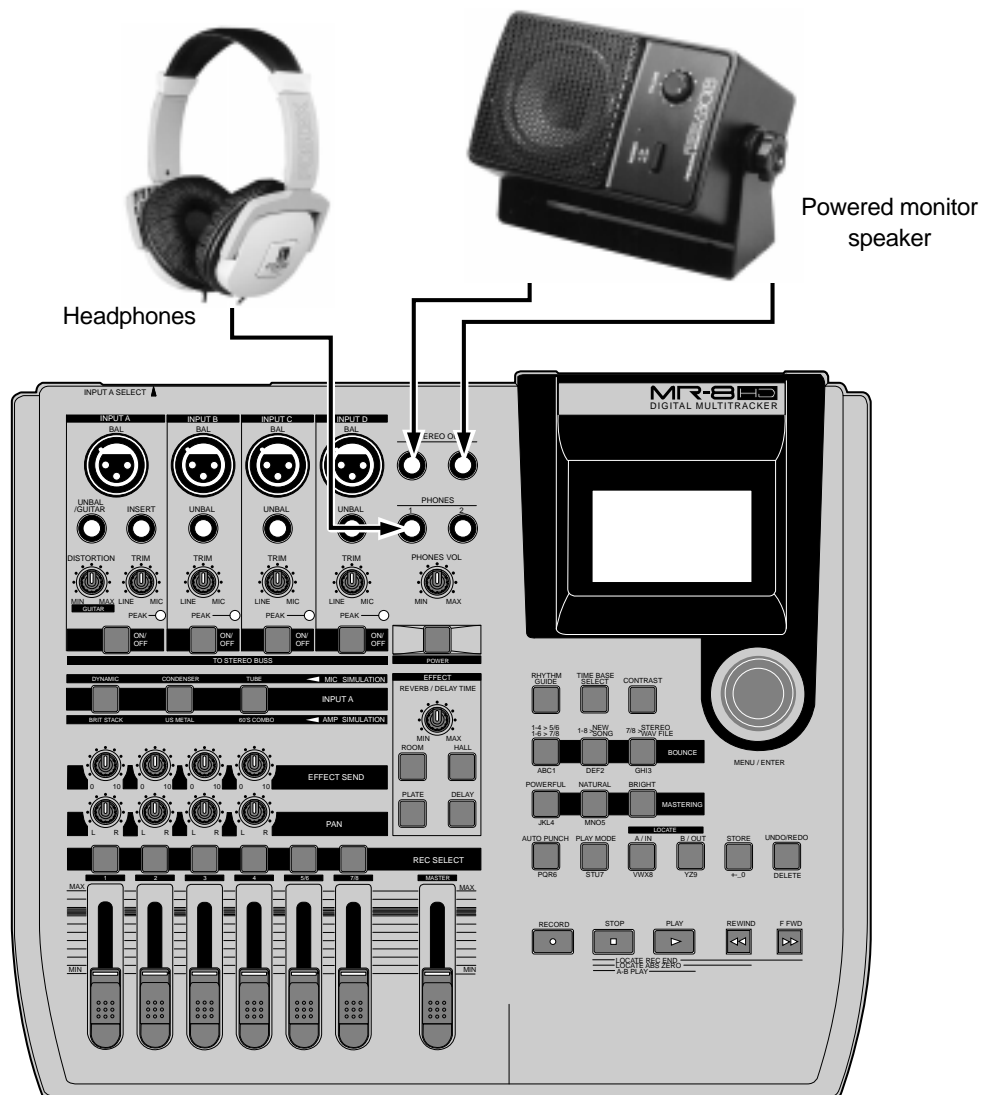

<Note>: You can plug a 1/4" phone plug to the [STEREO OUT] L or R jack.



<Note>: When you connect a powered monitor speaker to the unit, turn down the volume of the powered monitor speaker to minimum before you turn on the MR-8HD and the powered monitor speaker.

Playing back the demo song

In the demo song, approximately 1-minute audio is recorded on all eight tracks. Follow the procedure below for listening to the demo song. In the following procedure, it is assumed that the MR-8HD is turned on and a pair of headphones (or a monitor speaker system) is connected.

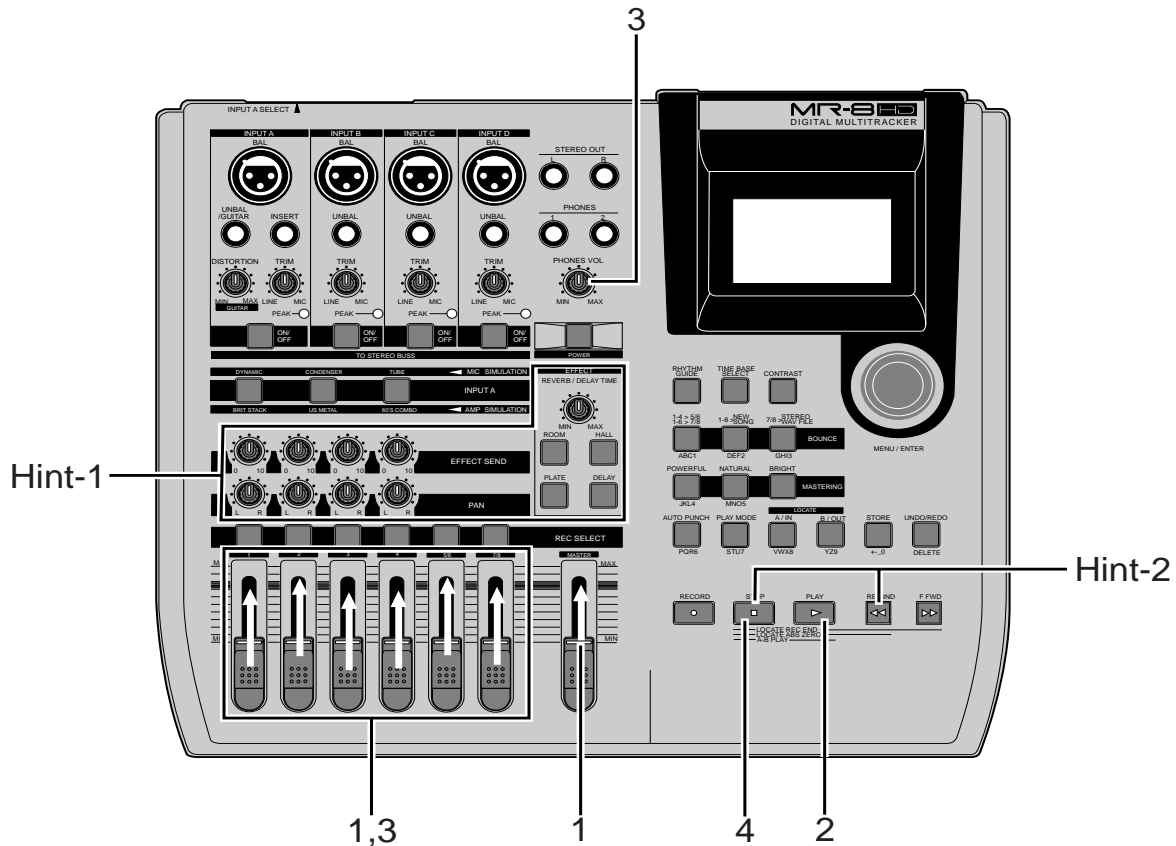

- 1) Raise the [MASTER] fader to the "≡" position. Set the track faders at the lowest position.
- 2) Press the [PLAY] key to start playback.
- 3) Raise the track faders (1 through 8) gradually to adjust the playback level and balance. Also raise the [PHONES VOL] control gradually to adjust the headphones level. (If you are using a powered monitor speaker for monitoring, adjust the level control of the powered speaker.)
- 4) When the demo song ends, press the [STOP] key to stop the recorder.

<Hint-1>: While listening to the playback sound, adjust panning setting of tracks 1 through 4, as well as try to adjust the internal effects (reverb/delay) (see page 60).

<Hint-2>: To listen to the demo song again: When the recorder is stopped after listening to the demo song, press the [REWIND] key while holding down the [STOP] key. The recorder instantly moves back to the beginning of the demo song (see page 48). Then pressing the [PLAY] key starts playback from the beginning of the demo song.

<Note>: The demo song is protected and you cannot overwrite or erase it. Therefore, you cannot make recording in this condition. If you want to make new recording while keeping the demo tape on the hard disk, see "Creating a song for recording" on the next page. If you do not keep the demo song, carry out either of the following operations.

- (1) **Release the song protection (see page 101).**
Then, start recording (overwrite recording) from the beginning of the demo song, or delete the demo song from the hard disk. If you delete the demo song, create a new song (see the next page) and make recording to the new song.
- (2) **Format the hard disk (see page 124) and make recording.**
Because a new song is automatically created after formatting the disk, you can start recording without the need of creating a new song manually.

Creating a song for recording

This section describes how to create a new song for recording on the hard disk, while keeping the demo song. In the following procedure, it is assumed that the MR-8HD is stopped at the beginning (ABS ZERO) of the demo song.

- 1) While the recorder is stopped, press the [MENU/ENTER] knob to enter the menu mode.

The display now shows the first page of the menu selection screen, where "<< Back" is highlighted initially.

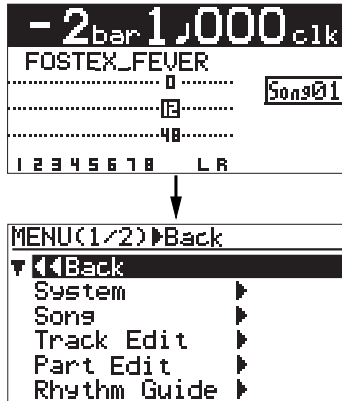

<Note>: By selecting "<< Back" and pressing the [MENU/ENTER] knob, the display returns to the previous screen. You can also return the display to the previous screen by pressing the [REWIND] key.

- 2) Rotate the [MENU/ENTER] knob to select "Song", and press the [MENU/ENTER] knob.

The display now shows the first page of the song menu screen, where "<< Back" is highlighted initially.

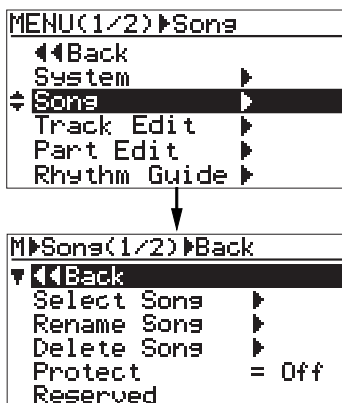

- 3) Rotate the [MENU/ENTER] knob to select "Select Song", and press the [MENU/ENTER] knob.

The display now shows the first page of the song selection screen. You can see the list of the song numbers/names on the hard disk. Currently, only the demo song is created, and "S01: FOSTEX_FEVER" and "---:(New Song)" are shown.

"---:(New Song)" is used to create a new song.

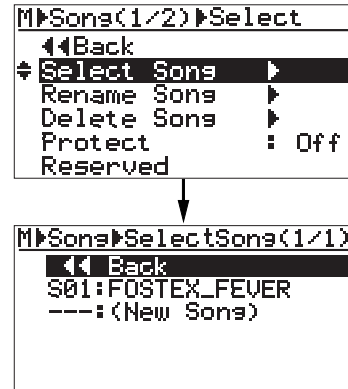

- 4) Rotate the [MENU/ENTER] knob to select "---:(New Song)", and press the [MENU/ENTER] knob.

The display now shows the screen for entering a new song name. The rightmost character on the default song name is flashing (in the example below, "2" of "Song02" starts flashing).

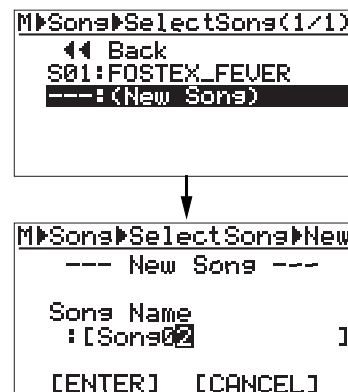

- 5) Enter the desired song name.

Use the character entry keys to enter the desired character at the flashing point. Rotate the [MENU/ENTER] knob to move the flashing point. Use the [UNDO/REDO/DELETE] key to delete the character at the flashing point. Therefore, when the rightmost character is flashing as in the screen example above, you can delete all characters by pressing the [UNDO/REDO/DELETE] key repeatedly. You can enter up to 16 characters for a song name.

See <How to enter characters> on the next page for entering the song name as "My_Song".

<Note>: You may leave the default song name as it is. Also, you can edit the song name after creating a song using the "Rename Song" menu item in the song menu of the menu mode (see page 99).

<How to enter characters>**<Character entry keys>**

Some keys on the MR-8HD top panel act as character entry keys in the menu mode. For example, the [PLAY MODE] key (shown at the left) can be used for entering S, T, U, s, t, u and 7. Each press of a character entry key switches the character to be entered among those assigned to the key.

**<Character entry example>**

The following procedure example shows how to enter "My_Song" as a song name.

1. Use the [NATURAL] key to enter "M".
2. Use the [LOCATE B/OUT] key to enter "y".
3. Use the [STORE] key to enter "_".
4. Use the [PLAY MODE] key to enter "S".
5. Use the [NATURAL] key to enter "o".
6. Rotate the [MENU/ENTER] knob to move the cursor right.
7. Use the [NATURAL] key to enter "n".
8. Use the [7/8>STEREO WAV FILE] key to enter "g".

<Notes on cursor movement>

Pressing a different character entry key automatically moves the cursor right.

If two successive characters are assigned to the same character entry key, rotate the [MENU/ENTER] knob after selecting the first character to move the cursor right.

- 6) **After completing song name entry, press the [MENU/ENTER] knob.**

The cursor moves to "[ENTER]" at the bottom of the screen.

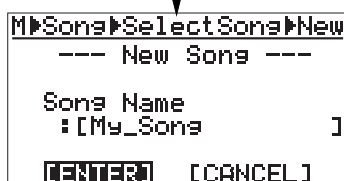
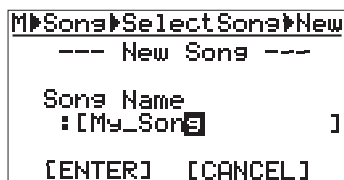

<Note>: If you want to cancel creating a song, rotate the [MENU/ENTER] knob to move the cursor to "[CANCEL]" and press the [MENU/ENTER] knob.

- 7) **While "[ENTER]" is flashing, press the [MENU/ENTER] knob.**

The display now shows the home screen of the newly created song (My_Song).

As shown in the lower screen example, the song name (My_Song) and the song number (Song02) are shown.

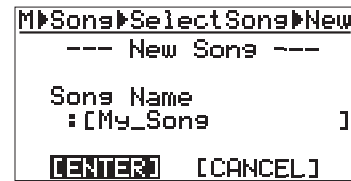

Now, in addition to the demo song, a new song on which no audio is recorded is created by the procedure above.

It is a good idea to create more than one song before you start recording.

After creating a song or songs for recording, connect the sound source to the MR-8HD (see the next page) and start recording.

<Note>: After creating a new song, by executing procedure steps 1 through 3, the following song selection screen appears. This screen is used for loading the desired song from the list, as well as creating a new song.

For example, by rotating the [MENU/ENTER] knob to highlight "S01: FOSTEX_FEVER" and pressing the [MENU/ENTER] knob, you can load the demo song.

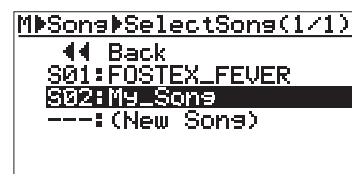

For details about how to select the desired song, see "Song management" on page 97.

Input connection

Input channel

The MR-8HD provides four input channels: [INPUT A], [INPUT B], [INPUT C] and [INPUT D]. Each channel provides both the XLR and 1/4" phone connectors.

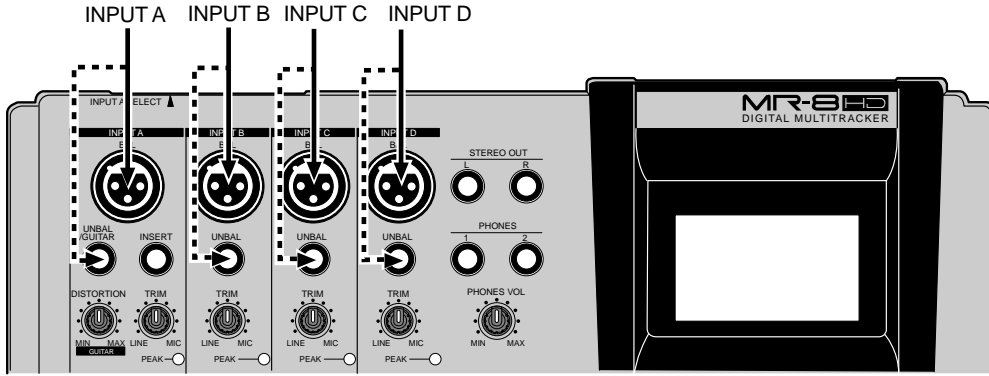

Input channel	Available input connectors	Shapes of connectable connector
INPUT A INPUT B INPUT C INPUT D	Either of the XLR (balanced) connector or phone (unbalanced) jack can be used (if both connectors are plugged, the phone jack is effective).	<div style="display: flex; justify-content: space-around; margin-top: 5px;"> XLR-3-12C type PHONE plug </div>
<ul style="list-style-type: none"> When you use the [INPUT A] channel, set the [INPUT A SEL] switch on the rear panel appropriately. If you use a condenser microphone, use the XLR (balanced) connector. The MR-8HD can supply the phantom power (see page 128). 		

INPUT A SEL switch

When you use the [INPUT A] channel, you must set the [INPUT A SEL] switch on the rear panel appropriately.

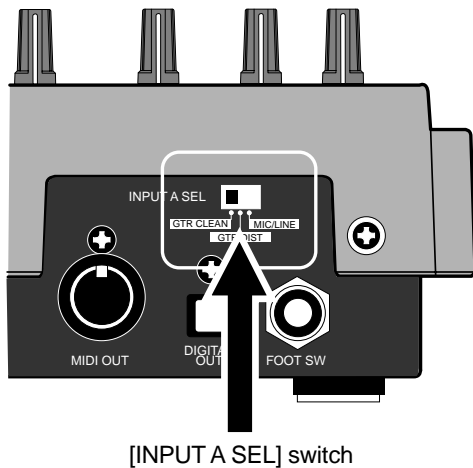

<p style="text-align: center;">“MIC/LINE” position</p>	<p>Both the [BAL] XLR and [UNBAL/GUITAR] phone connectors can be used. Set the switch to this position when the source is an external microphone or line level source.</p>
<p style="text-align: center;">“GTR DIST” position</p>	<p>Both the [BAL] XLR and [UNBAL/GUITAR] phone connectors can be used. You can adjust the input level and distortion using the [TRIM] and [DISTORTION] controls respectively. You can also use the amp simulation insert effect.</p>
<p style="text-align: center;">“GTR CLEAN” position</p>	<p>Both the [BAL] XLR and [UNBAL/GUITAR] phone connectors can be used. You can adjust the input level using the [TRIM] control. You can also use the amp simulation insert effect.</p>

Recording track combinations and available input channel(s)

The following shows the recording track combinations and available input channel(s) by the number of tracks simultaneously recorded.

Recording to a single track	
	Track 1
	Track 2
	Track 3
	Track 4
<p>Only [INPUT A] is available. You can record only the [INPUT A] channel signal to the selected track. The channels from [INPUT B] to [INPUT D] are not available.</p>	

Recording to three tracks simultaneously	
	Trk 1, 2 and 3
	Trk 1, 2 and 4
	Trk 1, 3 and 4
	Trk 1, 5 and 6
	Trk 1, 7 and 8
	Trk 2, 3 and 4
	Trk 2, 5 and 6
	Trk 2, 7 and 8
	Trk 3, 5 and 6
	Trk 3, 7 and 8
	Trk 4, 5 and 6
	Trk 4, 7 and 8
<p>[INPUT A], [INPUT B] and [INPUT C] are available. The [INPUT A] channel signal is assigned to the track with the lowest number, the [INPUT B] signal assigned to the track with the next lowest number, and the [INPUT C] signal is assigned to the track with the highest number.</p>	

<Example of input assignment to tracks>
 If you make recording to tracks 2, 4, 7 and 8, input-to-track assignment is as follows.

INPUT A -> Track 2
INPUT B -> Track 4
INPUT C -> Track 7
INPUT D -> Track 8

Recording to two tracks simultaneously	
	Trk 1 and 2
	Trk 3 and 4
	Trk 5 and 6
	Trk 7 and 8
	Trk 1 and 3
	Trk 1 and 4
	Trk 2 and 3
	Trk 2 and 4
<p>[INPUT A] and [INPUT B] are available. The [INPUT A] channel signal is assigned to the track with the lower number, while the [INPUT B] channel signal is assigned to the track with the higher number.</p>	

Recording to four tracks simultaneously	
	Trk 1, 2, 3 and 4
	Trk 1, 2, 5 and 6
	Trk 1, 2, 7 and 8
	Trk 3, 4, 5 and 6
	Trk 3, 4, 7 and 8
	Trk 1, 3, 5 and 6
	Trk 1, 3, 7 and 8
	Trk 1, 4, 5 and 6
	Trk 1, 4, 7 and 8
	Trk 2, 3, 5 and 6
	Trk 2, 3, 7 and 8
	Trk 2, 4, 5 and 6
	Trk 2, 4, 7 and 8
<p>All input channels are available. The [INPUT A] channel signal is assigned to the track with the lowest number, the [INPUT B] signal assigned to the track with the next lowest number, the [INPUT C] signal is assigned to the track with the second highest number, and the [INPUT D] signal is assigned to the track with the highest number.</p>	

Recording onto a single track

You can record onto any one of tracks 1 through 4. When making recording to a single track, you can record a signal fed to the [INPUT A] channel.

The following describes the procedure for recording an acoustic guitar onto track 1 via a microphone. We assume that Song02 is loaded and no sound is recorded to Song02. See "Creating a song for recording" on page 31 for details about how to create a song.

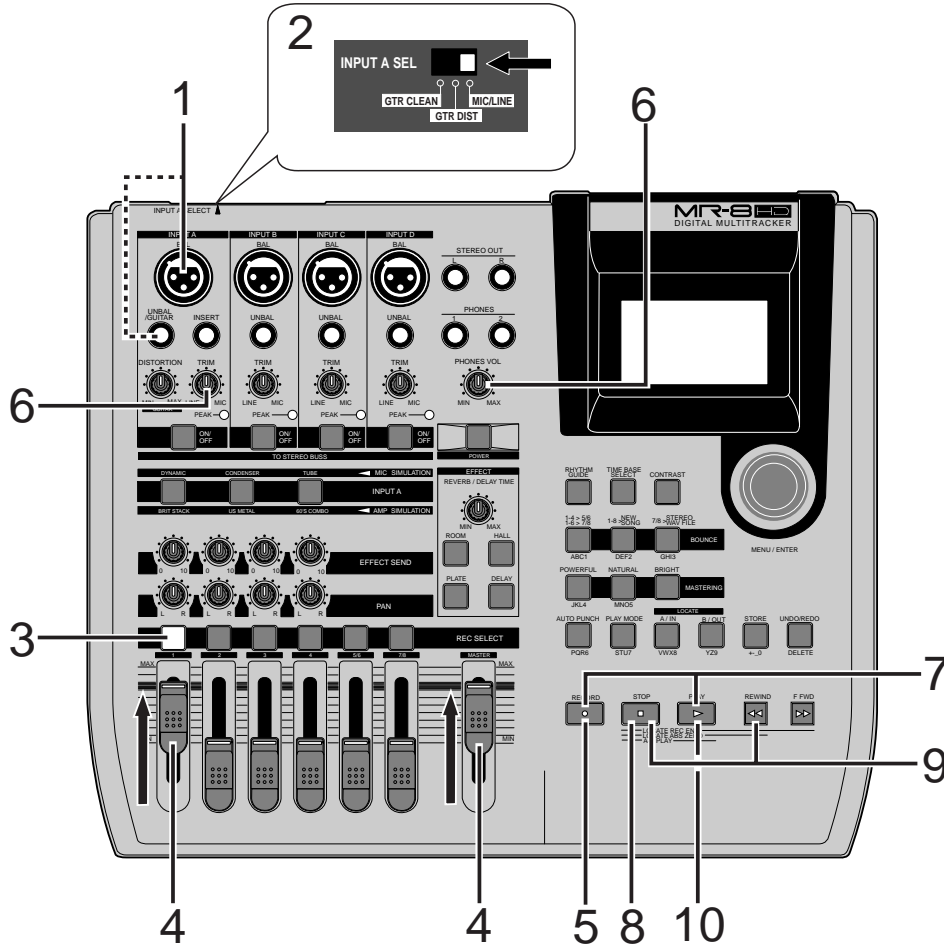

Preparation for recording

- 1) Connect a microphone to the [BAL] or [UNBAL/GUITAR] input connector of the [INPUT A] channel.

<Note>: You can supply the phantom power to a condenser microphone connected to the [BAL] XLR connector (see page 128). Note that you cannot supply the phantom power via the [GUITAR/UNBAL] phone connector.

- 2) Set the [INPUT A SEL] switch to "MIC/LINE".

<Note>: You can apply the mic simulation as insert effects when the [INPUT A SEL] switch to "MIC/LINE" (see page 58).

- 3) Press the [REC SELECT] key for track 1. Track 1 is record armed and the [REC SELECT] key for track 1 starts flashing. On the home screen, the remaining time is shown, while "1" for the track number changes to "A".



- 4) Set track fader 1 and [MASTER] fader to the nominal position (marked by ≡). Raising these faders allows you to monitor the input sound. If these faders are not raised, you cannot monitor the sound via headphones.

<Note>: The fader for track 1 is used to adjust the monitor level. To adjust the recording level, use the [TRIM] control of the [INPUT A] channel.

- 5) Press the [RECORD] key once (the key indicator starts flashing).
Track 1 (which is record armed) now enters the input monitor mode and "INPUT MONI" is shown on the home screen.

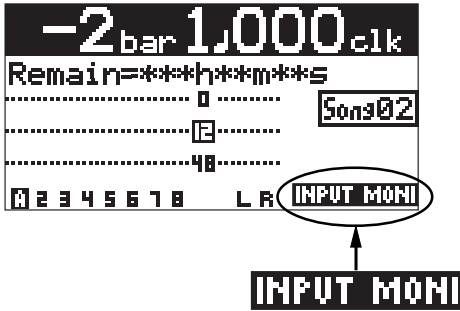

- 6) While playing the guitar, adjust the recording level using the [TRIM] control of the [INPUT A] channel.
Adjust the level appropriately so that the PEAK indicator does not light.
Turning the [PHONES VOL] control clockwise raises the headphone monitor level.

The screen shows the input level of track 1, as well as the stereo L and R output levels.

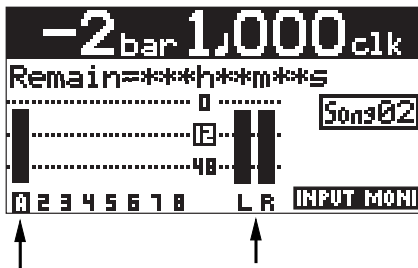

<Note>: Adjust the [TRIM] control properly so that the PEAK indicator does not light at the loudest part of the guitar sound. If the input level is too high, the PEAK indicator lights and the sound may be distorted or noisy.

<Tip>: When receiving a line level signal, set the [TRIM] control to left ("LINE") to get the appropriate level. When receiving a microphone signal, set the [TRIM] control to right ("MIC") to get the appropriate level.

Starting recording

- 7) While holding down the [RECORD] key, press the [PLAY] key to start recording.
The guitar is recorded.
- 8) When recording completes, press the [STOP] key to stop the recorder.

<Note>: We recommend to press the [RESELECT] key for track 1 to unarm track 1.

Playing back the recorded track

- 9) Press the [REWIND] key while holding down the [STOP] key to locate the recorder to the beginning of the song.
- 10) Press the [PLAY] key to start playback.
You can adjust the monitor level using the track 1 fader, as well as the [MASTER] fader and [PHONES VOL] control.

If you are not satisfied with the result, use the undo/redo function to cancel the recording and try again.

Undoing recording (undo/redo)

If you press the [UNDO/REDO] key after finishing recording, you can return to the condition before the recording started (UNDO operation). Therefore, you can try recording again.
If you press the [UNDO/REDO] key again (after UNDO), the undo operation is canceled and you can return to the condition when the recording finished (REDO operation).

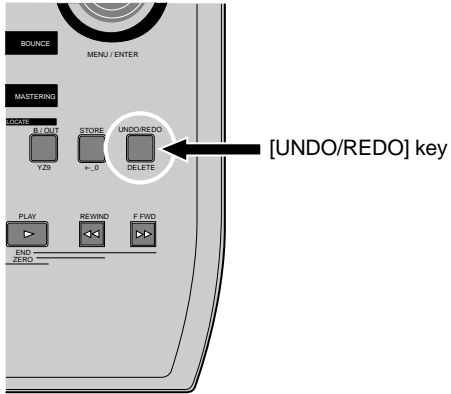

<Notes>: The undo/redo function is available for all kind of recordings, however, if you carry out any of the following operations after making recording, you cannot undo the recording.

- Carrying out new recording.
- Carrying out track or part editing.
- Turning off the power.
- Selecting another song or editing the song name.

Overdubbing basics

Overdubbing is recording something new while listening to the previously recorded track(s). It is a very important method in multitrack recording. The following describes an example of overdubbing for recording a stereo keyboard to tracks 7/8 while listening to the guitar on track 1. See the procedure previously described in "Recording onto a single track" for details about how to record a guitar on track 1. In the procedure below, we assume that the song of which the guitar has been recorded on track 1 is loaded.

Note that you can make overdubbing to another track or other tracks in the same manner as described below.

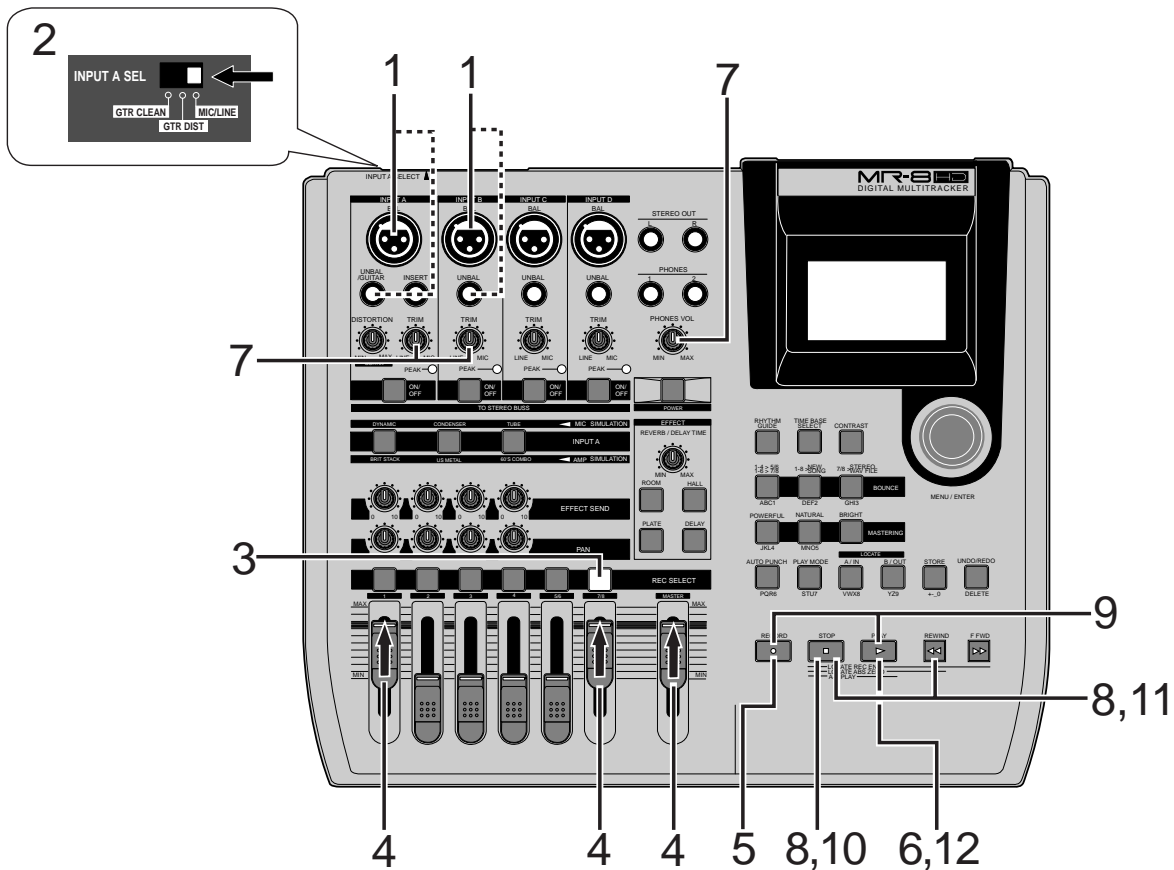

Preparation for recording

- 1) **Connect the L and R outputs of the keyboard to input connectors of the [INPUT A] and [INPUT B] channels.**
Connect the L and R outputs to the [INPUT A] and [INPUT B] channels respectively.
- 2) **Set the [INPUT A SEL] switch to "MIC/LINE".**
- 3) **Press the [REC SELECT] key for tracks 7/8.**
Tracks 7/8 are record armed and the [REC SELECT] key for tracks 7/8 starts flashing.

On the home screen, the remaining time is shown, while "7" and "8" for the track numbers change to "A" and "B" respectively.

This indicates you can now record the [INPUT A] and [INPUT B] channel signals to tracks 7 and 8 respectively.

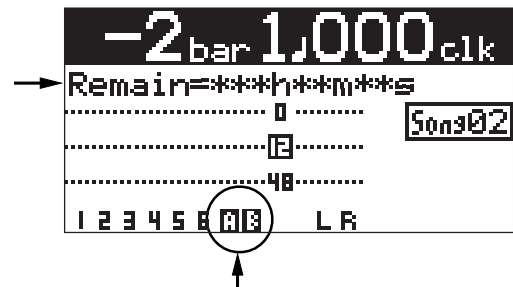

- 4) **Set track faders 1 and 7/8 and the [MASTER] fader to the nominal position (marked by ≡).**
Raising these faders allows you to monitor the input sound. If these faders are not raised, you cannot monitor the sound via headphones.

<Note>: Track 1 and 7/8 faders are used to adjust the monitor level. To adjust the recording levels, use the [TRIM] controls of the [INPUT A] and [INPUT B] channels.

- 5) Press the [RECORD] key once (the key indicator starts flashing).
The armed tracks 7/8 now enter the input monitor mode, while "INPUT MONI" is shown on the home screen.

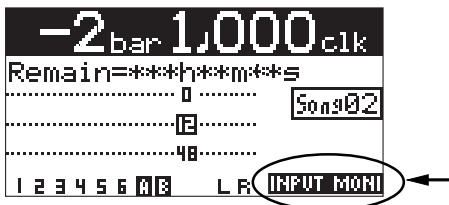

Adjusting the recording levels while listening to track 1

- 6) Press the [PLAY] key to play back the song from the beginning.
Though tracks 7/8 are in the input monitor mode, you can hear the track 1 signal by rotating the [PHONES VOL] control clockwise (while the meter for track 1 shows the playback level).
- 7) While playing the keyboard, adjust the recording levels using the [TRIM] controls of the [INPUT A] and [INPUT B] channels.
Adjust the levels appropriately so that the PEAK indicators for these input channels do not light.
The home screen shows the playback level of track 1 and the input levels of tracks 7 and 8, as well as the stereo L and R output levels.

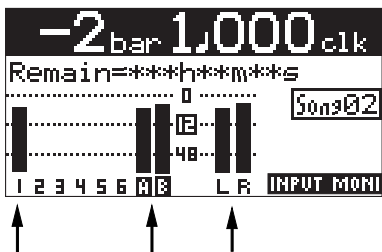

<Note>: Adjust each [TRIM] control properly so that the corresponding PEAK indicator does not light at the loudest part of the keyboard sound.

<Tip>: When receiving a line level signal, set the [TRIM] control to left ("LINE") to get the appropriate level. When receiving a microphone signal, set the [TRIM] control to right ("MIC") to get the appropriate level.

- 8) After adjusting the recording levels properly, press the [REWIND] key while holding down the [STOP] key to locate the recorder to the beginning of the song.

Starting recording

- 9) While holding down the [RECORD] key, press the [PLAY] key to start recording.
The recorder records the keyboard while playing back track 1 (guitar).
- 10) When recording completes, press the [STOP] key to stop the recorder.

<Note>: We recommend to press the [REC SELECT] key for tracks 7/8 to unarm tracks 7/8.

Playing back the recorded track

- 11) Press the [REWIND] key while holding down the [STOP] key to locate the recorder to the beginning of the song.
- 12) Press the [PLAY] key to start playback.
You can adjust the monitor level using the track faders, as well as the [MASTER] fader and [PHONES VOL] control.

<Note>: If you are not satisfied with the result, use the undo/redo function to cancel the recording and try again.

Undoing recording (undo/redo)

If you press the [UNDO/REDO] key after finishing recording, you can return to the condition before the recording started (UNDO operation). Therefore, you can try recording again.
If you press the [UNDO/REDO] key again (after UNDO), the undo operation is canceled and you can return to the condition when the recording finished (REDO operation).

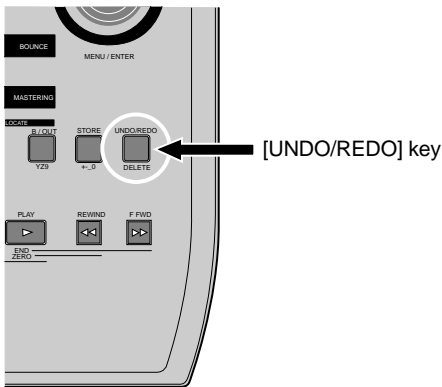

<Notes>: The undo/redo function is available for all kind of recordings, however, if you carry out any of the following operations after making recording, you cannot undo the recording.

- Carrying out new recording.
- Carrying out track or part editing.
- Turning off the power.
- Selecting another song or editing the song name.

Recording onto four tracks simultaneously

You can simultaneously record up to four tracks. See page 34 for the available combinations of four recording tracks. The following describes the procedure for recording different sound sources simultaneously to tracks 1 through 4. You can make four-track simultaneous recording with any available track combination in the same manner.

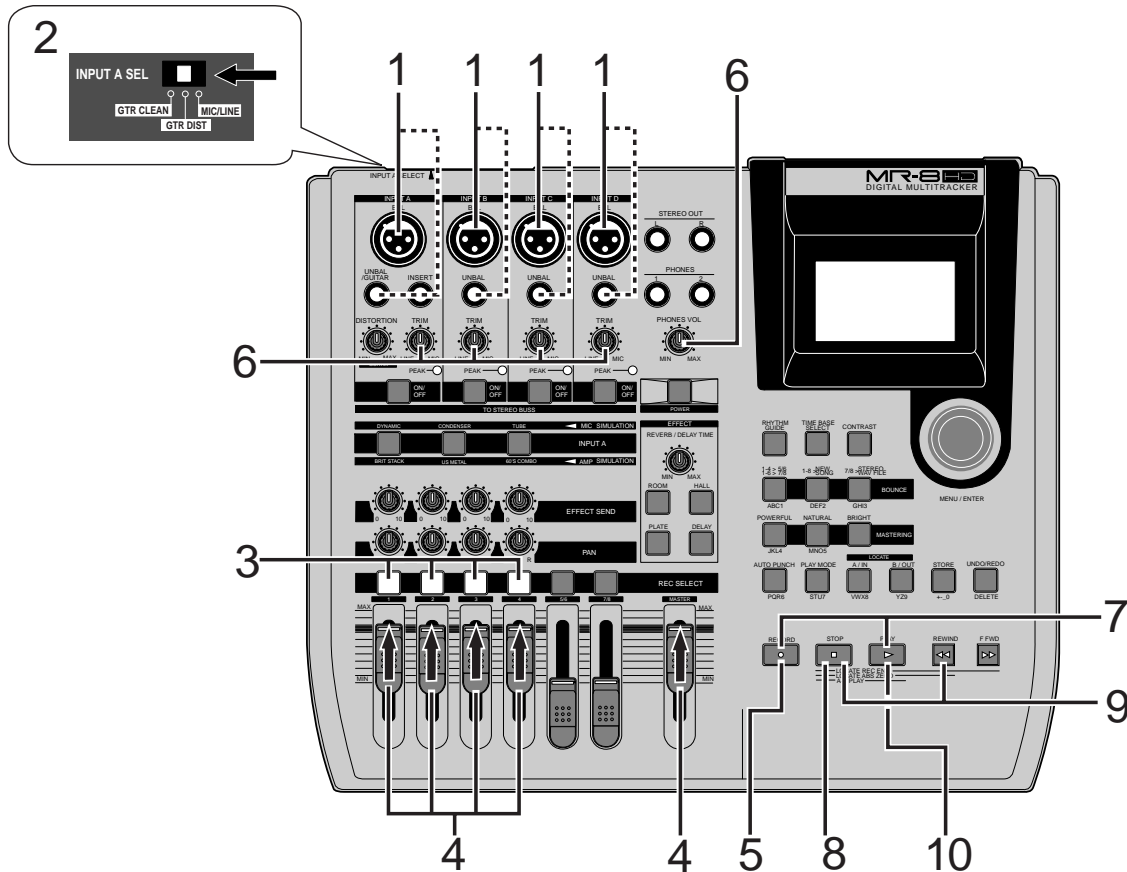

Preparation for recording

- 1) Connect the following sound sources to the [INPUT A] through [INPUT D] channels.

[INPUT A]	->	Electric guitar
[INPUT B]	->	Electric bass
[INPUT C]	->	Microphone (vocal)
[INPUT D]	->	Drum machine

<Note>: If you connect a condenser microphone to the [BAL] XLR connector of the [INPUT C] channel, you can supply the phantom power to the microphone (see page 128).

- 2) Set the [INPUT A SEL] switch to "GUIT DIST". You can add distortion of the internal effects to your guitar sound.

<Note>: You can apply the amp simulation as insert effects when the [INPUT A SEL] switch is set to "GUIT DIST" (see page 58).

- 3) Press the [REC SELECT] key for tracks 1 through 4. Tracks 1 through 4 are record armed and the [REC SELECT] keys for tracks 1 through 4 start flashing.

On the home screen, track numbers "1" through "4" changes to "A" through "D" respectively, showing that each input is assigned to the appropriate track. The remaining time of the hard disk is shown.



- 4) Set the track faders 1 through 4 and [MASTER] fader to the nominal position (marked by ≡). Raising these faders allows you to monitor the input sound. If these faders are not raised, you cannot monitor the sound via headphones.

<Note>: Track faders 1 through 4 are used to adjust the monitor levels. To adjust the recording level, use the [TRIM] controls for [INPUT A] through [INPUT D].

- 5) Press the [RECORD] key once (the key indicator starts flashing).
Tracks 1 through 4 (which are armed) now enter the input monitor mode and "INPUT MONI" is shown on the home screen.

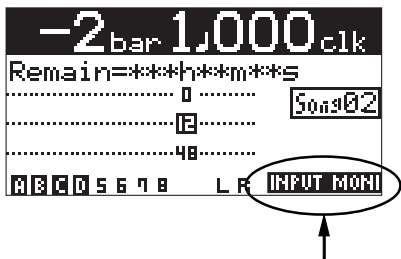

- 6) While playing the music, adjust the recording level of each track using the [TRIM] control of each input channel.
Adjust the level appropriately so that the PEAK indicator does not light.
Turning the [PHONES VOL] control clockwise raises the headphone monitor level.

The screen shows the input level of tracks 1 through 4, as well as the stereo L and R output levels.

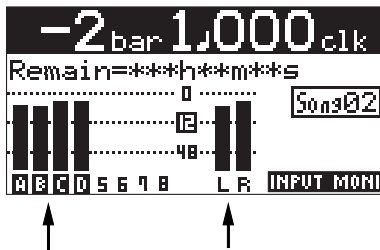

<Note>: Adjust the [TRIM] control of each input channel properly so that the PEAK indicator does not light at the loudest part of the sound.

<Tip>: You can add distortion to an electric guitar connected to [INPUT A]. Use the [DISTORTION] control to adjust the distortion level. When you add distortion, readjust the [TRIM] control.

<Tip>: When receiving a line level signal, set the [TRIM] control to left ("LINE") to get the appropriate level. When receiving a microphone signal, set the [TRIM] control to right ("MIC") to get the appropriate level.

Starting recording

- 7) While holding down the [RECORD] key, press the [PLAY] key to start recording.
The recorder starts recording.
- 8) When recording completes, press the [STOP] key to stop the recorder.

<Note>: We recommend to press the [REC SELECT] key for tracks 1 through 4 to un-arm these tracks.

Playing back the recorded track

- 9) Press the [REWIND] key while holding down the [STOP] key to locate the recorder to the beginning of the song.
- 10) Press the [PLAY] key to start playback.
You can adjust the monitor level using track faders 1 through 4, as well as the [MASTER] fader and [PHONES VOL] control.

<Tip>: If you are not satisfied with the result, use the undo/redo function to cancel the recording and try again.

Undoing recording (undo/redo)

If you press the [UNDO/REDO] key after finishing recording, you can return to the condition before the recording started (UNDO operation). Therefore, you can try recording again.
If you press the [UNDO/REDO] key again (after UNDO), the undo operation is canceled and you can return to the condition when the recording finished (REDO operation).

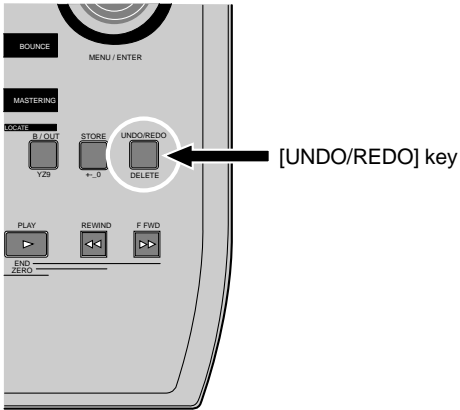

<Notes>: The undo/redo function is available for all kind of recordings, however, if you carry out any of the following operations after making recording, you cannot undo the recording.

- Carrying out new recording.
- Carrying out track or part editing.
- Turning off the power.
- Selecting another song or editing the song name.

Basic mixdown

This section describes basic mixdown which is the final process of multitrack recording. Mixdown mixes recorded materials on tracks 1 through 8 down to stereo. The mixdowned material can be recorded to an external master recorder.

The MR-8HD is equipped with the [DIGITAL OUT] connector, so you can record a mixdowned signal to a digital master recorder (DAT, MD, etc.) which can accept an S/P DIF digital signal in digital domain. With the MR-8HD, you can also record a mixdowned signal internally to a new song of the MR-8HD using the track bouncing function, without the need of an external master recorder (see "Track bouncing" described later).

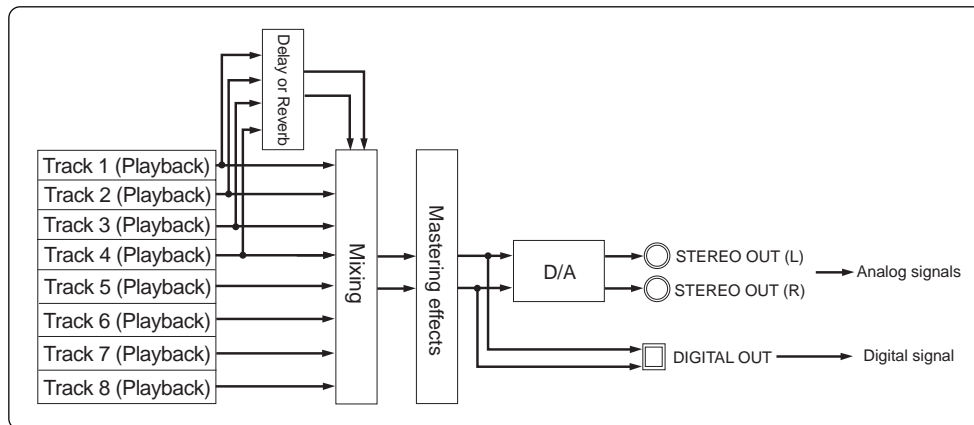

Mixdown to an analog recorder

The following describes how to make mixdown recording to an external analog recorder.

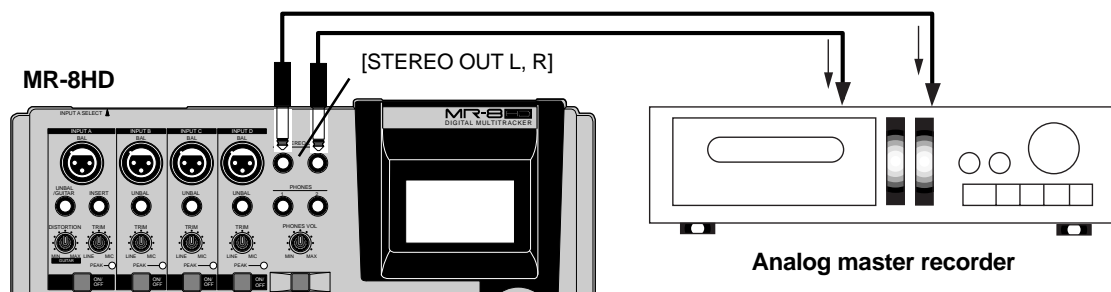

- 1) Connect the [STEREO OUT (L, R)] connectors of the MR-8HD to the input connectors of an analog master recorder.
- 2) While playing back the MR-8HD, rehearse mixing down the recorded sounds by adjusting the level and panning of each track, applying effects to tracks 1 through 4 and applying the mastering effects to the L/R stereo mix, etc.
The output levels from the [STEREO OUT (L, R)] connectors can be controlled by the [MASTER] fader.
Adjust the levels appropriately so that the highest segments of L and R meters do not light.
- 3) Adjust the recording level of the master recorder while rehearsing mixdown.
See the manual of the master recorder for details about how to adjust the recording level.
- 4) After rehearsing mixdown and adjusting the recording level, locate the MR-8HD to the beginning of the song.
- 5) Start the master recorder recording and then start the MR-8HD playing back.
- 6) After finishing recording, stop both recorders.

See "Using effects" on page 57 for details about the delay/reverb and mastering effects.
You can also mix sound sources connected to [INPUT A] through [INPUT D] during mixdown.
See page 73 for details.

<Tip>: By sliding up or down the MR-8HD [MASTER] fader gradually, you can fade in or fade out recording.

Mixdown to a digital recorder

The following describes how to make mixdown recording to an external digital recorder.

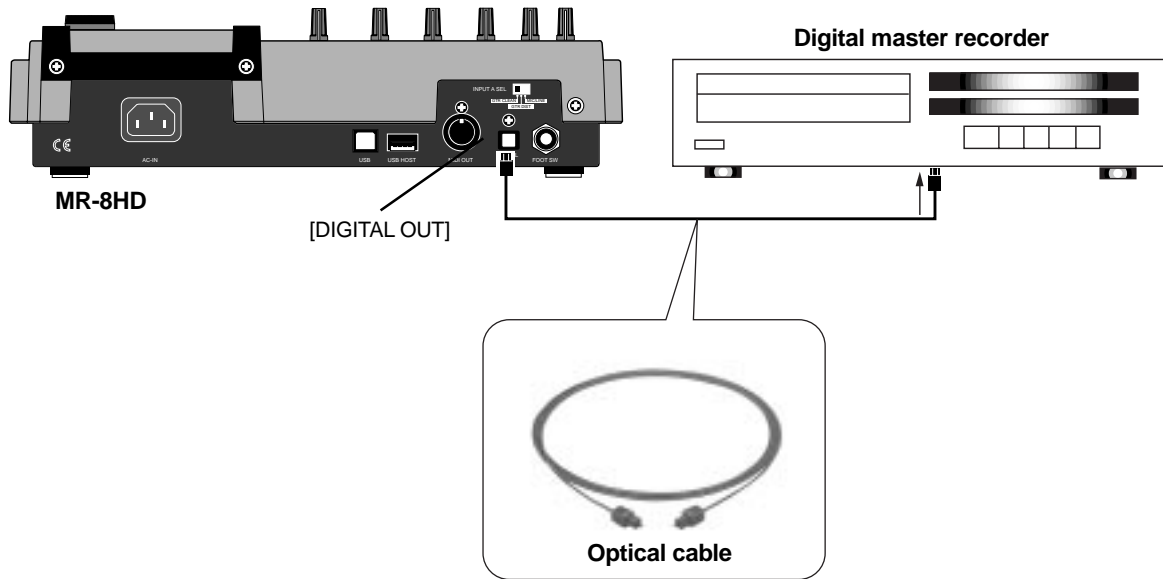

- 1) **Connect the [DIGITAL OUT] connector of the MR-8HD to the digital input connector of a digital master recorder using an optical cable.**

<Note>: The [DIGITAL OUT] connector of the MR-8HD is the Toslink optical type. If your digital recorder provides only the coaxial type connector, use the Fostex COP-1/96 kHz coaxial-optical converter. Contact Fostex or our dealer for details about the Model COP-1/96 kHz.

Model COP-1/96kHz

- 2) **Set the master recorder to accept the digital input.**
 Make sure that the recorder accepts the digital signal output from the MR-8HD, which is 44.1-kHz, 16-bit, S/P DIF signal. Generally, a digital recorder cannot adjust the digital input level.

- 3) **While playing back the MR-8HD, rehearse mixing down the recorded sounds by adjusting the level and panning of each track, applying effects to tracks 1 through 4 and applying the mastering effects to the L/R stereo mix, etc.**

See "Using effects" on page 57 for details about the delay/reverb and mastering effects. You can also mix sound sources connected to [INPUT A] through [INPUT D] during mixdown. See page 72 for details.

- 4) **Use the [MASTER] fader of the MR-8HD to adjust the output level.**

Adjust the level appropriately so that the level meter of the master recorder shows "0" when the MR-8HD outputs the biggest signal. If the level meter exceeds "0", the sound may be distorted.

- 5) **Start the master recorder recording and then start the MR-8HD playing back.**

<Tip>: By sliding up or down the MR-8HD [MASTER] fader gradually, you can fade in or fade out recording.

- 6) **After finishing recording, stop both recorders.**

Advanced playback and locate functions

This chapter describes advanced playback functions including cueing, partial playback (between points A and B), special play modes, as well as the locate function.

3 x cueing

By holding down the [F FWD] or [REWIND] key during playback, the recorder enters cueing mode and you can monitor playback at 3 x speed. It may be useful for searching a specific position.

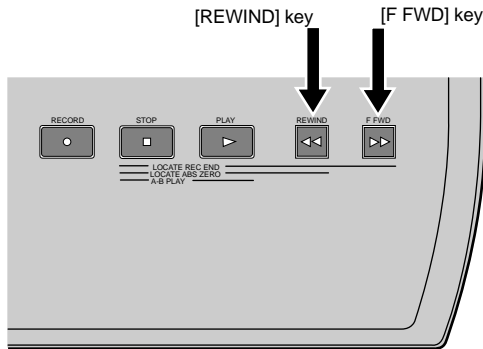

- **By holding down the [F FWD] key during playback, the recorder starts cueing forwards at 3 x speed.** During forward cueing, ">>" is shown on the display.



- **By holding down the [REWIND] key during playback, the recorder starts cueing backwards at 3 x speed.** During backward cueing, "<<" is shown on the display.



Playback between LOCATE A and B points

When the LOCATE A and LOCATE B points are set, you can playback between these points once. This function is always available regardless of the play mode setting (see "Play mode" on next page). This function allows you to check the editing part (between LOCATE A and B points) for copy/paste, erase, etc. See "Part editing" described later.

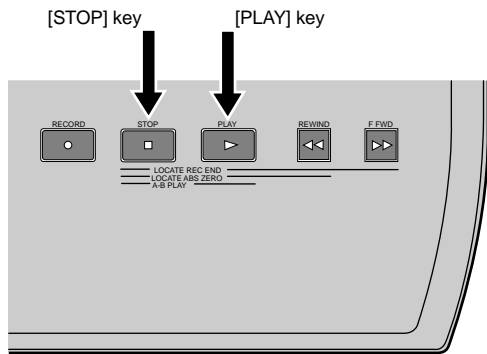

- **While the recorder is stopped, press the [PLAY] key while holding down the [STOP] key.** The MR-8HD plays back audio data between the LOCATE A and LOCATE B points once, then stops.

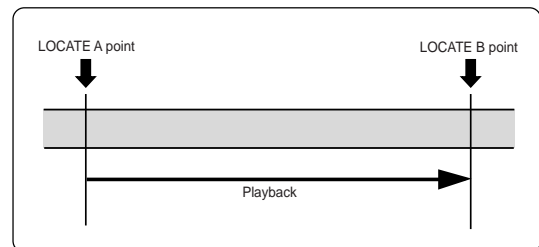

<Note>: Note that this function is available only when the LOCATE A and B points are set. See page 49 for details about how to set the LOCATE A and B points.

<Note>: If you carry out the operation above when the LOCATE A point is set ahead of the LOCATE B point (i.e. LOCATE A > LOCATE B), the MR-8HD plays back audio data from the LOCATE A point to the REC END points once, then stops.

While the recorder is playing back between the LOCATE A and B points, the display shows the icon as below.



During playback, you can monitor playback audio of the desired track(s) by raising the appropriate track fader(s), the [MASTER] fader and the [PHONES] control.

Play mode

The MR-8HD offers special play modes including the auto play, auto return and loop playback modes in addition to the normal playback mode.

Selecting a play mode

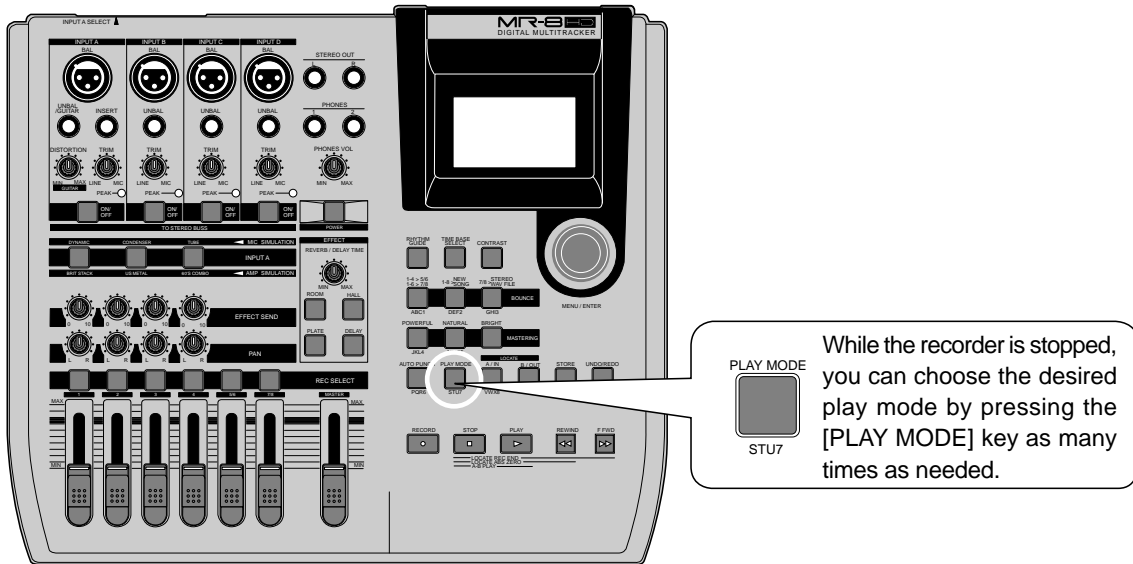

While the recorder is stopped, each time you press the [PLAY MODE] key, the play mode switches among "Off", "Auto Play", "Auto return" and "Loop". The current mode is shown on the screen as follows (when "Off" is selected, there is no indication).

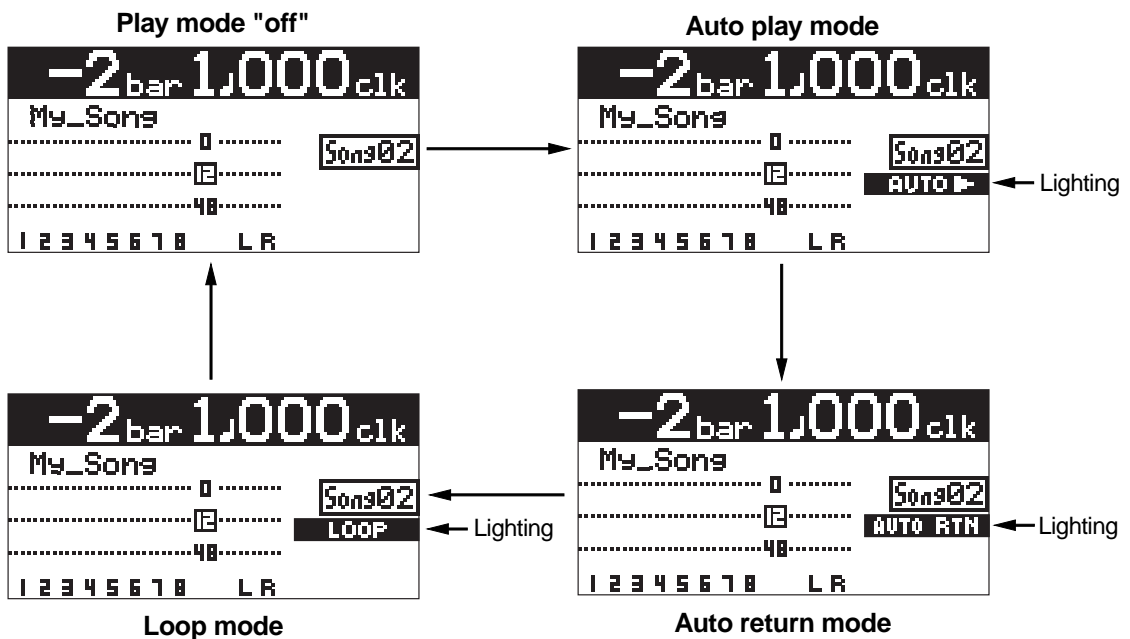

Auto play mode

In the Auto play mode, when locating to the ABS ZERO, REC END, LOCATE A or LOCATE B point, the recorder automatically starts playback from the point. The following shows the auto play function after locating to the LOCATE A point (see page 48 for the locate function).

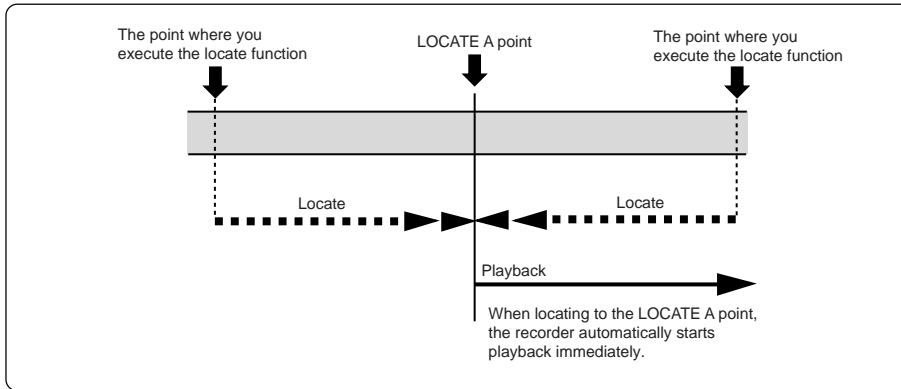

Auto return mode

The auto return mode is active when the LOCATE A and LOCATE B points are set. In the auto return mode, when reaching at the LOCATE B point during playback, the recorder automatically locates to the LOCATE A point and stops.

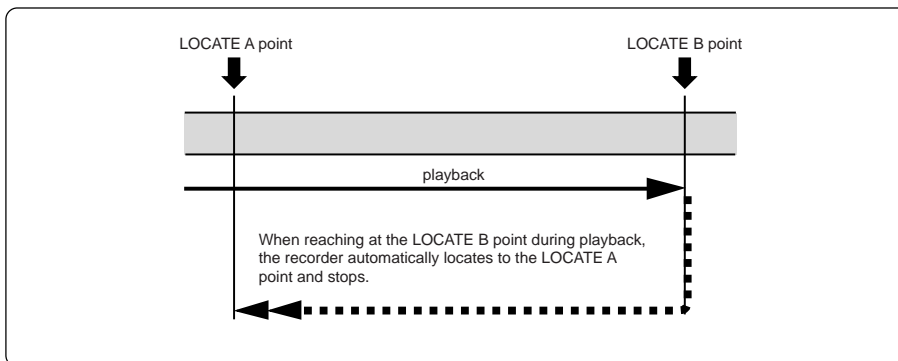

Loop mode

As with the auto return mode, the loop mode is active when the LOCATE A and LOCATE B points are set. In the loop mode, when reaching at the LOCATE B point during playback, the recorder automatically locates to the LOCATE A point and starts playback. The recorder repeats this behavior until you stop the recorder.

You may find it very convenience to use the loop function together with the auto punch in/out function (see the next page).

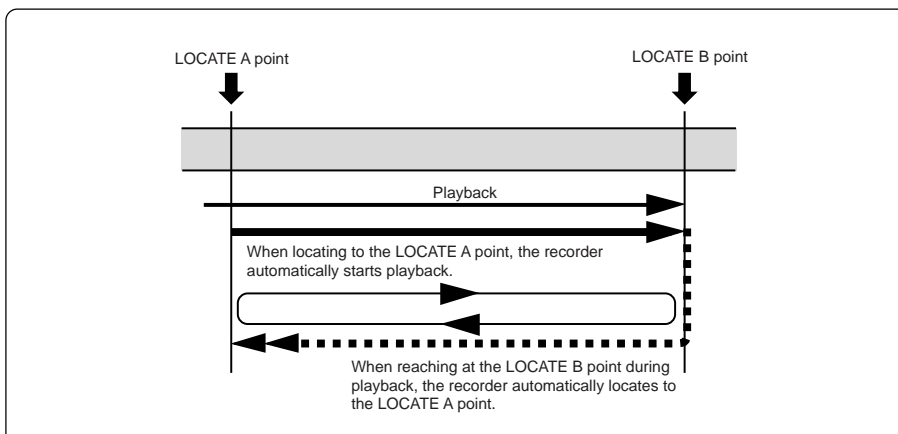

Loop function in auto punch in/out mode

When the loop mode is active (while the auto punch in/out mode is inactive), the LOCATE A and LOCATE B points are used as the loop start and end points. When the auto punch in/out mode is active (while the loop mode is inactive), the LOCATE A and LOCATE B points are used as the punch-in and punch-out points.

When both the auto punch in/out and loop modes are active, the LOCATE A and LOCATE B points are used as the punch-in and punch-out points, while the loop function starts at "the LOCATE A point minus the pre-roll time" and ends at "the LOCATE B point plus the post-roll time, as shown below. The pre-roll time is initially set to four seconds, while the post-roll time is set to one second.

<Note>: If you set the LOCATE A point to the beginning of a song (ABS ZERO) or set the LOCATE B point to the recording end point (REC END) of a song, the pre-roll or post-roll time is ignored.

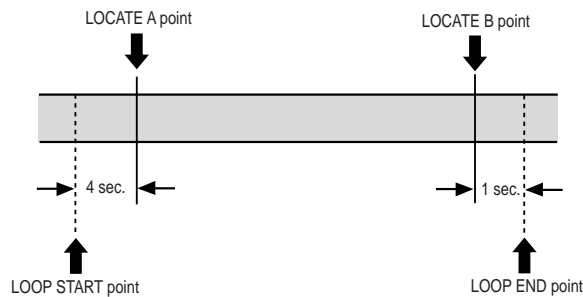

Using the loop function in the auto punch in/out mode reduces the number of key presses, allowing you to concentrate on playing.

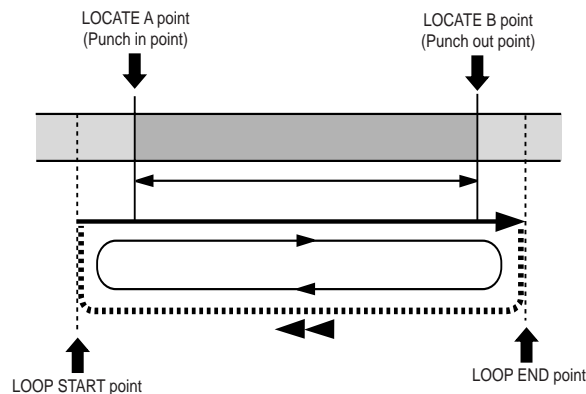

You can change the pre-roll and post-roll time within the range between 0.1 and 10.0 seconds (in 0.1 second steps) in the menu mode (see page 126).

Locate function

The following describes the locate functions, which allow you to immediately skip to a specified point in a song.

Time locate

Regardless of the current recorder position, you can locate to the beginning (ABS ZERO) of the song or the recording end (REC END) of the song.

Locating to the beginning (ABS ZERO) of a song

- While the recorder is stopped, press the [REWIND] key while holding down the [STOP] key.

The MR-8HD immediately locates to the beginning of the song (ABS ZERO) and stops.

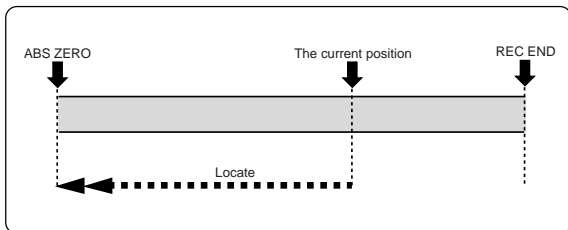

[STOP] key + [REWIND] key

Locating to the recording end point (REC END) of a song

- While the recorder is stopped, press the [F FWD] key while holding down the [STOP] key.

The MR-8HD immediately locates to the recording end of the song (REC END) and stops.

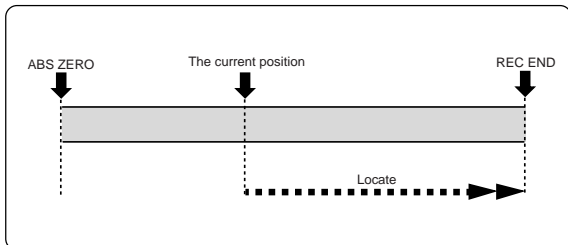

[STOP] key + [F FWD] key

Locating to the LOCATE A or LOCATE B point

You can set the desired point of a song as the LOCATE A or LOCATE B point. The LOCATE A and B points can be used not only for locating, but also for auto punch in/out, play modes and part editing, etc.

Setting the LOCATE A or LOCATE B point

You can set the LOCATE A or LOCATE B point while the recorder is running or stops at the desired point, regardless of time base setting.

<Note>: You cannot set the LOCATE A or B point for a protected song. If you are going to do so, the warning message ("This song is protected!") is shown. To set the LOCATE A or B point for a protected song, release the protection first (see page 101).

<Note>: The LOCATE A point must be earlier than the LOCATE B point. If not, you cannot carry out the auto punch in/out or loop function correctly.

<Tip>: While the time base is set to the bar/beat mode, if you set the "Beat resolution" menu item in the menu mode to "On", you can store the LOCATE A or B point in beat resolution. In other words, the clock digit of the Bar/Beat/Clk value is automatically rounded down or up, so that the clock digit is always "000". See page 127 for details about how to make the beat resolution active or inactive.

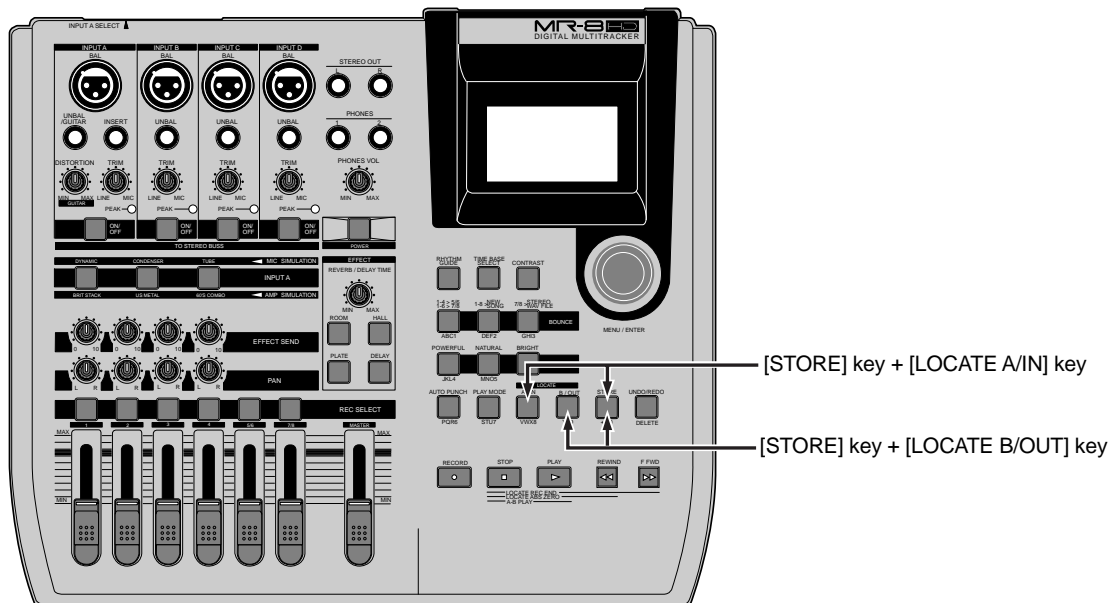

- To set the LOCATE A point:**
 When the recorder is playing back (or stopped), press the [LOCATE A/IN] key at the desired point while holding down the [STORE] key. The display briefly shows "Store LOCATE A", and the point when pressing the [LOCATE A/IN] key is stored as the LOCATE A point.
- To set the LOCATE B point:**
 When the recorder is playing back (or stopped), press the [LOCATE B/OUT] key at the desired point while holding down the [STORE] key. The display briefly shows "Store LOCATE B", and the point when pressing the [LOCATE B/OUT] key is stored as the LOCATE B point.

Locating

While the recorder is stopped, press the [LOCATE A/IN] (or [LOCATE B/OUT]) key.
The recorder instantly locates to the appropriate point.

- When the current recorder position is between the LOCATE A and LOCATE B points:

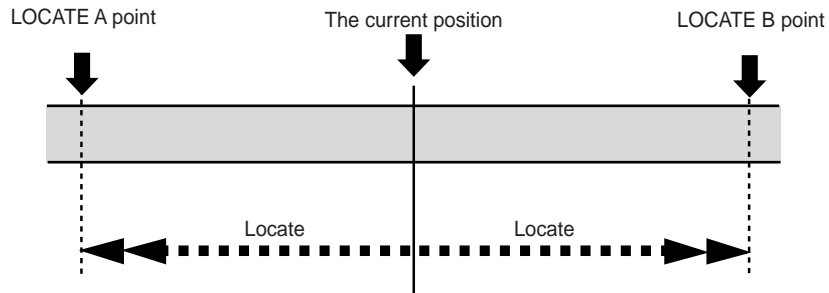

- When the current recorder position is before the LOCATE A and LOCATE B points:

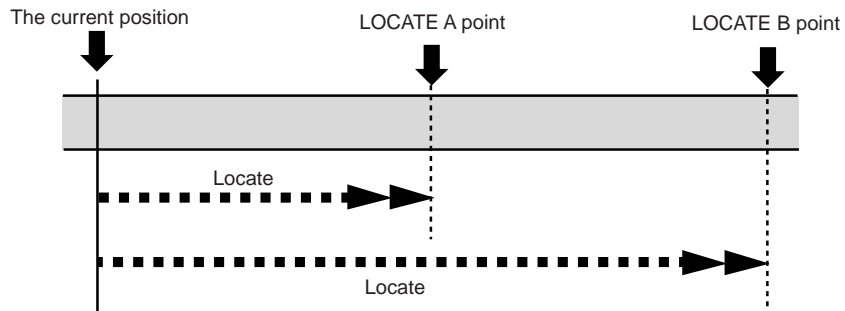

- When the current recorder position is after the LOCATE A and LOCATE B points:

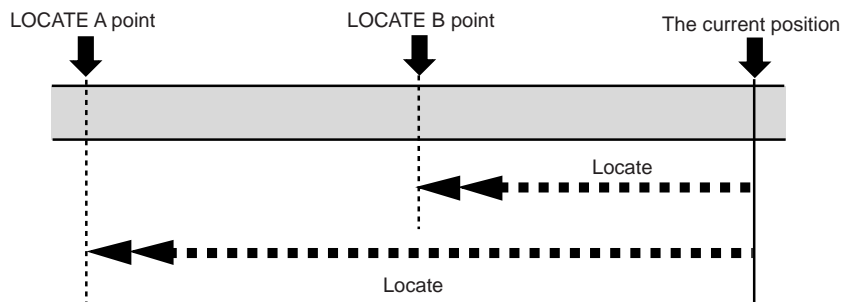

<Tip>: By selecting the play mode to "Auto play", the recorder automatically starts playback after locating the LOCATE A or LOCATE B point.

Punch in/out

Using the punch in/out function of the MR-8HD, you can overwrite the desired part of the recorded track. "Punch in" means switching from playback to recording, while "punch out" means switching from recording to playback. The MR-8HD offers three methods for making punch in/out recording.

- 1) **Manual punch in/out using the top panel keys**
- 2) **Punch in/out using a footswitch**
- 3) **Auto punch in/out at the specified in/out points**

The following description assumes that the song you are going to make punch in/out recording to is loaded and the preparations for recording is completed.

Punch in/out using the keys on the top panel

You can make punch in/out manually by using the [RECORD] and [PLAY] keys on the MR-8HD top panel.

<Note>: The punch in/out operation by yourself using the keys on the top panel sometimes prevents you from concentrating on playing. In such a case, ask someone to operate the MR-8HD, or use either of the other two punch in/out methods described later.

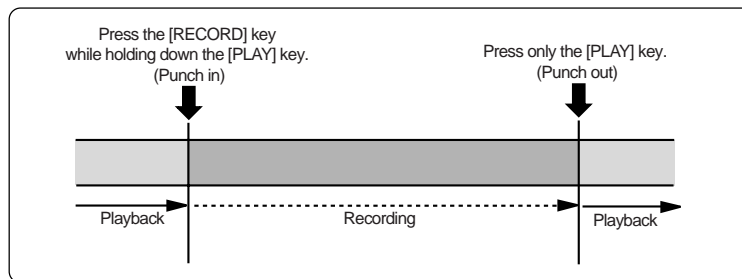
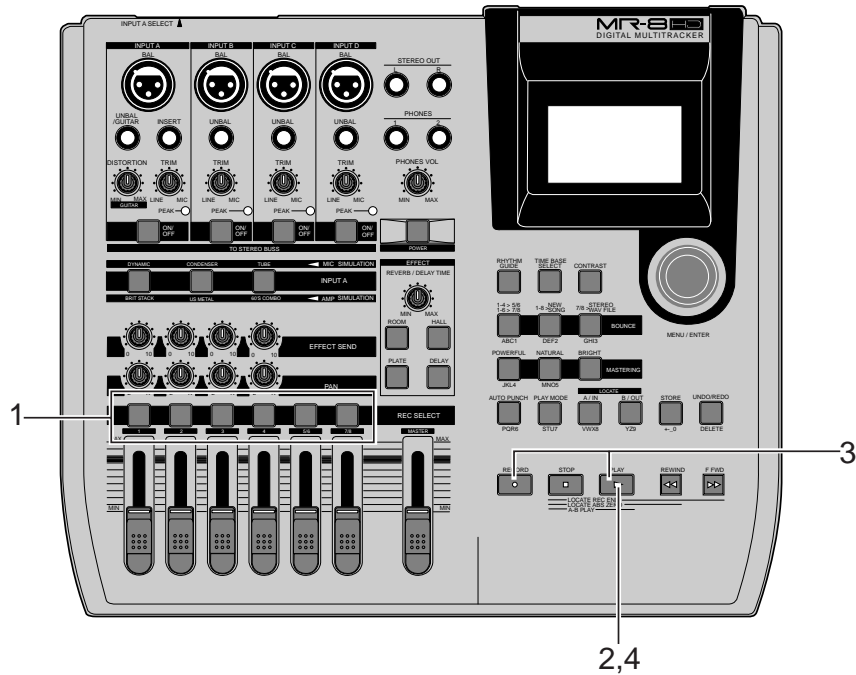

- 1) **Press the [REC SELECT] key for the track you are going to make punch in/out recording.** The track is record-armed.
- 2) **Locate the recorder to the point before the punch-in point and press the [PLAY] key to start playback.** It may be a good idea to play the instrument along with the playback sound, so that you can get the tempo and feel.
- 3) **When the recorder reaches at the point you want to punch in, press the [RECORD] key while holding down the [PLAY] key (see <Important note> below).** The armed track is punched in (i.e. starts recording).

<Important note>

You cannot punch in by only pressing the [RECORD] key. You need to hold down the [PLAY] key when pressing the [RECORD] key.

- 4) **When the recorder reaches at the point you want to punch out, press only the [PLAY] key.** The recorder status switches from recording to playback.
- 5) **Press the [STOP] key to stop the recorder.**
- 6) **Rewind the recorder and play back the part you performed the punch in/out recording to check the result.**

If you are not satisfied with the result, use the undo function to cancel the punch in/out recording and try again.

Punch in/out using the footswitch

You can make hands-free punch in/out recording using an unlatched-type footswitch.

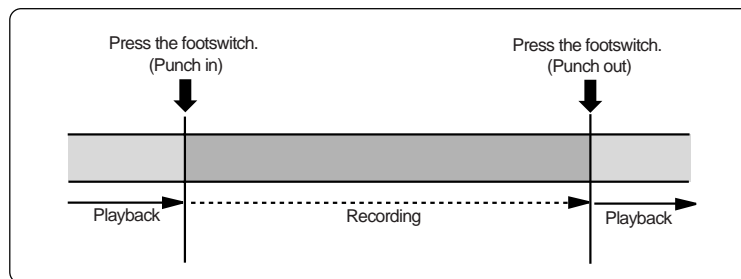
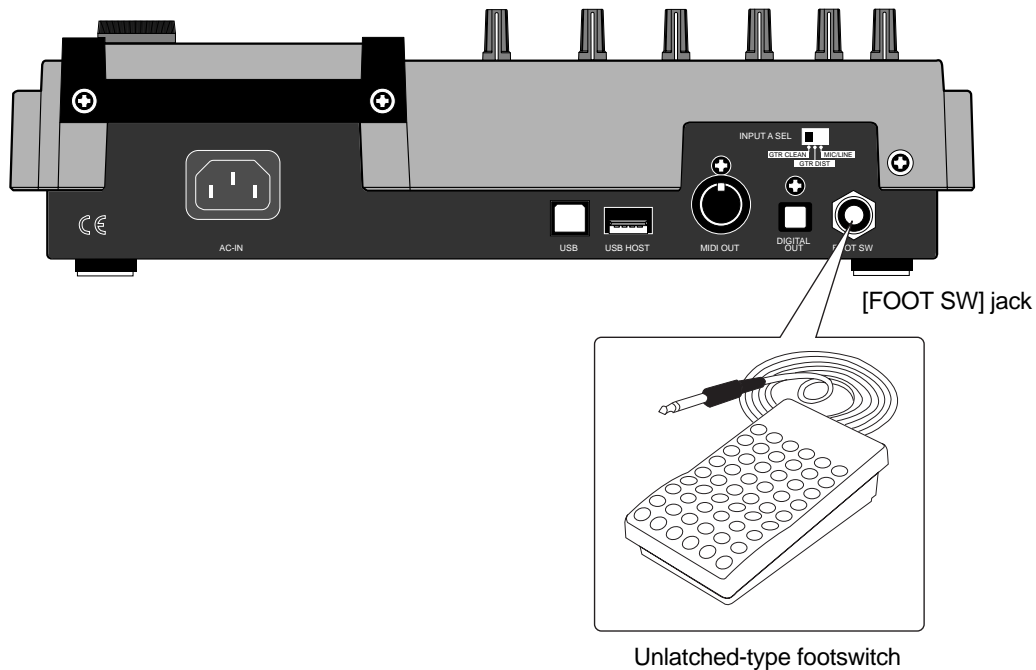

- 1) **Connect the footswitch to the [FOOT SW] jack on the MR-8HD rear panel.**
- 2) **Press the [REC SELECT] key for the track you are going to make punch in/out recording.**
The track is record-armed.
- 3) **Locate the recorder to the point before the punch-in point, and press the [PLAY] key to start playback.**
It may be a good idea to play the instrument along with the playback sound, so that you can get the tempo and feel.
- 4) **When the recorder reaches at the point you want to punch in, press the footswitch.**
The armed track is punched in (i.e. starts recording).
- 5) **When the recorder reaches at the point you want to punch out, press the footswitch again.**
The recorder status switches from recording to playback.

<Note>: You cannot perform another punch in/out recording successively.
To perform punch in/out recording in another part, stop the recorder and perform the steps above again.

- 6) **Press the [STOP] key to stop the recorder.**
- 7) **Rewind the recorder and play back the part you performed the punch in/out recording to check the result.**
If you are not satisfied with the result, use the undo function to cancel the punch in/out recording and try again.

Auto punch in/out

By setting the punch-in and punch-out points in advance, The recorder automatically makes punch in/out recording for you. You can rehearse punch in/out recording as many times you like.

Setting the punch-in and punch-out points

You can set the punch-in and punch-out points on-the-fly while playing back the recorder (as well as you can set them while the recorder is stopped at the desired position).

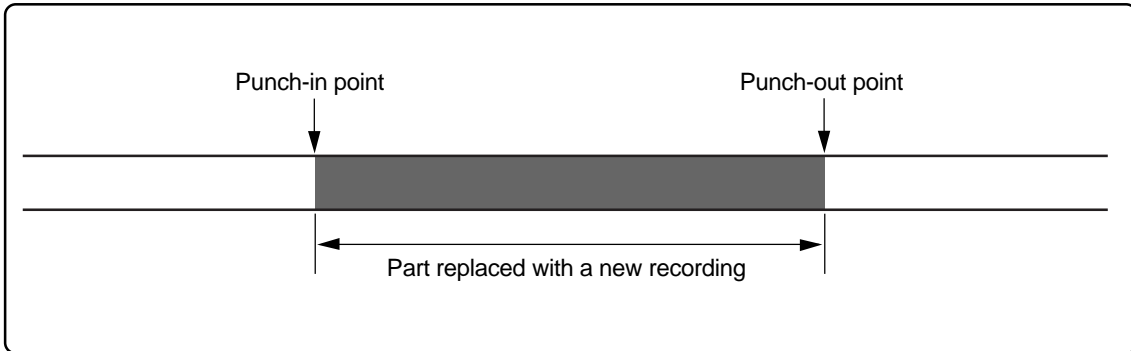

<Note>: You cannot make punch-in/out recording on a song which is protected. Release the song protection before making punch-in/out recording.

<Note>: If you are not satisfied with the punch-in or punch-out point you set, simply redo the operation above. The new time data overwrites the previous one.

- 1) **Start playback from the beginning of the song (or from a point before the point where you want to make punching in) by pressing the [PLAY] key.**
- 2) **When the recorder reaches at the point where you want to make punching in, press the [LOCATE A/IN] key while holding down the [STORE] key.**
The display briefly shows "Store LOCATE A" and the time data when you press the [LOCATE A/IN] key is set as the punch-in point.

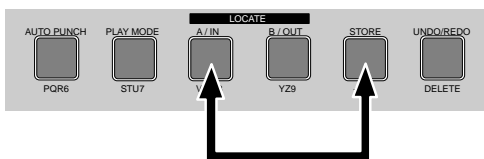

- 3) **When the recorder reaches at the point where you want to make punching out, press the [LOCATE B/OUT] key while holding down the [STORE] key.**
The display briefly shows "Store LOCATE B" and the time data when you press the [LOCATE B/OUT] key is set as the punch-out point.

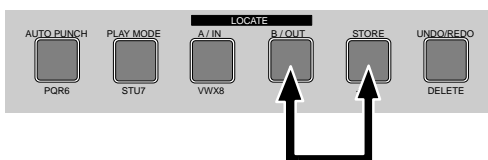

- 4) **Stop the recorder after setting the punch-in and punch-out points, and rewind the recorder to the beginning of the song (or to a point before the point where you want to make punching in).**

<Hint>: To rewind the recorder to the beginning of the song after setting the punch-out point, press the [REWIND] key while holding down the [STOP] key.

To locate before the punch-in point, carry out the following.

- (1) **While the recorder is stopped, press the [LOCATE A/IN] key.**
The recorder immediately locates to the punch-in point and stops.
- (2) **Press the [REWIND] key to move back the recorder and press the [STOP] key at the desired point.**

<Hint>: The punch-in and punch-out points you set also can be used for the locate function, playback by the play mode and part editing (see pages 45 and 111).

Rehearsal for auto punch in/out

After setting the punch-in and punch-out points appropriately, you can rehearse the auto punch in/out for checking the punch-in and -out points or practicing punch-in and -out timing.



<How to make auto punch in/out mode active>

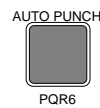

Pressing the [AUTO PUNCH] key switches the auto punch in/out mode on or off. Each press of the [AUTO PUNCH] key turns on or off the indicator.

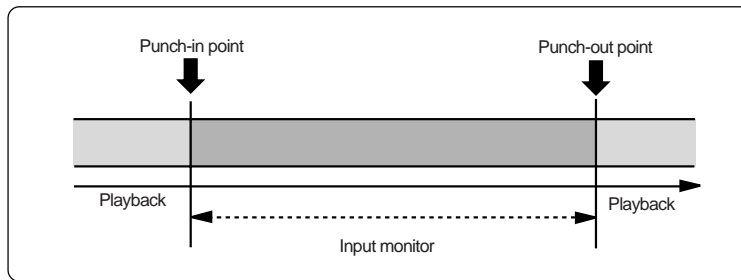

- 1) Locate the recorder to the point before the punch-in point (or the beginning of the song).

<Tip>: You can immediately locate to the punch-in point by pressing the [LOCATE A/IN] key. Therefore, by pressing the [LOCATE A/IN] key, followed by the [REWIND] key then the [STOP] key, you can easily locate to the point before the punch-in point.

- 2) Press the [REC SELECT] key of the track you are going to make punch in/out operation to arm the track.
- 3) Press the [AUTO PUNCH] key to make the auto punch mode active.

The "AUTO PUNCH" icon is now shown on the screen.



- 4) Press the [PLAY] key. The recorder starts punch in/out rehearsal. The "AUTO PUNCH" icon on the display changes to the "REHEARSAL" icon.

In the rehearsal mode, the recorder automatically switches the monitor of the armed track from "repro" to "input" at the punch-in point, but actual recording is not made (the [RECORD] key flashes while "INPUT MONI" is shown on the display).

By repeating the operation above, you can practice auto in/out operation as many times as you like.

- 5) After the punch-out point is passed, locate the recorder back to the beginning position.

<Note>: By using the loop function when rehearsing the auto punch in/out operation, you can concentrate on playing without the need of troublesome operation of the MR-8HD. See page 45 for details about the loop function.

Actual auto punch in/out

After rehearsing the auto punch-in/out operation, it's time for executing actual auto punch in/out operation.

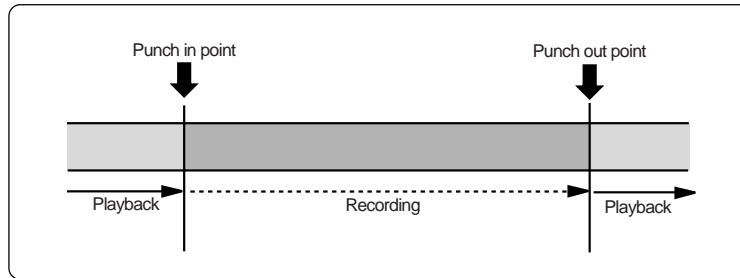

- 1) **Locate the recorder to the point before the punch-in point.**
- 2) **Make sure that "AUTO PUNCH" is shown on the screen (i.e. the auto punch mode is active).**
If it is not shown, press the [AUTO PUNCH] key.
- 3) **Press the [RECORD] key while holding down the [PLAY] key.**
The recorder starts executing actual punch in/out operation. The "AUTO PUNCH" icon on the display changes to the "TAKE" icon.

Unlike the rehearsal, the recorder automatically starts recording when it reaches the punch-in point, then automatically stops recording and exits the auto punch mode at the punch-out point.

<Note>: You can cancel the auto punch in/out recording you made by pressing the [UNDO/REDO] key.

<Note>: In addition to the punch in/out function, the MR-8HD allows you to edit the recorded material using the following editing functions.

- Deleting the whole data on the desired track (using the "Erase Track" menu item). See page 104.
- Copying all data on a track and pasting it to another track (using the "Copy Paste Track" menu item). See page 105.
- Moving the desired track data to the other track(s) (using the "Move Track" menu item). See page 107.
- Exchanging all track data between tracks (using the "Change Track" menu item). See page 108.
- Deleting the desired part (using the "Erase Part" menu item). See page 113.
- Pasting the desired part(s) to the other track(s) (using the "Copy Paste Part" menu item or the "Copy Part" and "Paste Part" menu items). See pages 114 and 116.
- Moving the desired part(s) to the other track(s) (using the "Move Part" menu item). See page 119.
- Exchanging parts between tracks (using the "Change Part" menu item). See page 121.

<About "part">

A "part" is defined as audio data between the "LOCATE A" and "LOCATE B" points. Therefore, you have to set the "LOCATE A" and "LOCATE B" points when editing a "part".

The punch-in and punch-out points set for the auto punch in/out function also can be used as the "LOCATE A" and "LOCATE B" points.

Using effects

The MR-8HD provides the insert effects for recording (microphone and amplifier simulation effects), the delay/reverb effects for track bounce or mixdown (for tracks 1 through 4 only), and the mastering effects for L/R mix. You can also use an external effect device connected to the [INSERT] connector.

Using the insert effects

The [INPUT A] channel of the MR-8HD provides two types of insert effects: microphone and amplifier simulation effects. These effects can be used during recording.

These effects simulate popular microphones and guitar amplifiers. If you use the microphone simulation effect when you record an acoustic guitar through your microphone, you can make recording as if you are using a famous microphone. If you use the guitar amplifier simulation effect when you record an electric guitar directly connected to the MR-8HD, you can make recording as if you are using a famous guitar amplifier.

Note that you cannot get exactly the same sound as the original microphone/guitar amplifier by using simulation effects.

Mic simulation effects

You can use mic simulation effects when the [INPUT A SELECT] switch on the rear panel is set to "MIC/LINE".

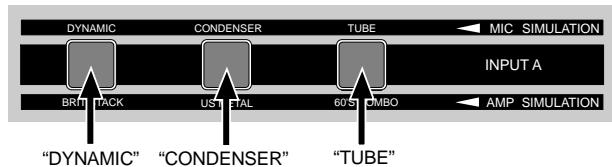
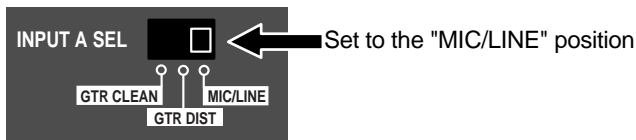

By pressing the appropriate key, you can choose from among three mic simulation effects: DYNAMIC, CONDENSER and TUBE (the indicator of the key lights up).

• Details of each mic simulation effect

DYNAMIC	Simulates the sound of a popular dynamic microphone.
CONDENSER	Simulates the sound of a popular condenser microphone for professional use.
TUBE	Simulates the sound of a popular tube microphone for professional use.

Amp simulation effects

You can use mic simulation effects when the [INPUT A SEL] switch on the rear panel is set to "GTR DIST" or "GTR CLEAN". Only when the switch is set to "GTR DIST", you can also use the distortion (adjusted by the [DISTORTION] control), as well as the insert effects.

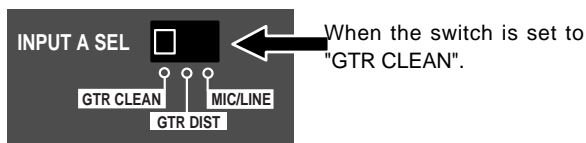
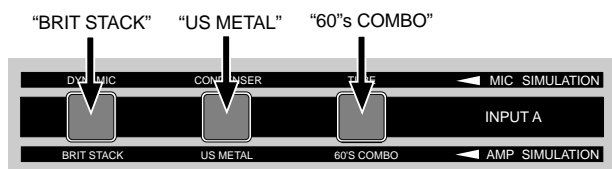
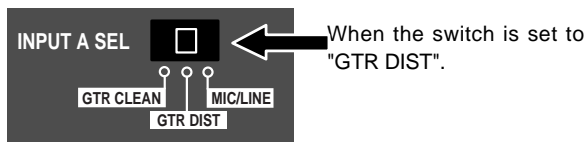

• Amp simulation effects details

BRIT STACK	Simulates a popular British 800-series tube guitar amp head.
US METAL	Simulates a popular US high gain metal guitar amplifier.
60's COMBO	Simulates a popular tube combo guitar amplifier.

You can choose from three guitar amp simulation effects: BRIT STACK, US METAL and 60's COMBO (the selected key lights up).

Applying external effects

During recording, you can apply external effects to a sound source connected to an input connector in the [INPUT A] channel.

The [INPUT A] channel has the [INSERT] connector (phone jack). You can connect an external effect unit (typically, a compressor/limiter) to this connector using a Y-cable, as shown below.

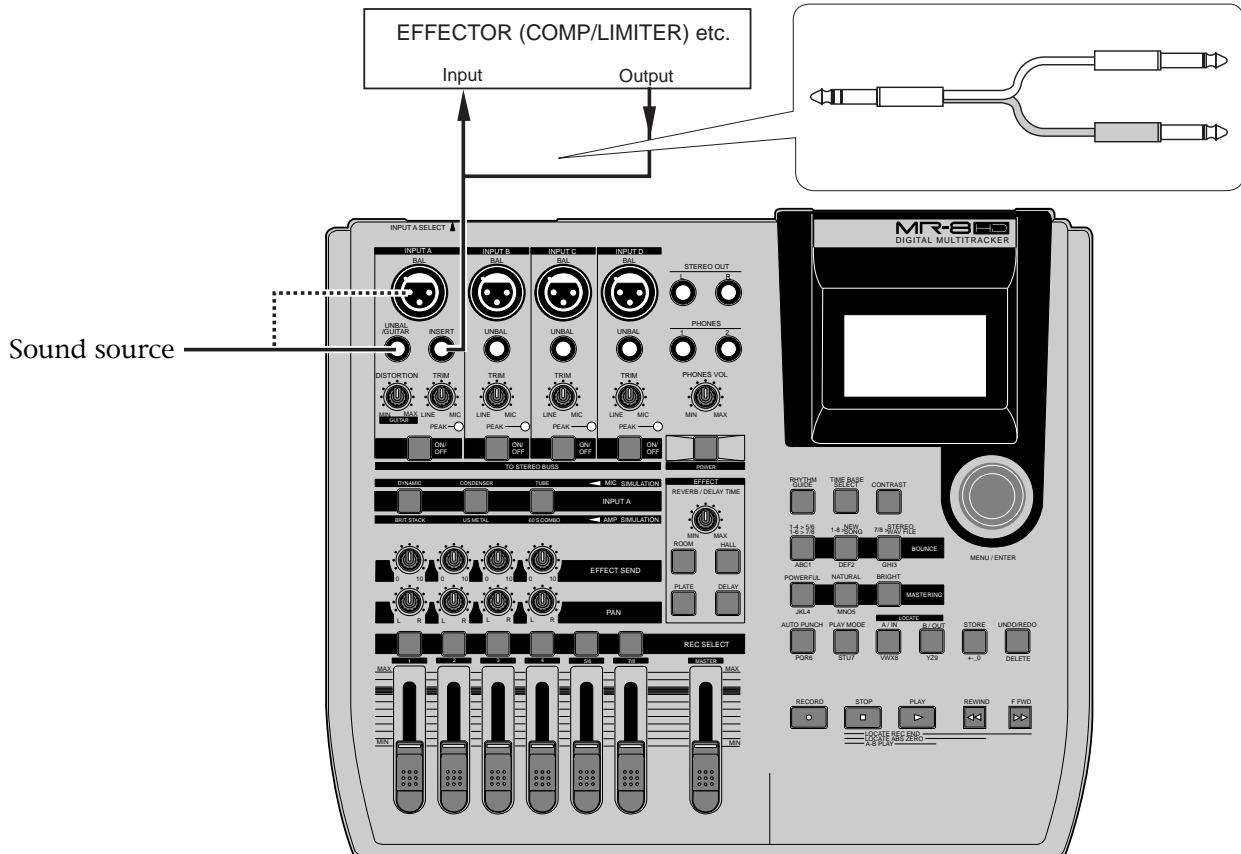

The source (dry) signal fed to the [INPUT A] channel is sent to the external effect unit connected to the [INSERT] connector and the wet (effect) signal returns to the [INPUT A] channel. Thus, you can apply effects to the "INPUT A" signal by connecting an external effect unit.

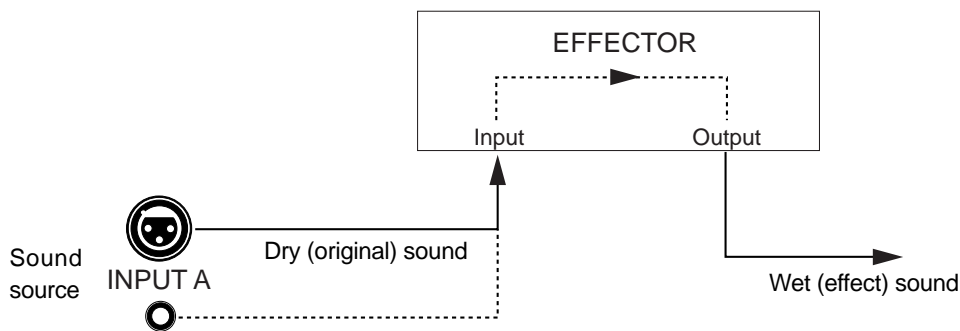

See the manual of your effect unit for details about how to use it.
A Y-cable is not supplied with the MR-8HD, therefore, purchase an appropriate Y-cable available in the market.

Using the reverb or delay

The MR-8HD has the original built-in reverb/delay processor featuring the newly-developed algorithm. You can apply the reverb or delay to playback signals of tracks 1 through 4 during mixdown and track bouncing.

Selecting an effect type

You can select an effect type from among three reverb options (ROOM, HALL and PLATE) and a delay (DELAY) by using the keys in the [EFFECT] section shown below.

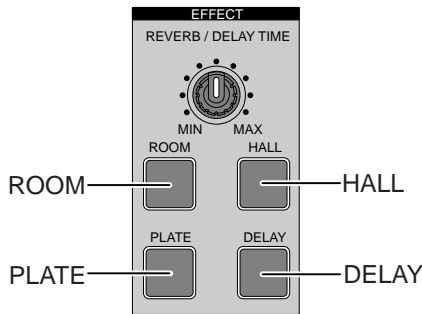

Details of each effect type

ROOM	Simulates reverberation in a medium-sized room. When you select "ROOM", you can adjust the reverb time using the [REVERB/DELAY TIME] control.
HALL	Simulates reverberation in a hall with moderate early reflection. When you select "HALL", you can adjust the reverb time using the [REVERB/DELAY TIME] control.
PLATE	Simulates a plate reverb with a wide frequency range. When you select "PLATE", you can adjust the reverb time using the [REVERB/DELAY TIME] control.
DELAY	<p>Adds delay effects. You can select the desired delay types using the "Delay Type" item of the System menu in the menu mode (you can easily access to the "Delay Type" setting screen by a long press of the [DELAY] key).</p> <p>Three delay types are available: Mono, L-R and Diff. See below for details.</p> <p>When you select "ROOM", you can adjust the delay time using the [REVERB/DELAY TIME] control.</p>

Selecting a delay type

When you use the delay effect, you can select a delay type.

- 1) **While the recorder is stopped, press the [MENU/ENTER] knob to enter the menu mode.** The display now shows the first page of the menu selection screen, where "<< Back" is highlighted initially.

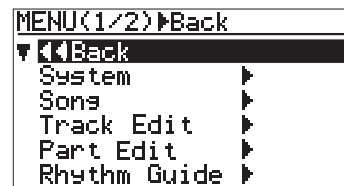

- 2) **Rotate the [MENU/ENTER] knob to select "System", and press the [MENU/ENTER] knob.** The display now shows the system menu screen, where "<< Back" is highlighted.

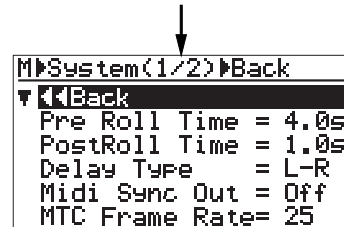
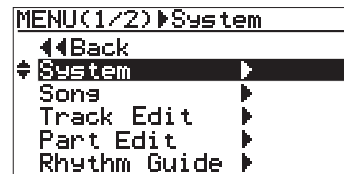

- 3) **Rotate the [MENU/ENTER] knob to select "Delay Type" and press the [MENU/ENTER] knob.** The current delay type starts flashing and you can now select from among three options shown below ("L-R" is initially selected).

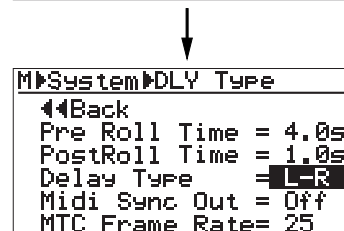
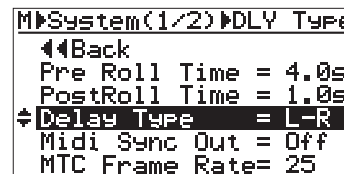

You can choose from among the following three delay types.

L - R	L-R delay (default)
Mono	Mono delay
Diff	Diffusion delay

- 4) **Rotate the [MENU/ENTER] knob to select the desired delay type and press the [MENU/ENTER] knob.**

The selected delay type is set, while the display returns to the previous screen.

- 5) **Press the [STOP] key to quit the menu mode.**

Adjusting the effect send levels

To apply the effect (reverb or delay) to tracks 1 through 4, adjust the [EFFECT SEND] control for each track to adjust the level of the track signal sent to the effect processor.

In the example as illustrated below, tracks 1 and 2 signals are sent to the effect processor.

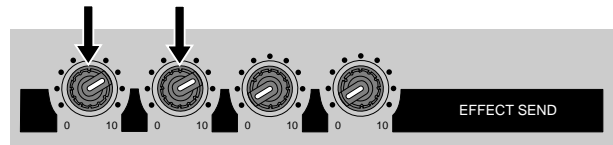

Adjusting the delay/reverb time

You can adjust the reverb time or delay time using the [REVERB/DELAY TIME] control, depending on the selected effect type.

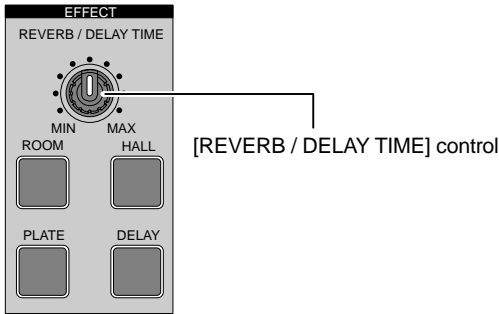

HALL	Adjusts the reverb time within the range between 1.0 s and 6.0 s (center position: 3.0 s)
ROOM	Adjusts the reverb time within the range between 0.1 s and 2.0 s (center position: 1.0 s)
PLATE	Adjusts the reverb time within the range between 0.5 s and 4.0 s (center position: 2.0 s)
DELAY	Adjusts the delay time within the range between 100 ms to 1000 ms (center position: 300 ms)

As shown in the signal flowchart below, a track (playback) signal after the track fader is fed to the [EFFECT SEND] control and adjusted, then fed to the effect processor input.

The effect processor's stereo output signals (wet signals) and stereo (L/R) signals (dry signals) are merged together and then output from the [STEREO OUT] jacks.

As you can see in the flowchart below, the signal sent to the effect processor is affected by the track fader (i.e. a track fader must be raised to send track signal to the effect processor). The signal which passes through a fader is generally called a "post fader signal".

<Signal flow from a track to the effect processor (only Track 1~ 4)>

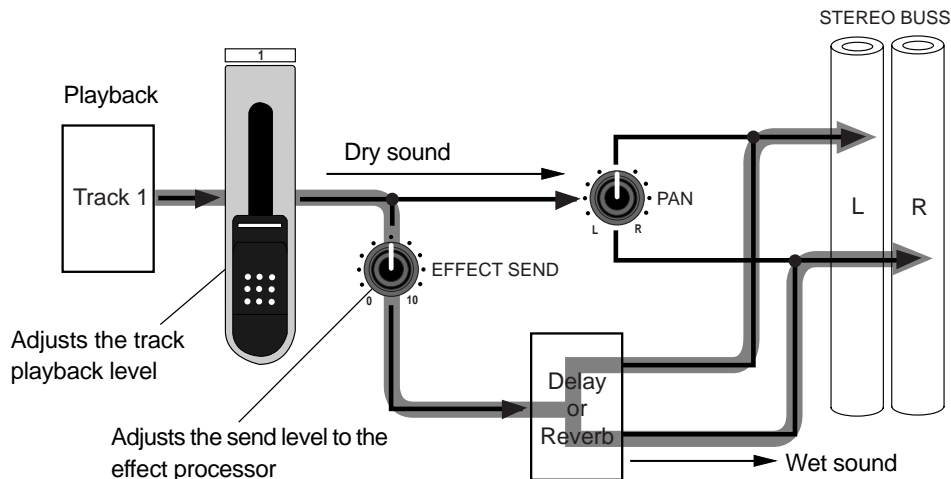

Using the mastering effects

The MR-8HD provides the dedicated mastering effects for the L/R stereo buss. You can use the mastering effects when bouncing more than one track to stereo tracks or when mixing down tracks 1 through 8 to stereo and sent to an external master recorder for recording.

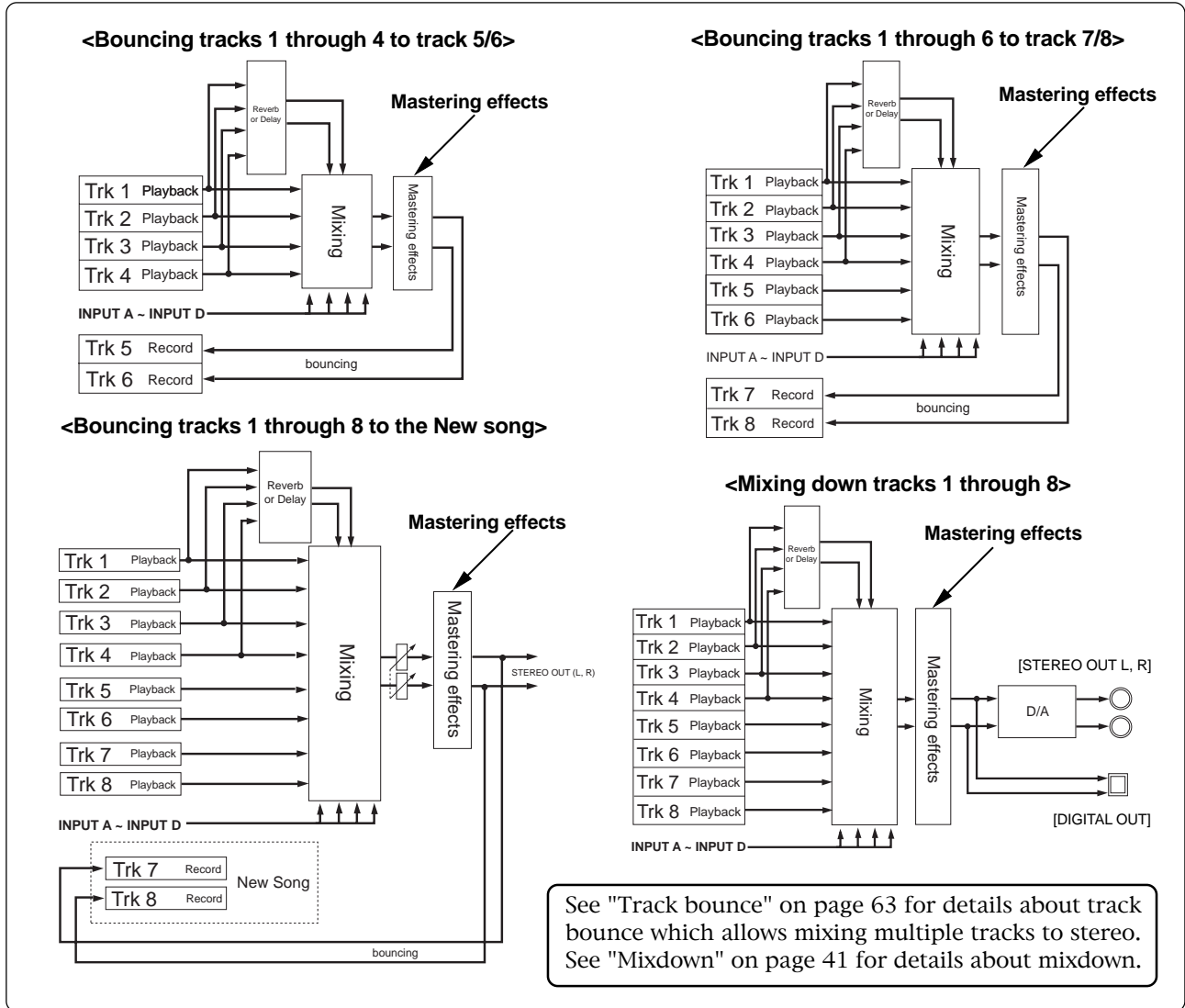

Selecting the desired effect type

Three mastering effect types are available. You can select the desired type using the [MASTERING] keys (POWERFUL, NATURAL and BRIGHT).

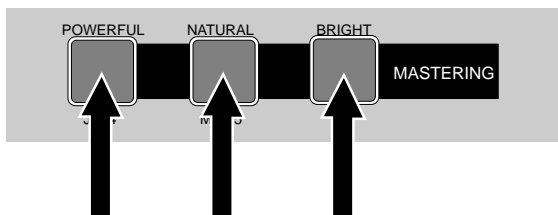

Each effect type has the following character. Select the appropriate type.

POWERFUL	Adds power to the sound. Good for rock.
NATURAL	Slightly adds power to the sound. Good for acoustic music.
BRIGHT	Add brightness to the sound. Good for use when the mixed sound is dark.

<Note>: By activating the mastering effect, the output level raises. Therefore, be careful of the level change when monitoring via headphones or monitor speakers, as well as when adjusting the recording level of an external recorder.

Track bouncing

This chapter describes track bouncing which is an important function in the recording process.

The track bouncing mixes several tracks and records onto other two tracks. By using this function, you can record more sound materials to the MR-8HD tracks.

Three track bouncing modes are available:

- (1) Bouncing tracks 1 through 4 to tracks 5/6.**
- (2) Bouncing tracks 1 through 6 to tracks 7/8**
- (3) Bouncing tracks 1 through 8 to tracks 7/8 of a new song.**

In any mode, you can apply a reverb (or delay) to tracks 1 through 4 when bouncing to two tracks in stereo. Furthermore, you can apply the mastering effect to the mixed signals. You can also execute track bouncing while mixing sound sources from inputs A through D.

Preliminary knowledge

Before executing track bouncing, read "Track bouncing example" below and "Track bouncing signal flow" on the next page.

Track bouncing example

You can record more than eight materials using the track bouncing function as shown in the following example.

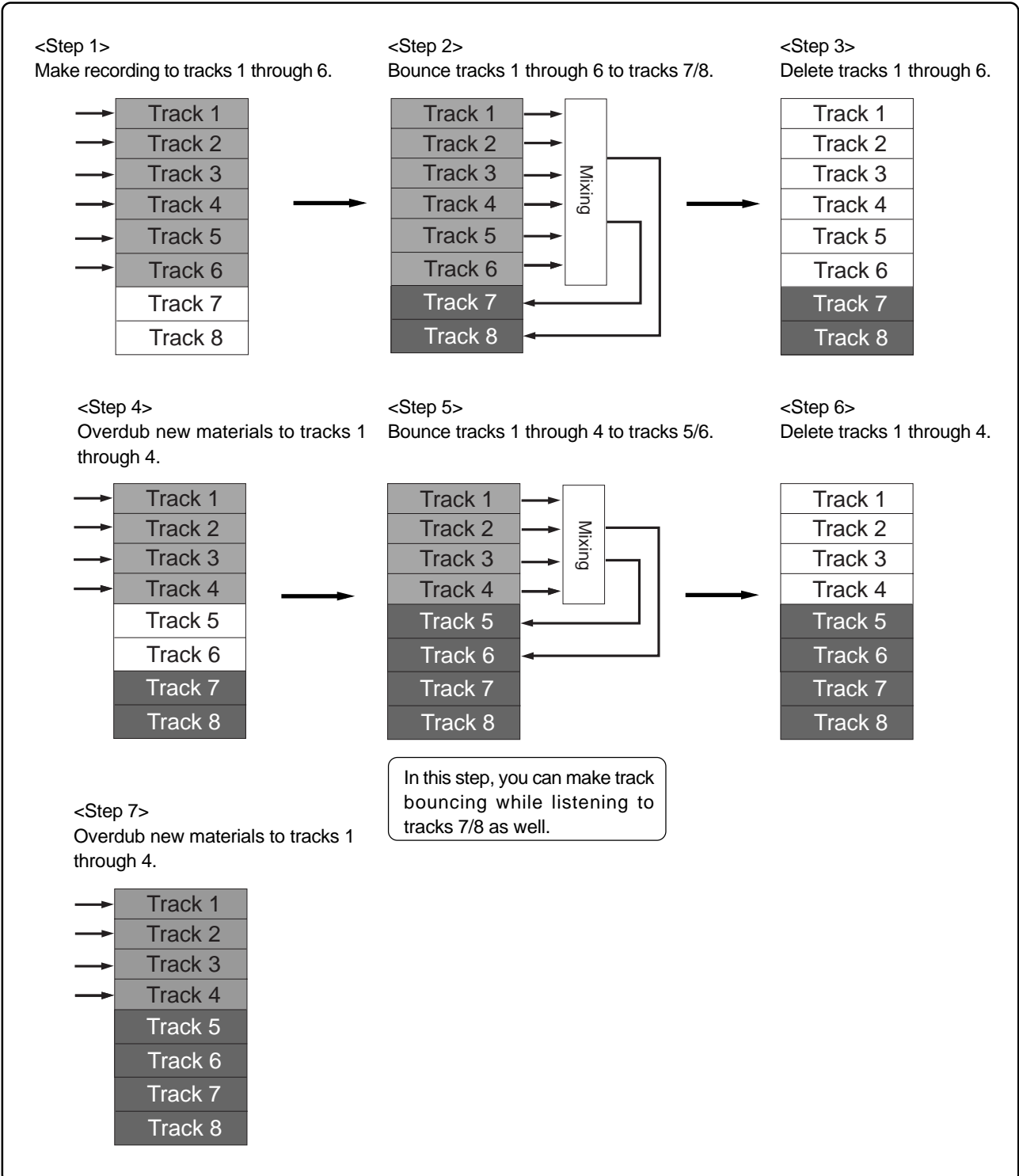

Signal flow of track bouncing

The following shows the signal flow for each of three track bouncing modes.

• "1-4 > 5/6" mode (see page 66)

In the "1-4 > 5/6" mode, tracks 1 through 4 are played back, mixed down to stereo, and bounced to tracks 5/6.

You can apply a reverb (or delay) to tracks 1 through 4, as well as the mastering effect to the mixed signals.

You can also mix signals from the [INPUT A] through [INPUT D] channels during track bouncing.

From headphones (or monitor speakers), you can hear the signals bounced to tracks 5/6 (i.e. mixed signals) as well as playback signals of tracks 7/8.

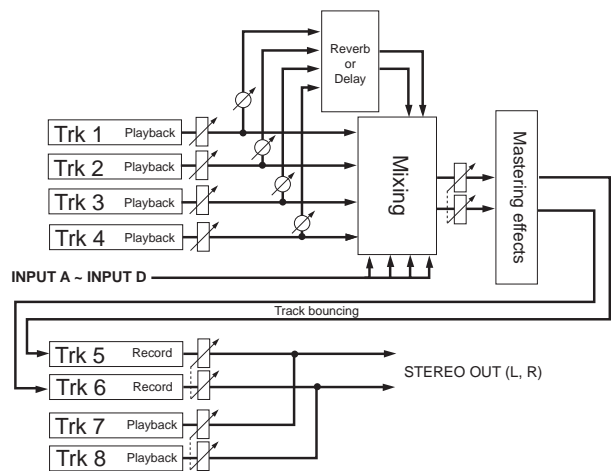

• "1-6 > 7/8" mode (see page 68)

In the "1-6 > 7/8" mode, tracks 1 through 6 are played back, mixed down to stereo, and bounced to tracks 7/8.

In this mode, you can apply a reverb (or delay) to tracks 1 through 4, as well as the mastering effect to the mixed signals.

You can also mix signals from the [INPUT A] through [INPUT D] channels during track bouncing.

From headphones (or monitor speakers), you can hear the signals bounced to tracks 7/8 (i.e. mixed signals).

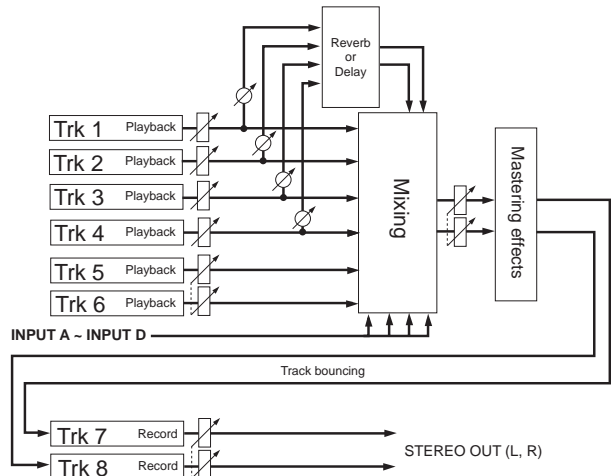

• "1-8 > NEW SONG" mode (see page 70)

In the "1-8 > NEW SONG" mode, tracks 1 through 8 are played back, mixed down to stereo, and bounced to tracks 7/8 of a new song which is automatically created. So this bouncing mode allows you to internally record a stereo master without the need of an external master recorder.

In this mode, you can apply a reverb (or delay) to tracks 1 through 4, as well as the mastering effect to the mixed signals.

You can also mix signals from the [INPUT A] through [INPUT D] channels during track bouncing.

From headphones (or monitor speakers), you can hear the signals bounced to tracks 7/8 of the new song.

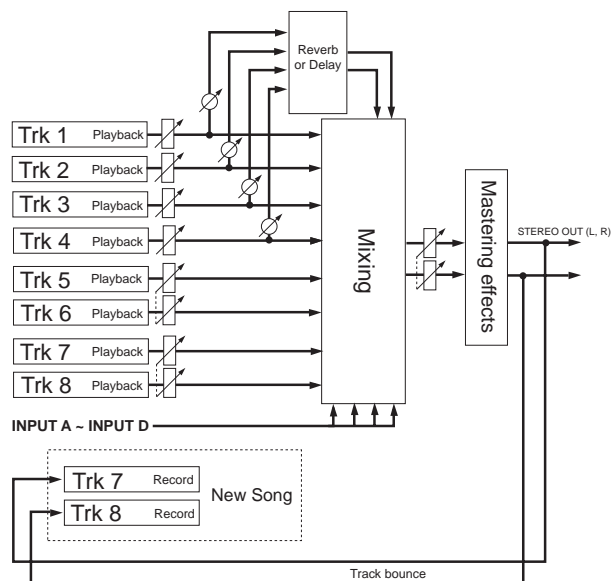

Bouncing tracks 1 through 4 to tracks 5/6

You can bounce tracks 1 through 4 to tracks 5/6. Before executing track bouncing, you can rehearse track bouncing as many times as you like.

Rehearsal of track bouncing

Before executing track bouncing, you can rehearse it. While rehearsing track bouncing, you can control the playback level, panning and reverb (or delay) send setting of each source track, as well as apply the mastering effect to the mixed L/R signals. We recommend to make rehearsal thoroughly until you are satisfied with the sound.

The following assumes that the song you are going to execute track bouncing is loaded.

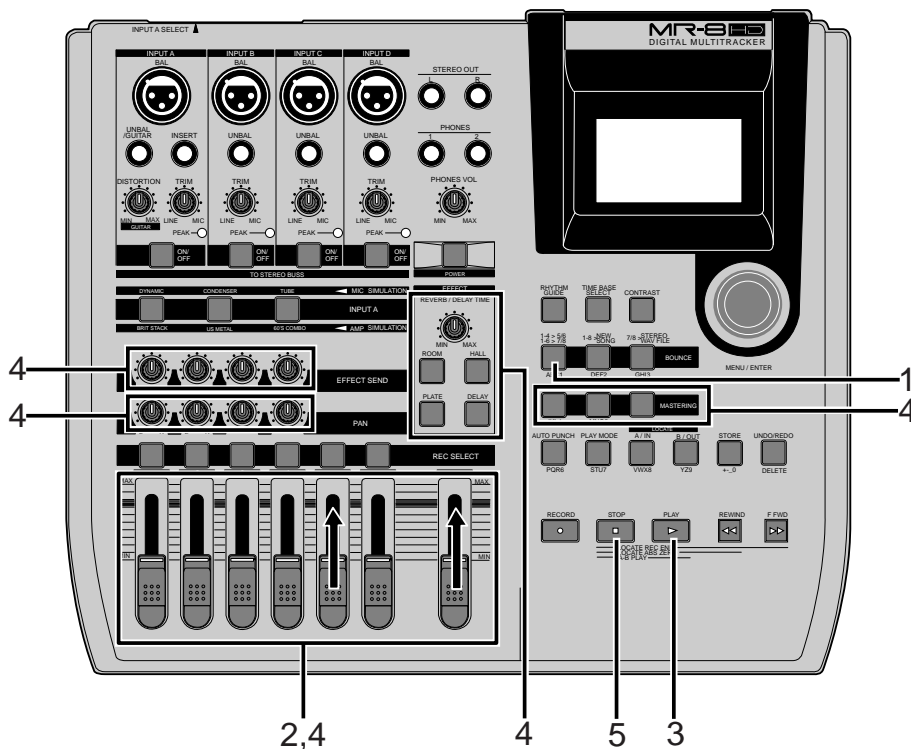

- 1) Use the [1-4 > 5/6, 1-6 > 7/8] key to select the "1-4 > 5/6" bounce mode. Selecting this bounce mode automatically arms tracks 5/6 and changes the monitoring mode for these tracks to input monitoring mode. The display looks like this:
- 3) Press the [PLAY] key to start playback from the beginning of the song.
- 4) While playing back the song, adjust playback levels of tracks 1 through 4 using the track faders. You can also adjust panning for tracks 1 through 4 and apply the reverb or delay to these tracks, as well as apply the mastering effect to the mixed sound.

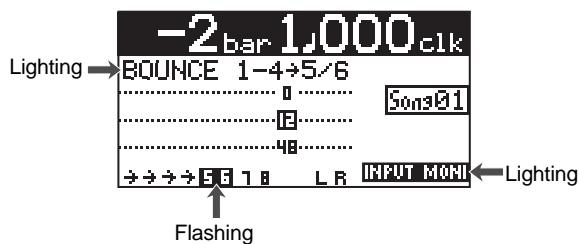

- 2) Raise the [5/6] fader and [MASTER] fader to the "III" position. Set all the other track faders down to the minimum position.

During rehearsal and actual track bouncing, the track faders and [MASTER] fader control the following signals.

Faders 1 through 4	Playback levels of tracks 1 through 4 for bouncing.
Fader 5/6	Monitor levels of tracks 5/6.
[MASTER] fader	Recording master level of tracks 5/6.

During rehearsal and actual track bouncing, level meters on the screen show the following signal levels.

Meters 1 through 4	Playback levels of tracks 1 through 4.
Meters 5/6	Recording levels of tracks 5/6.
Meters L and R	Monitor output levels of STEREO OUT (L, R).

By raising the [PHONES VOL] control, you can hear the signals bounced to tracks 5/6.

Use the [5/6] fader to control the monitor output levels, and use the [MASTER] fader to adjust the recording levels of the bounced signals appropriately while checking meters 5/6.

You can apply the delay/reverb to tracks 1 through 4 and the mastering effects to the stereo L and R signals. See "Using effects" on page 57 for details about the delay/reverb and mastering effects.

<Panning control>

You can freely adjust panning for tracks 1 through 4 using the PAN controls. For example, a guitar to left, a vocal to center, etc.

- 5) **After finishing rehearsal, press the [STOP] key to stop the recorder and locate it to the beginning of the song.**

Do not move the controls and faders after finishing rehearsal.

Actual track bouncing

After finishing rehearsal, let's carry out actual track bouncing. Make sure that the recorder stops at the beginning of the song.

- 1) **Before carrying out actual track bouncing, make sure that the bounce mode is selected to "1-4>5/6".**
- 2) **Press the [PLAY] key while holding down the [RECORD] key.**
Track bouncing starts with the effect/level settings made in the rehearsal mode. The mixed signals are recorded onto tracks 5/6.
- 3) **After track bouncing completes, press the [STOP] key to stop the recorder.**
Stopping the recorder automatically turns off the input monitoring mode of tracks 5/6.

Checking the bounced signals on tracks 5/6

You can check the bounced signals while the bounce mode is active.

- 1) **Press the [REWIND] key while holding down the [STOP] key to locate the recorder to the beginning of the song.**
- 2) **Make sure that the input monitoring mode is turned off.**
- 3) **Press the [PLAY] key to start playback from the beginning of the song.**
- 4) **Use the [5/6] fader to control the playback level of the bounced signals.**

By playing back the recorder while the bounce mode ("1-4 > 5/6") is active, only tracks 5/6 can be monitored. In this condition, you cannot monitor playback signals of tracks 1 through 4 even if you raise their faders.

If you want to redo track bouncing, use the undo function to go back to the condition before carrying out track bouncing, and try again.

<Auto punch in/out of track bouncing>

You can bounce only the desired part (between the IN and OUT points) using the auto punch in/out function (see page 74).

<Track bouncing while mixing signals from [INPUT A] through [INPUT D]>

When you bounce tracks 1 through 4 to tracks 5/6, you can also mix signals from [INPUT A] through [INPUT D] together (see page 72).

Bouncing tracks 1 through 6 to tracks 7/8

You can bounce tracks 1 through 6 to tracks 7/8.

As described earlier in "Bouncing tracks 1 through 4 to tracks 5/6", you can rehearse track bouncing as many times as you like before executing actual track bouncing.

Rehearsal of track bouncing

Before executing track bouncing, you can rehearse it. While rehearsing track bouncing, you can control the playback level, panning and reverb (or delay) send setting of each source track, as well as apply the mastering effect to the mixed L/R signals. We recommend to make rehearsal thoroughly until you are satisfied with the sound.

The following assumes that the song you are going to execute track bouncing is loaded.

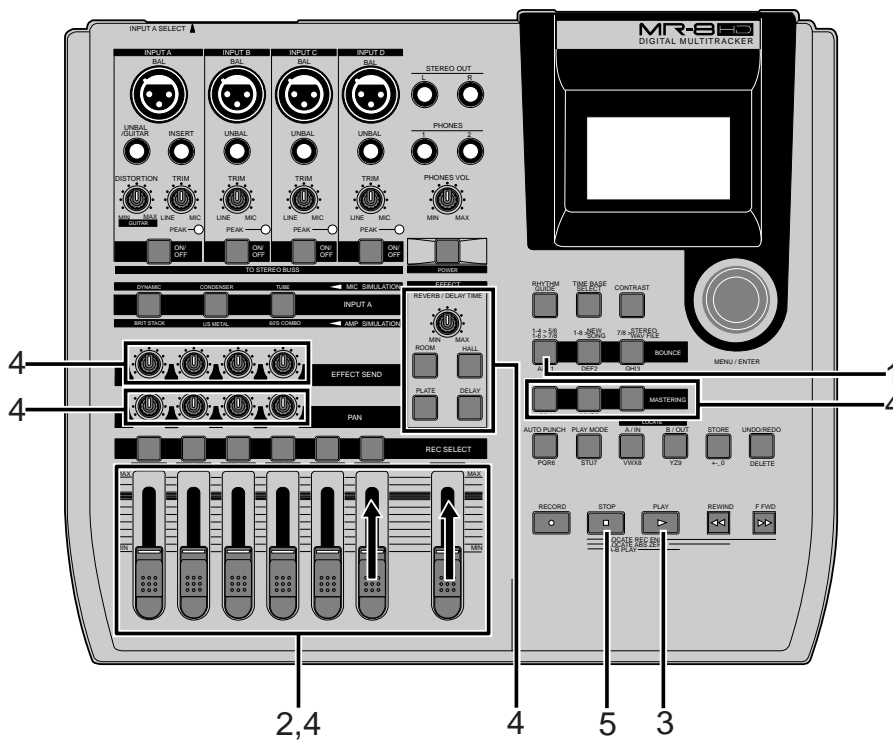

- 1) Use the [1-4 > 5/6, 1-6 > 7/8] key to select the "1-6 > 7/8" bounce mode. Selecting this bounce mode automatically arms tracks 7/8 and changes the monitoring mode for these tracks to input monitoring mode. The display looks like this:

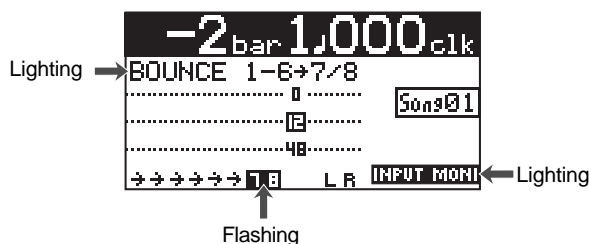

- 2) Raise the [5/6] fader and [MASTER] fader to the "III" position. Set all the other track faders down to the minimum position.

- 3) Press the [PLAY] key to start playback from the beginning of the song.
- 4) While playing back the song, adjust playback levels of tracks 1 through 6 using the track faders. You can also adjust panning for tracks 1 through 4 and apply the reverb or delay to these tracks, as well as apply the mastering effect to the mixed sound.

During rehearsal and actual track bouncing, the track faders and [MASTER] fader control the following signals.

Faders 1 through 4	Playback levels of tracks 1 through 4 for bouncing.
Fader 5/6	Playback levels of tracks 5/6 for bouncing.
Fader 7/8	Monitor levels of tracks 7/8.
[MASTER] fader	Recording master level of tracks 7/8.

During rehearsal and actual track bouncing, the level meters on the screen show the following signal levels.

Meters 1 through 4	Playback levels of tracks 1 through 4.
Meters 5/6	Recording levels of tracks 5/6.
Meters 7/8	Recording levels of tracks 7/8.
Meters L and R	Monitor output levels of STEREO OUT (L, R).

By raising the [PHONES VOL] control, you can hear the signals bounced to tracks 7/8.

Use the [7/8] fader to control the monitor output levels, and use the [MASTER] fader to adjust the recording levels of the bounced signals appropriately while checking meters 7/8.

You can apply the delay/reverb to tracks 1 through 4 and the mastering effects to the stereo L and R signals. See "Using effects" on page 57 for details about the delay/reverb and mastering effects.

<Panning control>

You can freely adjust panning for tracks 1 through 4 using the PAN controls. For example, a guitar to left, a vocal to center, etc.

- 5) **After finishing rehearsal, press the [STOP] key to stop the recorder and locate it to the beginning of the song.**
Do not move the controls and faders after finishing rehearsal.

Actual track bouncing

After finishing rehearsal, let's carry out actual track bouncing. Make sure that the recorder stops at the beginning of the song.

- 1) **Before carrying out actual track bouncing, make sure that the bounce mode is selected to "1-6>7/8".**
- 2) **Press the [PLAY] key while holding down the [RECORD] key.**
Track bouncing starts with the effect/level settings made in the rehearsal mode. The mixed signals are recorded onto tracks 7/8.
- 3) **After track bouncing completes, press the [STOP] key to stop the recorder.**
Stopping the recorder automatically turns off the input monitoring mode of tracks 7/8.

Checking the bounced signals on tracks 7/8

You can check the bounced signals while the bounce mode is active.

- 1) **Press the [REWIND] key while holding down the [STOP] key to locate the recorder to the beginning of the song.**
- 2) **Make sure that the input monitoring mode is turned off.**
- 3) **Press the [PLAY] key to start playback from the beginning of the song.**
- 4) **Use the [7/8] fader to control the playback level of the bounced signals.**

By playing back the recorder while the bounce mode ("1-6 > 7/8") is active, only tracks 7/8 can be monitored. In this condition, you can not monitor playback signals of tracks 1 through 6 even if you raise their faders.

If you want to redo track bouncing, use the undo function to go back to the condition before carrying out track bouncing, and try again.

<Auto punch in/out of track bouncing>

You can bounce only the desired part (between the IN and OUT points) using the auto punch in/out function (see page 74).

<Track bouncing while mixing signals from [INPUT A] through [INPUT D]>

When you bounce tracks 1 through 6 to tracks 7/8, you can also mix signals from [INPUT A] through [INPUT D] together (see page 72).

<Exporting bounced data to a PC>

Song data bounced to tracks 7/8 can be exported to a PC.

You can use the exported data as a source when burning an original audio CD using a CD-RW drive, or use it with a computer's music software.

Before exporting song data on tracks 7/8 to a PC, you must convert the two mono WAV files on tracks 7/8 to a stereo WAV file (see page 90).

Bouncing tracks 1 through 8 to a new song

You can bounce tracks 1 through 8 to tracks 7/8 of a new song. A new song is automatically created when executing track bouncing (<Note>: In the "1-8 > NEW SONG" mode, you cannot bounce the desired part of a song by using the track bouncing and auto punch in/out functions together).

Rehearsal of track bouncing

Before executing track bouncing, you can rehearse it. While rehearsing track bouncing, you can control the playback level, panning and reverb (or delay) send setting of each source track, as well as apply the mastering effect to the mixed L/R signals. We recommend to make rehearsal thoroughly until you are satisfied with the sound. The following assumes that the song you are going to execute track bouncing is loaded.

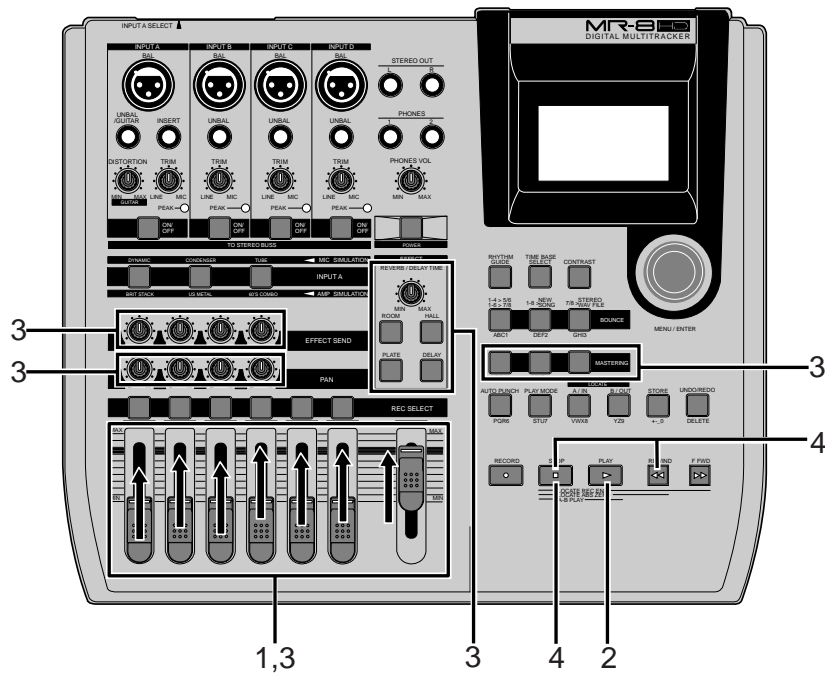

- 1) **Raise the [MASTER] fader to the "III" position. Set all the track faders down to the minimum position.**
- 2) **Press the [PLAY] key to start playback from the beginning of the song.**
- 3) **While playing back the song, adjust playback levels of tracks 1 through 8 using the track faders.**

You can also adjust panning for tracks 1 through 4 and apply the reverb or delay to these tracks, as well as apply the mastering effect to the mixed sound.

During rehearsal and actual track bouncing, the track faders and [MASTER] fader control the following signal levels.

Faders 1 through 8	Playback levels of tracks 1 through 8 for bouncing.
[MASTER] fader	Recording master levels of bouncing.

During rehearsal and actual track bouncing, the level meters on the screen show the following signal levels.

Meters 1 through 8	Playback levels of tracks 1 through 8.
Meters L and R	Output levels of STEREO OUT (= recording levels of bouncing)

By raising the [PHONES VOL] control, you can hear the bounced signals.

Use the track faders (1 through 8) to control the track output levels, and use the [MASTER] fader to adjust the master recording levels of the bounced signals appropriately while checking meters L/R.

See "Using effects" on page 57 for details about the delay/reverb and mastering effects.

- 4) **After finishing rehearsal, press the [STOP] key to stop the recorder and locate it to the beginning of the song.**

Do not move the controls and faders after finishing rehearsal.

Actual track bouncing

After finishing rehearsal, let's carry out actual track bouncing.

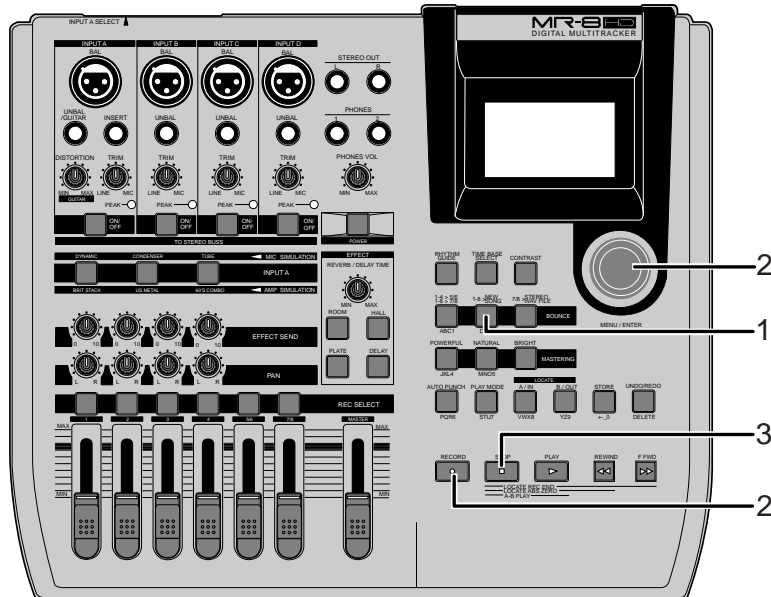

- 1) While the recorder is stopped, press the [1-8 > NEW SONG] key. The [1-8 > NEW SONG] key lights up and the display shows the screen below. If you execute track bouncing, press the [MENU/ENTER] knob while holding down the [RECORD] key. If you cancel track bouncing, press the [STOP] key.

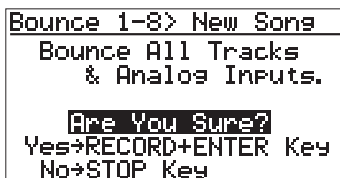

- 2) Press the [MENU/ENTER] knob while holding down the [RECORD] key. Track bouncing starts. The mixed (bounced) signals are recorded to tracks 7/8 of a new song. The screen example below shows that tracks 1 through 8 of Song02 (whose name is "Moonlit") is now being bounced to tracks 7/8 of the new song (Song04). Meters 1 through 8 show the playback levels of tracks 1 through 8, while the L and R meters shows the recording levels of tracks 7/8 of Song04.

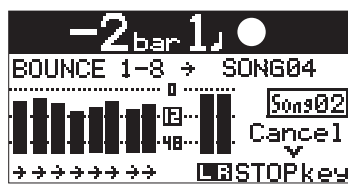

<Note>: To stop track bouncing, press the [STOP] key. Pressing the [STOP] key also turns off the bounce mode. If you stop track bouncing in the middle, the new song is automatically deleted.

<Note>: When you are going to execute track bouncing, if there is not enough space on the hard disk or 99 songs already exist on the disk, a warning message appears and the operation is canceled.

When track bouncing to a new song completes, the recorder automatically stops and the display shows the home screen of the new song.

The song name of the new song is given by the name of the original song with "_**" (** is a two-digit number).



You can check the result by following the procedure described in "Checking the bounced signals on tracks 7/8" on page 69.

<Track bouncing while mixing signals from [INPUT A] through [INPUT D]>

When you bounce tracks 1 through 8 to tracks 7/8 of the new song, you can also mix signals from [INPUT A] through [INPUT D] together (see page 72).

<Exporting bounced data to a PC>

Song data bounced to tracks 7/8 of the new song can be exported to a PC. You can use the exported data as a source when burning an original audio CD using a CD-RW drive, or use it with a computer's music software (see page 90).

Mixing signals of inputs A through D

The MR-8HD can mix input signals of [INPUT A] through [INPUT D]. The following diagram shows an example of mixing signals of INPUT A through INPUT D when bouncing tracks 1 through 6 to tracks 7/8. As you can see, the signals of INPUT A through INPUT D are mixed to the L/R stereo buss together with the bounced signals.

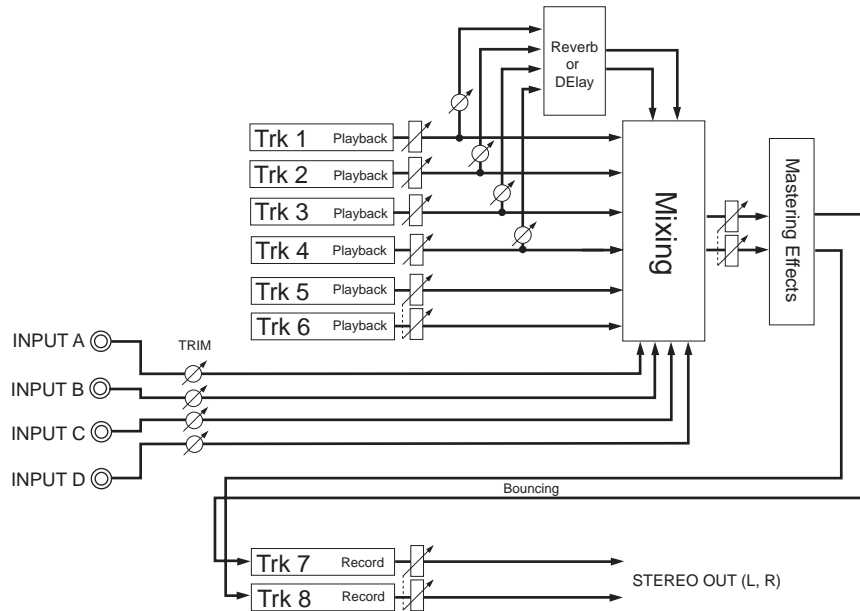

Connecting sound sources to INPUT A through INPUT D

Before starting track bouncing, connect the desired sound source(s) to any desired input(s) between INPUT A and INPUT D.

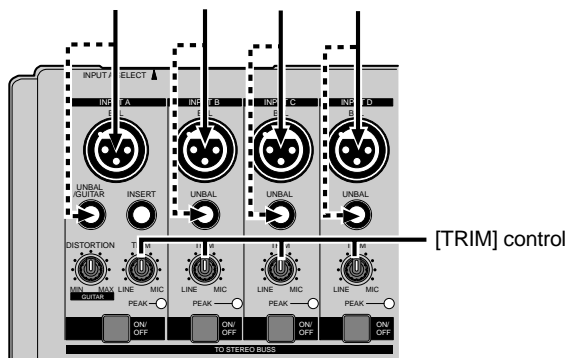

Adjust the input level of each input using the [TRIM] control to match the balance with the bounced track levels. Also, you can adjust panning of each input for stereo mix. See the next page for details about how to set panning.

[TO STEREO BUSS ON/OFF] key setting

To mix the input signal of an input channel (any of INPUT A through INPUT D) to the L/R stereo buss, turn on the corresponding [TO STEREO BUSS ON/OFF] switch.

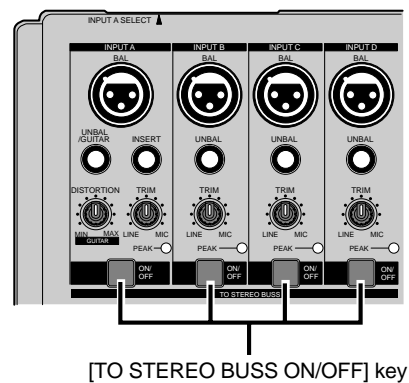

When the [TO STEREO BUSS ON/OFF] key is turned on, the key illuminates in green. That is, when the key illuminates, input signal is sent to recording tracks. (Note that when the key flashes, the corresponding input is assigned to any recording track.)

<Note>: If you press the [TO STEREO BUSS ON/OFF] key when make recording other than track bouncing, the key lamp may flash. This shows the input signal is routed to the armed track. That is, the input signal will be recorded to the armed track, in stead of mixed to the stereo buss.

Panning setting for INPUT A through INPUT D

You can independently set panning for each of INPUT A through INPUT D. Each input signal is positioned in the mix according to the panning setting here.

- 1) While the recorder is stopped, press the [MENU/ENTER] knob to enter the menu mode.

The display now shows the first page of the menu selection screen.

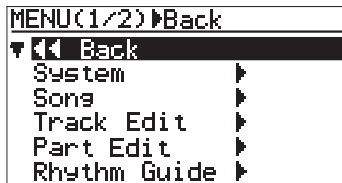

- 2) Rotate the [MENU/ENTER] knob to select "Input" on the second page, and press the [MENU/ENTER] knob.

The display now shows the input menu screen.

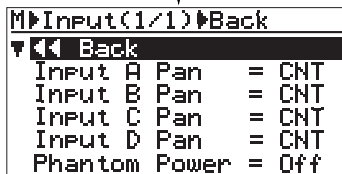
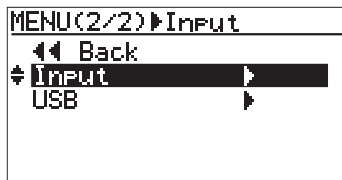

The default panning settings are as below. You can set each input to the desired panning position from L10 (hard left) to R10 (hard right).

Input A	CNT (center position)
Input B	CNT (center position)
Input C	CNT (center position)
Input D	CNT (center position)

<Tip>: You can directly access to the input menu screen by a long press of the [TO STEREO BUSS ON/OFF] key of the desired input channel. On the input menu screen accessed in this way, the panning setting item for the corresponding input is highlighted.

For example, a long press of the [TO STEREO BUSS ON/OFF] key of [INPUT D] directly accesses to the screen shown below.

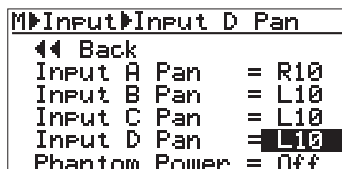

- 3) Rotate the [MENU/ENTER] knob to select the desired item (any one of "Input A Pan" through "Input D Pan"), and press the [MENU/ENTER] knob.

The display shows the screen for making panning setting of the selected input.

The current setting flashes.

In the screen example below, "Input A Pan" is selected and the default "CNT" is flashing.

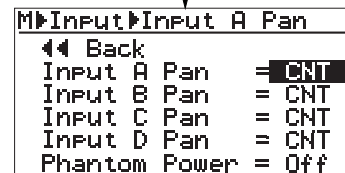
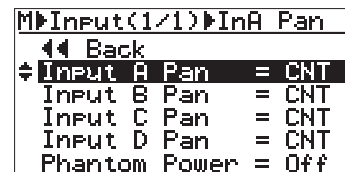

You can select the desired panning value from among R01 through R10 and L01 through L10, as well as "CNT" (center).

- 4) Rotate the [MENU/ENTER] knob to select the desired value, and press the [MENU/ENTER] knob.

The panning is set and the display returns to the previous screen.

In the screen example below, "Input A Pan" is set to "R10".

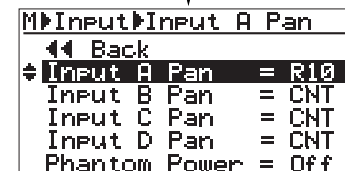
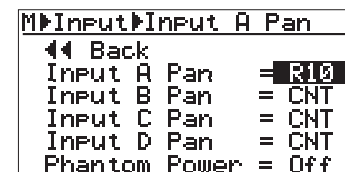

You can also make panning setting of another input in the same manner as above.

- 5) Press the [STOP] key to exit the menu mode.

By selecting "<< Back" and pressing the [NETER] key, the display returns to the previous screen. Therefore, you can also exit the menu mode by repeating this operation.

Bouncing the desired part of a song

Typically, bouncing is executed from the beginning to the end of a song, as shown in Figure 1 below. However, you can bounce only the desired part by using the track bouncing and punch in/out functions together. The following assumes that the song you are going to execute track bouncing is loaded and you finished rehearsal of track bouncing.

The following procedure shows the example of bouncing the desired part of a song in the "Bounce 1-6 > 7/8" mode (**<Note>**: In the "1-8 > NEW SONG" mode, you cannot bounce the desired part of a song by using the track bouncing and auto punch in/out functions together).

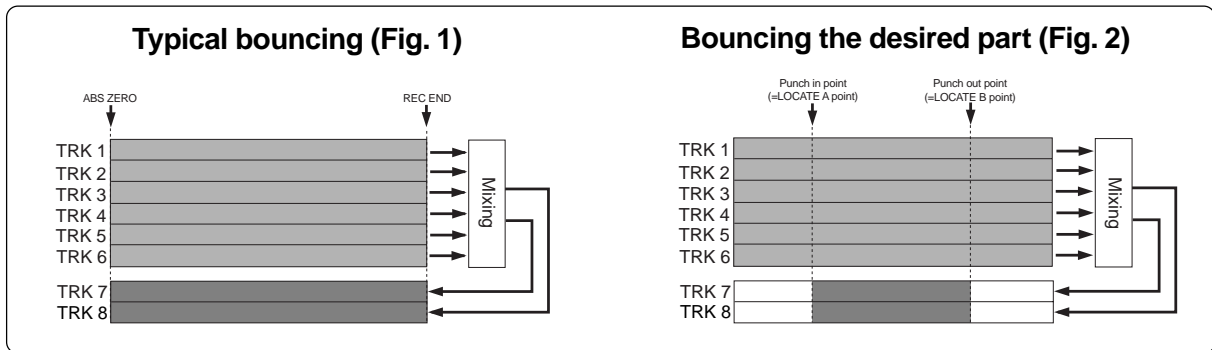

- 1) **Set the punch-in and punch-out points (see page 54).**

By pressing the [PLAY] key while holding down the [STOP] key, you can play back the part between the punch-in and punch-out points (see page 44).

- 2) **Locate the recorder to a position before the punch-in point.**

- 3) **Press the [1-4>5/6, 1-6>7/8] key to set the bounce mode to "1-6>7/8".**

When setting the bounce mode to "1-6>7/8", tracks 7/8 automatically enter the input monitor mode and "INPUT MONI" lights on the home screen.

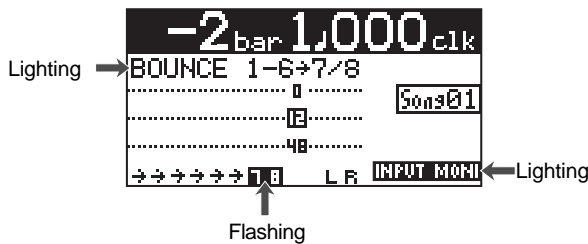

- 4) **Press the [AUTO PUNCH] key to activate the auto punch mode.**

When the auto punch mode is active, "AUTO PUNCH" lights on the home screen.



- 5) **Press the [RECORD] key while holding down the [PLAY] key.**

The "TAKE" icon is shown and the recorder starts playback. It automatically starts recording (bouncing) when it reaches the punch-in point.

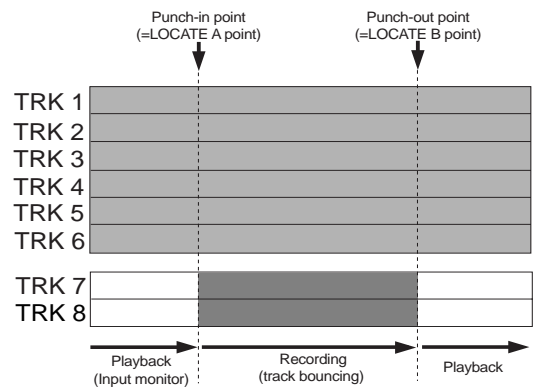

The recorder stops recording (bouncing) at the punch-out point and returns to playback, while the auto punch mode exits and "TAKE" in the screen turns off.

<Note>: During playback in the operation above, you cannot monitor the sound. You can monitor the sound (bounced sound) only during recording between punch-in and punch-out points.

- 6) **Press the [STOP] key to stop the recorder.**

Check the result by playing back the bounced tracks, as described earlier.

<Note>: If you are not satisfied with the result, press the [UNDO/REDO] key to redo the operation.

Rhythm guide function

The MR-8HD offers the rhythm guide function, which allows outputting the rhythm guide click during recording.

This chapter describes how to output the rhythm guide, set the time signature/tempo and create the conductor map.

Using the rhythm guide function

The MR-8HD provides the metronome function which can output the rhythm guide click during recording. You can easily output the guide click from the [STEREO OUT] jacks by pressing the [RHYTHM GUIDE] key on the top panel. Two types of the rhythm guide are available: one has the constant time signature/tempo throughout a song, while the other has the programmed time signature/tempo map.



To output the rhythm guide click, turn on the [RHYTHM GUIDE] key. By default, the guide click is output at time signature=4/4, tempo=120.

You can output the rhythm guide click according to the desired constant time signature and tempo, as well as the programmed rhythm guide click based on the conductor map.

When recording starts, the MR-8HD simultaneously starts feeding the rhythm guide click from the [STEREO OUT (L, R)] jacks at the selected level (the default is 80). Note that the rhythm guide click is not output during track bouncing. The output level of the rhythm guide click is shown on the L and R level meters. Note that you can monitor the rhythm guide click via headphones or (a) monitor speaker(s). You cannot record the rhythm guide click to any MR-8HD track(s). If you do not want to output the rhythm guide click, turn off the [RHYTHM GUIDE] key.

Setting the time signature and tempo

You can set the default rhythm guide (time signature: 4/4, tempo: 120), output level, etc. using the "Rhythm Guide" menu in the menu mode.

- 1) While the recorder is stopped, press the [MENU/ENTER] knob to enter the menu mode. The display now shows the first page of the menu selection screen, where "<< Back" is highlighted initially (selecting "<< Back" returns to the previous screen).

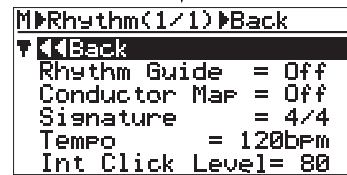
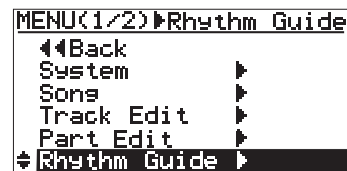
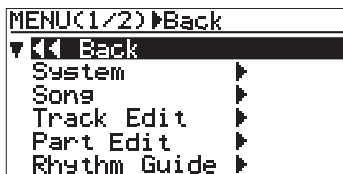

- 2) Rotate the [MENU/ENTER] knob to select "Rhythm Guide", and press the [MENU/ENTER] knob. The display now shows the screen for setting the rhythm guide, where "<< Back" is highlighted.

Tip!: While the home screen is shown and the recorder is stopped, long press of the [RHYTHM GUIDE] key directly brings up the screen for setting the rhythm guide.

- 3) Rotate the [MENU/ENTER] knob to select the desired item, and press the [MENU/ENTER] knob. The current setting of the selected item starts flashing. On the screen examples below, the "Rhythm Guide" item is highlighted (see the upper screen) and the [MENU/ENTER] knob is pressed (see the lower screen).

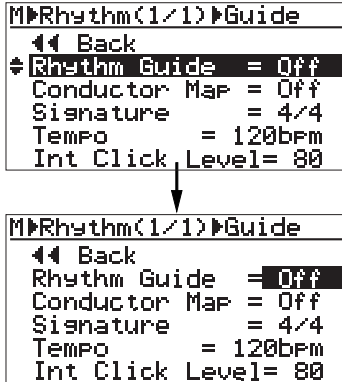

- 4) Rotate the [MENU/ENTER] knob to select the desired option, and press the [MENU/ENTER] knob. The selected option (in the example above, "On" or "Off") is confirmed and the display returns to the previous screen.

You can make setting for each item similarly. The rhythm guide setting screen has the following items.

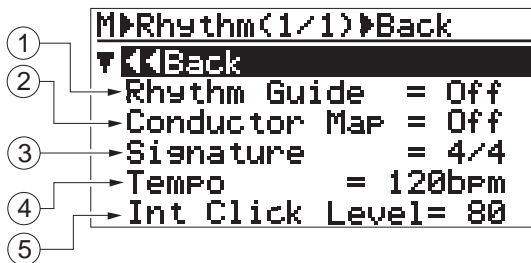

- Rhythm Guide: On/off selection of the rhythm guide**
The setting you make here is reflected to the [RHYTHM GUIDE] key (the key is lit when ON, while it is unlit when OFF). Conversely, when you turn on or off the rhythm guide using the [RHYTHM GUIDE] key, the status is reflected to this screen. See the table on the right for details.
- Conductor Map: On/off selection of the conductor map**
This item enables or disables the conductor map (see "Conductor map" described later). The default is "Off". See the table on the right for details.
- Signature: Time signature setting**
The default is "4/4". You can select from among 1/4 through 5/4 and 1/8 through 8/8. The setting here is effective from the beginning to the end of the song when the "Conductor Map" item is set to "Off" (i.e. the same time signature all through the song). When the "Conductor Map" item is set to "On", the setting here is ineffective. See the table on the right for details.

- Tempo: Tempo setting**
The default is "120bpm". You can select between 30 and 250 bpm. The setting here is effective from the beginning to the end of the song when the "Conductor Map" item is set to "Off" (i.e. the same tempo all through the song). When the "Conductor Map" item is set to "On", the setting here is ineffective. See the table on the below for details.
- Int ClickLevel: Internal click output level**
The default is "80". You can set it between 0 and 99.

To exit the menu mode, press the [STOP] key, or select "<< Back" and press the [MENU/ENTER] knob repeatedly.

The table below shows how the "Rhythm Guide" and "Conductor Map" item settings affect the conditions of rhythm guide output and bar/beat indication.

On/off conditions	Rhythm guide	Bar/beat indication
Rhythm Guide: Off Conductor Map: Off	No output	The "Signature" and "Tempo" item settings are effective.
Rhythm Guide: Off Conductor Map: On	No output	The conductor map is effective.
Rhythm Guide: On Conductor Map: Off	Output: The tempo and time signature setting on this screen is effective.	The "Signature" and "Tempo" item settings are effective.
Rhythm Guide: On Conductor Map: On	Output: The conductor map setting is effective.	The conductor map is effective.

<Note>: When "Conductor Map" is set to "On", the "Signature" and "Tempo" fields show "---" as below. This indicates that the signature and tempo values set on this screen are ineffective, while the conductor map setting is effective.

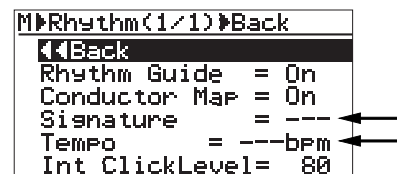

See the next page for details about how to set the conductor map.

Creating the conductor map

The MR-8HD can output the rhythm guide click which follows the "conductor map" during recording. It can also output MIDI clock and song position pointer which follows the "conductor map" from the [MIDI OUT] connector.

The conductor map consists of the time signature map and tempo map. You can add "events" to each map. Each event specifies the time signature or tempo, as well as the position from which the specified time signature or tempo is effective. The time signature or tempo specified by each event is effective until the next event in the map appears.

For example, if the time signature map has two events -- one sets "4/4" at the first bar 1, while the other sets "2/4" at the third bar --, the song is played in 4/4 from bar 1 to 2, and played in 2/4 from bar 3 to the end.

For another example, if the tempo map has two events -- one sets "120" at the first bar 1/first beat while the other sets "90" at bar 12/beat 2 --, the song is played at 120 bpm from bar 1 to bar 12/beat 1, while it is played at 90 from bar 12/beat 2 to the end.

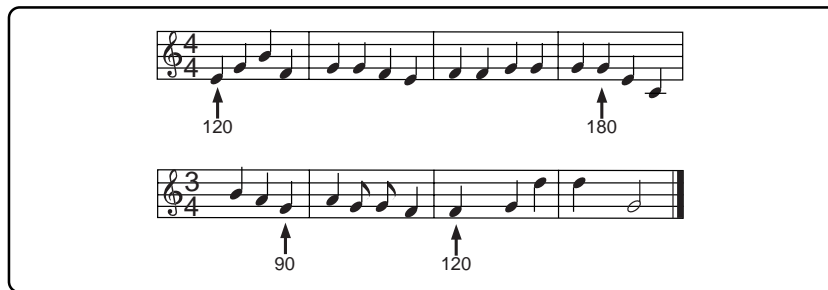

Setting the signature map

- 1) While the recorder is stopped, press the [MENU/ENTER] knob to enter the menu mode. The display now shows the first page of the menu selection screen, where "<< Back" is high lighted initially (selecting "<< Back" returns to the previous screen). You can also return to the previous screen by pressing the [REWIND] key.

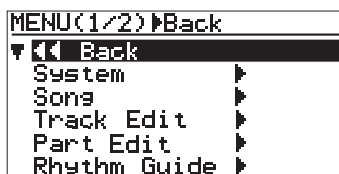

- 2) Rotate the [MENU/ENTER] knob to select "Song", and press the [MENU/ENTER] knob. The display now shows the song editing screen, where "<< Back" is highlighted.

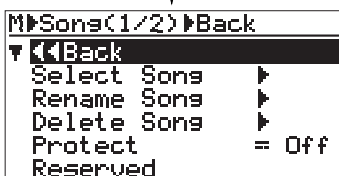
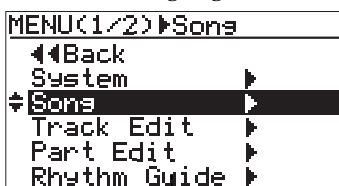

- 3) Rotate the [MENU/ENTER] knob to select "Signature Map" on the second page, and press the [MENU/ENTER] knob.

The display shows the signature map screen on which the current time signature events are listed. Each event specifies the bar number and time signature. By default, "1Bar -> 4/4" and "---Bar -> ---" are listed. In this condition, the song is played in 4/4 from the beginning to the end.

"---Bar -> ---" is used to create a new event.

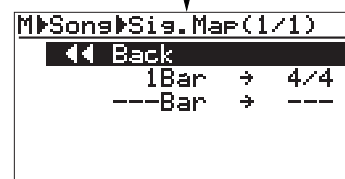
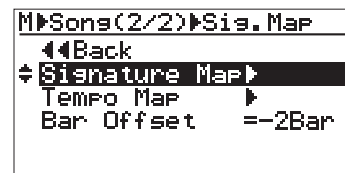

The procedure example below shows how to add the following events to the signature map.

Bar 1 through bar 3:	4/4
Bar 4 through bar 7:	3/4
Bar 8 through bar 11:	4/4
Bar 12 through bar 15:	5/8
Bar 16 through the last bar:	3/4

- 4) Rotate the [MENU/ENTER] knob to select "**---Bar -> ---**", and press the [MENU/ENTER] knob. The display now shows the screen for setting the new time signature event, where "<< Back" is highlighted.

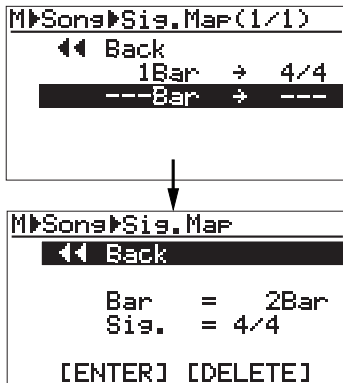

- 5) Rotate the [MENU/ENTER] knob to select "**Bar = 2Bar**", and press the [MENU/ENTER] knob. "2Bar" starts flashing and you can now set the bar number.

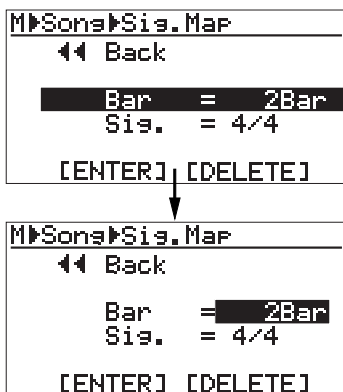

- 6) Rotate the [MENU/ENTER] knob to enter the desired bar number, and press the [MENU/ENTER] knob. In this procedure example, enter "4Bar". The display returns to the previous screen.

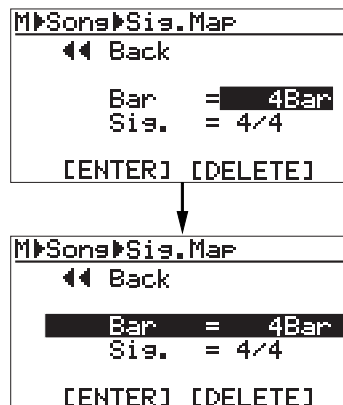

- 7) Rotate the [MENU/ENTER] knob to select "**Sig. = 4/4**", and press the [MENU/ENTER] knob. "4/4" starts flashing and you can now set the time signature.

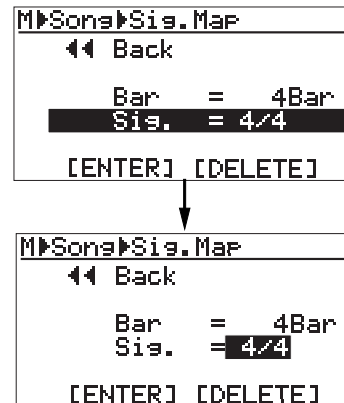

- 8) Rotate the [MENU/ENTER] knob to select the desired time signature, and press the [MENU/ENTER] knob. In this procedure example, enter "3/4". The display returns to the previous screen.

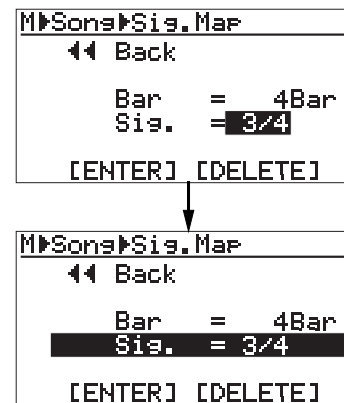

- 9) Rotate the [MENU/ENTER] knob to select "[ENTER]" at the bottom, and press the [MENU/ENTER] knob. The new time signature event is set and the display shows the screen as below. In this condition, the song is played in 4/4 from bar 1 to bar 3 and in 3/4 from bar 4.

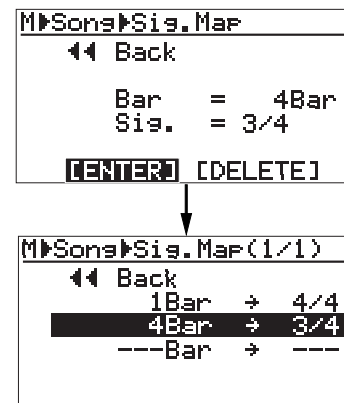

Repeat steps 5 through 9 until creating all necessary events.

• Editing a time signature event

You can edit a time signature event.

- 1) On the time signature map screen, rotate the [MENU/ENTER] knob to select the event you want to edit, and press the [MENU/ENTER] knob. As with the description on the previous page, the display now shows the screen for setting the event. For example, let's select "8Bar -> 4/4".

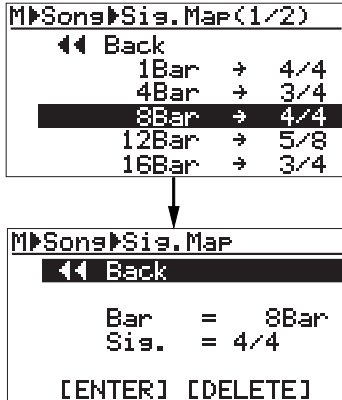

- 2) To change the bar number, rotate the [MENU/ENTER] knob to select "Bar = 8Bar", and press the [MENU/ENTER] knob. To change the time signature, rotate the [MENU/ENTER] knob to select "Sig. = 4/4", and press the [MENU/ENTER] knob. As with the procedure described on the previous page, you can now set the bar number or time signature.

- 3) Rotate the [MENU/ENTER] knob to edit the value, and press the [MENU/ENTER] knob. In this procedure example, enter "10" for the bar number.
- 4) Rotate the [MENU/ENTER] knob to select "[ENTER]" at the bottom, and press the [MENU/ENTER] knob. The editing is confirmed and the display returns to the signature map screen.

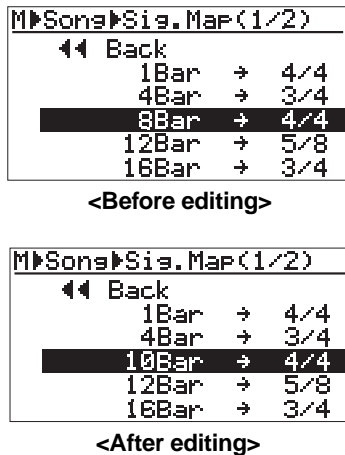

To exit the menu mode, press the [STOP] key,

• Deleting an unnecessary time signature event

You can delete an unnecessary time signature event.

- 1) On the time signature map screen, rotate the [MENU/ENTER] knob to select the event you want to delete, and press the [MENU/ENTER] knob. As with the description on the previous page, the display now shows the screen for setting the event. For example, let's select "8Bar -> 4/4".

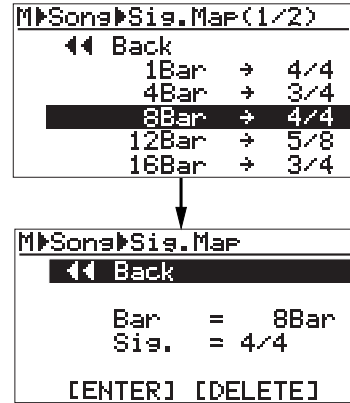

- 2) Rotate the [MENU/ENTER] knob to select "[DELETE]" at the bottom, and press the [MENU/ENTER] knob. The event is immediately deleted and the display returns to the signature map screen.

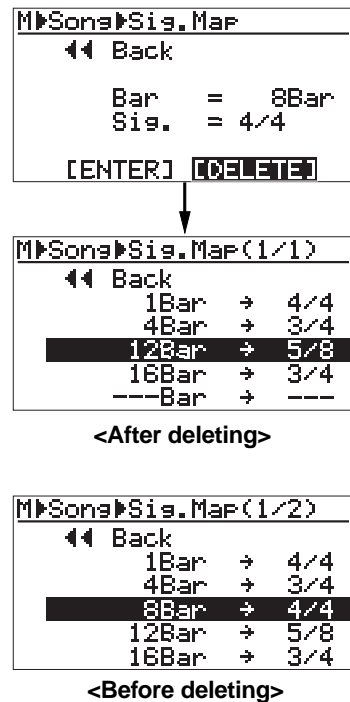

To exit the menu mode, press the [STOP] key,

Editing the bar offset

By default, the bar/beat value at the beginning (ABS ZERO) of the song is set to "bar -2/beat 1". This offset (the bar/beat value at ABS ZERO) is called "bar offset". You can change the default bar offset to the desired value.

- 1) On the second page of the song editing menu screen, highlight "Bar Offset" and press the [MENU/ENTER] knob.
The current offset value (by default, "-2Bar") starts flashing.

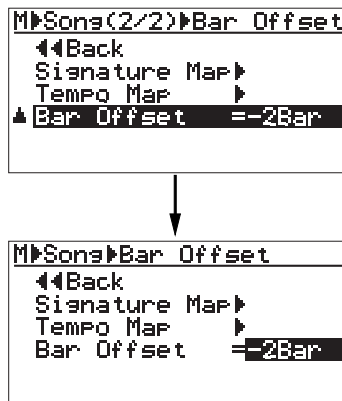

The table below shows the available offset values.

Option	Meaning	Option	Meaning
-8Bar	ABS Zero= bar -8	-3Bar	ABS Zero= bar -3
-7Bar	ABS Zero= bar -7	-2Bar	ABS Zero= bar -2
-6Bar	ABS Zero = bar -6	-1Bar	ABS Zero= bar -1
-5Bar	ABS Zero= bar -5	0Bar	ABS Zero= bar 1
-4Bar	ABS Zero= bar -4		

- 2) Rotate the [MENU/ENTER] knob to select the desired offset value, and press the [MENU/ENTER] knob.
The selected offset value is confirmed, while the display returns to the previous screen.

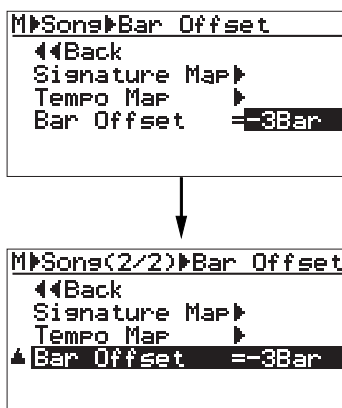

To exit the menu mode, press the [STOP] key,

You can see the bar offset value on the home screen when the recorder is at the beginning of the song (ABS 0).

The screen example below shows the home screen when the bar offset is set to "-4 bars".



The default home screen (bar offset = -2 bars).



The home screen when the bar offset is set to "-4 bars".

Setting the tempo map

After setting the time signature map, you have to create the tempo map by adding the necessary tempo event(s). Like a time signature event, a tempo event specifies the tempo at the tempo changing point. Each tempo specified by a tempo event is effective until the next event appears. For example, you can set the tempo to 120 at the third beat in bar 4, and set to 90 at the second beat in bar 12, etc.

- 1) While the recorder is stopped, press the [MENU/ENTER] knob to enter the menu mode.

The display now shows the first page of the menu selection screen, where "<< Back" is highlighted initially (selecting "<< Back" returns to the previous screen). You can also return to the previous screen by pressing the [REWIND] key.

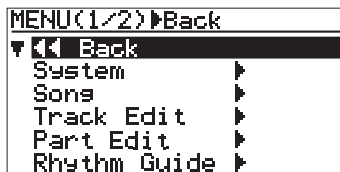

- 2) Rotate the [MENU/ENTER] knob to select "Song", and press the [MENU/ENTER] knob.

The display now shows the song editing screen, where "<< Back" is highlighted.

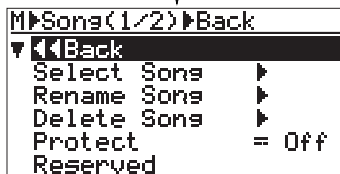
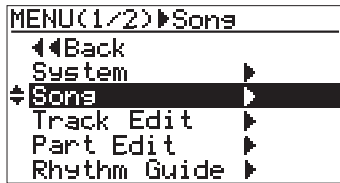

- 3) Rotate the [MENU/ENTER] knob to select "Tempo Map" on the second page, and press the [MENU/ENTER] knob.

The display shows the tempo map screen on which the current tempo events are listed. Each event specifies the bar/beat position and tempo. By default, "1Bar 1-> 120 bpm" and "---Bar -> ---bpm" are listed. In this condition, the song starts in 120 bpm and there is no tempo change. "---Bar-> ---bpm" is used to create a new tempo event.

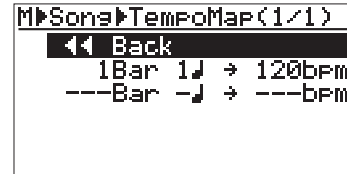
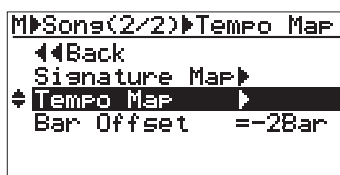

The procedure example below shows how to add the following tempo events to the tempo map.

Bar 1/beat 1:	120 bpm
Bar 4/beat 2:	180 bpm
Bar 8/beat 3:	90 bpm
Bar 12/beat 1:	120 bpm
Bar 16/beat 4:	250 bpm

- 4) Rotate the [MENU/ENTER] knob to select "--Bar -> ---bpm", and press the [MENU/ENTER] knob.

The display now shows the screen for setting the new tempo event, where "<< Back" is highlighted.

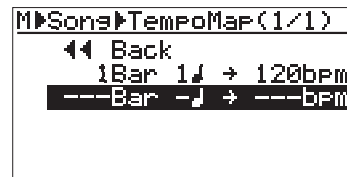

- 5) Rotate the [MENU/ENTER] knob to select "Bar = 2Bar", and press the [MENU/ENTER] knob.

"2Bar" starts flashing and you can now set the bar number. You can enter the bar number between 1 and 999.

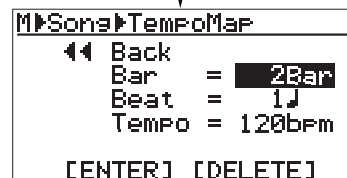
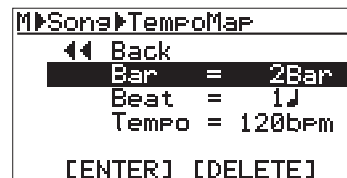

- 6) Rotate the [MENU/ENTER] knob to enter the desired bar number, and press the [MENU/ENTER] knob. In this procedure example, enter "4Bar". The display returns to the previous screen.

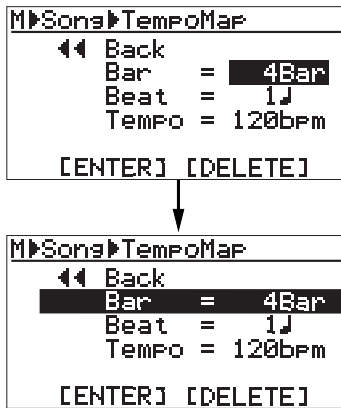

- 7) Rotate the [MENU/ENTER] knob to select "Beat = 1", and press the [MENU/ENTER] knob. "1" starts flashing and you can now set the beat number. You can enter the beat number between 1 and 8.

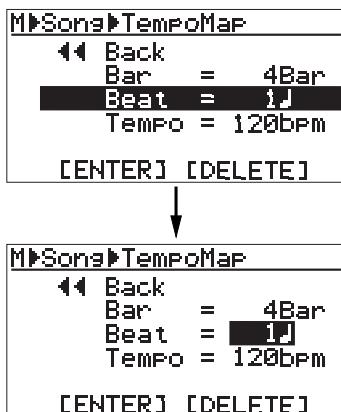

- 8) Rotate the [MENU/ENTER] knob to enter the desired beat number, and press the [MENU/ENTER] knob. In this procedure example, let's enter "2". The display returns to the previous screen.

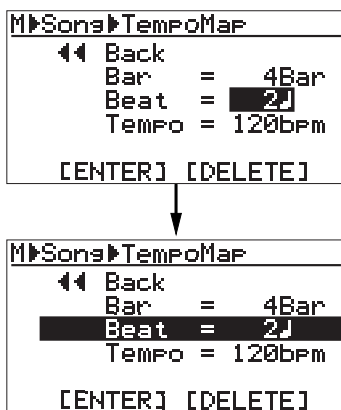

- 9) Rotate the [MENU/ENTER] knob to select "Tempo = 120bpm", and press the [MENU/ENTER] knob.

"120bpm" starts flashing and you can now set the tempo. You can enter the tempo between 30 and 250.

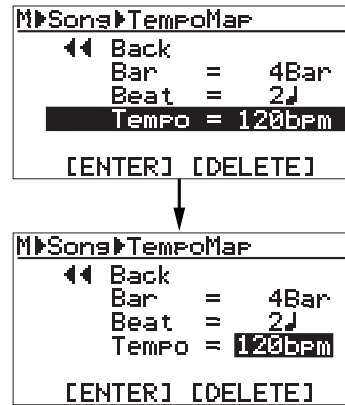

- 10) Rotate the [MENU/ENTER] knob to enter the desired tempo, and press the [MENU/ENTER] knob. In this procedure example, enter "180bpm". The display returns to the previous screen.

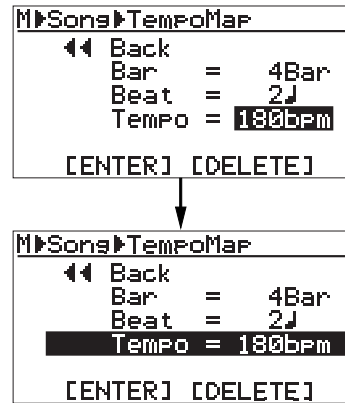

- 11) Rotate the [MENU/ENTER] knob to select "[ENTER]" at the bottom, and press the [MENU/ENTER] knob. The new tempo event is set and the display shows the screen as below. In this condition, the song is played in 120 bpm from the beginning to bar 4/beat 1 and in 180 from bar 4/beat 2 to the end.

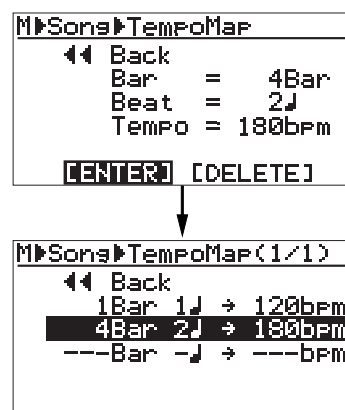

Repeat steps 4 through 11 until creating all necessary tempo events.

• Editing a tempo event

You can edit a tempo event.

- 1) On the tempo map screen, rotate the [MENU/ENTER] knob to select the event you want to edit, and press the [MENU/ENTER] knob.

As with the description on the previous page, the display now shows the screen for setting the event.

For example, let's select "12Bar 1 ↘ 120bpm".

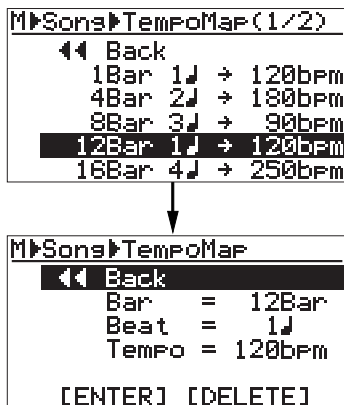

- 2) To change the bar number, rotate the [MENU/ENTER] knob to select "Bar = 12Bar", and press the [MENU/ENTER] knob. To change the beat number, rotate the [MENU/ENTER] knob to select "Beat = 1 ↘", and press the [MENU/ENTER] knob. To change the tempo, rotate the [MENU/ENTER] knob to select "Tempo = 120bpm", and press the [MENU/ENTER] knob.

As with the procedure described on the previous page, you can now set the bar number, beat number or tempo.

- 3) Rotate the [MENU/ENTER] knob to edit the value, and press the [MENU/ENTER] knob.

In this procedure example, let's enter "10" for the bar number.

- 4) Rotate the [MENU/ENTER] knob to select "[ENTER]" at the bottom, and press the [MENU/ENTER] knob.

The editing is confirmed and the display returns to the tempo map screen.

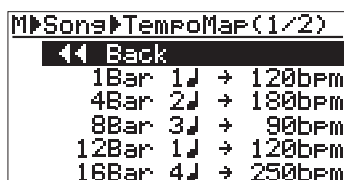

<Before editing>



<After editing>

To exit the menu mode, press the [STOP] key, or select "<< Back" and press the [MENU/ENTER] knob repeatedly.

• Deleting an unnecessary tempo event

You can delete an unnecessary tempo event.

- 1) On the tempo map screen, rotate the [MENU/ENTER] knob to select the event you want to delete, and press the [MENU/ENTER] knob.

As with the description on the previous page, the display now shows the screen for setting the event. For example, let's select "12Bar 1 ↘ 120bpm".

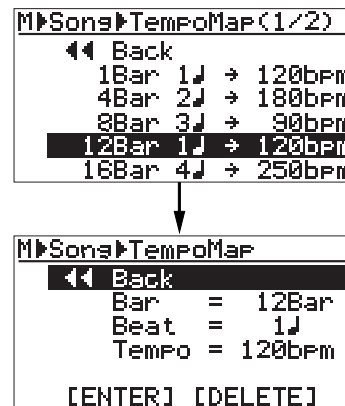

- 2) Rotate the [MENU/ENTER] knob to select "[DELETE]" at the bottom, and press the [MENU/ENTER] knob.

The event is immediately deleted and the display returns to the tempo map screen.

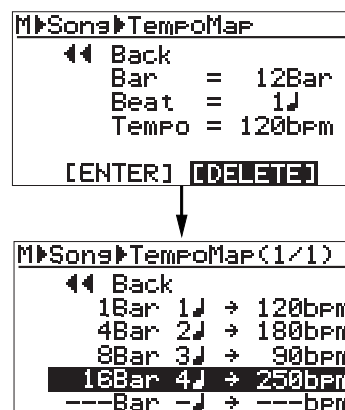

<After deleting>

To exit the menu mode, press the [STOP] key, or select "<< Back" and press the [MENU/ENTER] knob repeatedly.

MIDI synchronization

By connecting the external MIDI devices (such as a sequencer, sound module, computer, etc.) via the [MIDI OUT] connector of the MR-8HD, you can make powerful recording.

For example, by synchronizing a sequencer with the MR-8HD during playback, you can mix down signals (such as a vocal, guitar, etc.) recorded on the MR-8HD tracks and audio from a sound module.

You can synchronize MIDI with the MR-8HD by connecting a MIDI device to the [MIDI OUT] connector on the MR-8HD and sending out MTC (MIDI time code) or MIDI clock (with Song Position Pointer) from the MR-8HD.

Synchronization using MTC

The following describes how to synchronize a sequencer to the MR-8HD which supports MTC (MIDI Time code).

Connection

Connect the [MIDI OUT] connector of the MR-8HD to the [MIDI IN] connector of an external MIDI sequencer using a MIDI cable. (Note that no MIDI cable is supplied with the MR-8HD. Use a commercially available MIDI cable.)

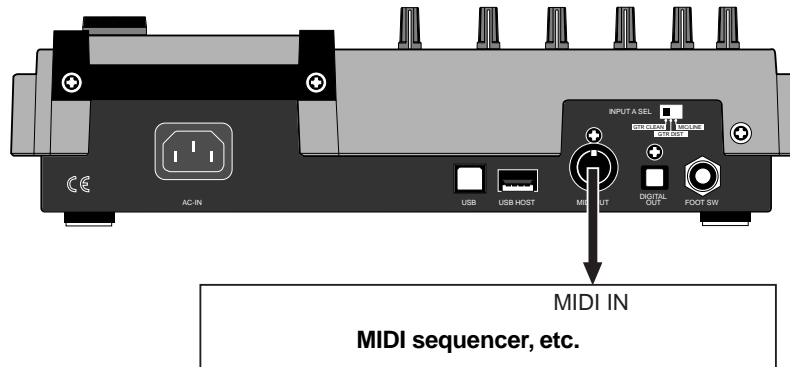

Settings of the MR-8HD and MIDI sequencer

- 1) **Set the "Midi Sync Out" item in the "System" menu of the menu mode to "MTC" and the "MTC Frame Rate" to an appropriate frame rate.**
See "MIDI sync/MTC frame rate settings" described below for details.
- 2) **Enable the external MIDI sequencer to synchronize to MTC.**
See the operation manual of the sequencer for details.
- 3) **Press the [PLAY] key of the MR-8HD to start playback.**
The sequencer automatically starts playback while synchronizing to the MR-8HD.

- 1) **While the recorder is stopped, press the [MENU/ENTER] knob to enter the menu mode.**
The display now shows the first page of the menu selection screen, where "<< Back" is highlighted initially (selecting "<< Back" returns to the previous screen).

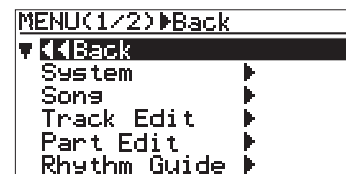

- 2) **Rotate the [MENU/ENTER] knob to select "System", and press the [MENU/ENTER] knob.**
The display now shows the first page of the system menu screen, where "<< BACK" is highlighted initially.

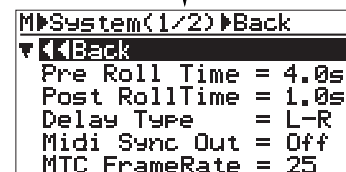
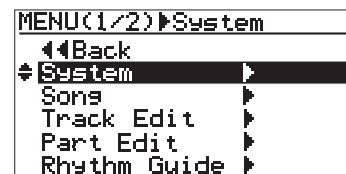

- 3) **Rotate the [MENU/ENTER] knob to select "Midi Sync Out", and press the [MENU/ENTER] knob.**

MIDI sync/MTC frame rate settings

While the MR-8HD is stopped, you can set the reference of MIDI synchronization to "MTC" and the MTC frame rate appropriately to match the sequencer.

<MTC start time>

The MTC from the MR-8HD has one hour offset to the ABS time (the offset value is fixed). Therefore, when you start the MR-8HD from the beginning of a song (ABS ZERO), the MTC starts from "01h00m00s00f".

The current option (the default is "Off") flashes. You can now select the desired option (the available options are Off, CLK and MTC).

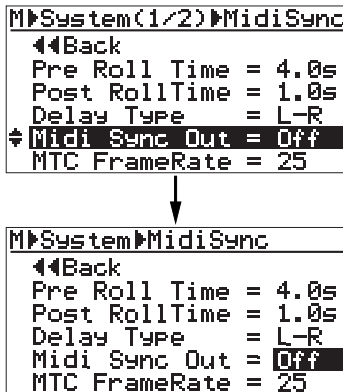

Off	No signal is output from the [MIDI OUT] connector. This is the default.
CLK	MIDI clock with Song Position Pointer is output from the [MIDI OUT] connector.
MTC	MIDI time code is output from the [MIDI OUT] connector.

- 4) Rotate the [MENU/ENTER] knob to select "MTC", and press the [MENU/ENTER] knob.
"Midi Sync Out" is now set to "MTC", while "Midi Sync Out" is highlighted on the screen.

- 5) Rotate the [MENU/ENTER] knob to select "MTC FrameRate", and press the [MENU/ENTER] knob.

The current option (the default is "25") flashes. You can now select the desired frame rate (the options are "24", "25", "30nd" and "30df").

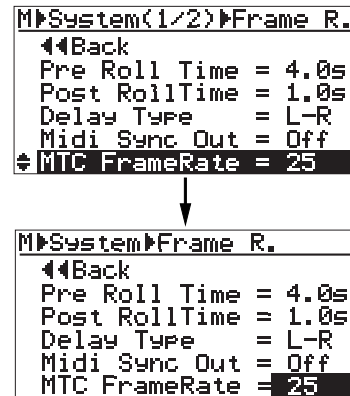

- 6) Rotate the [MENU/ENTER] knob to select the desired frame rate, and press the [MENU/ENTER] knob.
The selected frame rate is now effective, while "MTC FrameRate" is highlighted on the screen.
7. Press the [STOP] key to exit the menu mode.

Synchronization using MIDI clock

The following describes how to synchronize a sequencer to the MR-8HD using MIDI clock. Use this method if the sequencer does not support MTC (MIDI Time code)

<Notes>

- To synchronize a sequencer to the MR-8HD using MIDI clock, you have to make the signature/tempo map in the MR-8HD. The MIDI clock is output based on the signature/tempo map in the MR-8HD. When you record MIDI sounds, synchronize the sequencer to the MIDI clock fed from the MR-8HD.
- Generally, a sequencer supporting MIDI song position pointer as well as MIDI clock can synchronize to the MR-8HD when you start playback of the MR-8HD from the middle of a song. It locates the current song position and chases the MR-8HD. However, note that some sequencer may not synchronize to the MR-8HD.

Connection

As with the connection for MTC synchronization, connect the [MIDI OUT] connector of the MR-8HD to the [MIDI IN] connector of an external MIDI sequencer using a MIDI cable.

Settings of the MR-8HD and MIDI sequencer

- Set the "Midi Sync Out" item in the "System" menu of the menu mode to "Clk".
See "MIDI sync/MTC frame rate settings" described above about how to set.
- Create the signature/tempo map by setting "Signature Map" and "Tempo Map" items in the "Song" menu of the menu mode appropriately.
See "Using the rhythm guide function" on page 76 for details about how to set these items.
- Enable the external MIDI sequencer to synchronize to MIDI clock.
See the operation manual of the sequencer for details.
- Press the [PLAY] key of the MR-8HD to start playback.
The sequencer also starts playback in sync with the MR-8HD.

Data export to a personal computer

This chapter describes how to export song data on tracks 7/8 to a personal computer.

To export the desired song data to a personal computer, you must convert the song data to a stereo WAV file.

You can export the converted (WAV) file to the personal computer and create an audio CD using a CD burning function on the personal computer.

<Notes on USB connection with Mac OS>

When making USB connection with a Macintosh computer, note that only Mac OS X or higher is supported. Do not connect to a Macintosh computer with the earlier version. The song data on the MR-8HD may be damaged.

WAV file conversion

By converting track data recorded on tracks 7/8 (which consists of an L/R pair of mono WAV files) to a stereo WAV file, you can export the data to a personal computer.

The following describes how to convert data on tracks 7/8 (which may be bounced from other tracks or simply recorded in stereo) to a stereo WAV file. See page 92 for details about how to export a converted WAV file to a personal computer.

Two mono WAV files recorded on tracks 7/8 are converted to a stereo WAV file as shown below. (Note that only files recorded on tracks 7/8 can be converted to a stereo WAV file.)



<Note>: If you are going to make conversion when no WAV data exists on tracks 7/8, the error message ("Track 7/8 Empty!") appears and the operation is canceled.

You can convert all track data (from ABS ZERO to REC END) or data of a specified part (between the LOCATE A and LOCATE B points).

<Note>: If you want to convert a part of track data, you have to set the LOCATE A and LOCATE B points in advance.

Enabling the file conversion

You can enable or disable the WAV file conversion function by pressing the [7/8 > STEREO WAV FILE] key.

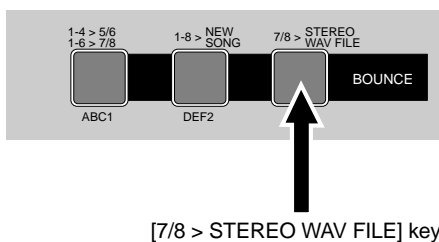

[7/8 > STEREO WAV FILE] key

Each press of the [7/8 > STEREO WAV FILE] key enables or disables the conversion function. The key lights when the conversion function is enabled.

Procedure of file conversion

The following assumes that the song whose track data you want to convert is loaded.

- 1) While the recorder is stopped, press the [7/8 > STEREO WAV FILE] key to enable the file conversion function.

The display shows the "7/8 > STEREO WAV FILE" screen, on which "ABS0-Rec End" is highlighted.

```
7/8>STEREO WAV FILE
-Convert WAV File-
MODE = ABS0-Rec End
NAME = Song04
*****
Enter→REC+ENTER Key
Exit → STOP Key
```

- 2) Press the [MENU/ENTER] knob. "ABS0-Rec End" starts flashing, and you can now select the conversion range between "ABS0-Rec End" and "LOCATE A - LOCATE B".

```
7/8>STEREO WAV FILE
-Convert WAV File-
MODE = ABS0-Rec End
NAME = Song04
*****
SEL → MENU dial
Exit → STOP Key
```

To convert all track data, select "ABS0-Rec End". To convert a specified range, select "LOCATE A - LOCATE B".

- 3) Rotate the [MENU/ENTER] knob to select the conversion range and press the [MENU/ENTER] knob.

The selection is confirmed and the display returns to the previous screen.

"NAME = *****" shows the name for the converted file, and you can enter a desired name. Initially, it shows the name of the source file, therefore, if you do not change the name, the same file name is given.

The following assumes that the file name is not changed. For details about how to edit a name, see "Editing a file name" on the next page. When you convert data in the same song more than once, you have to give a different name for each converted file. See the <Note> on the next page.

- 4) Press the [MENU/ENTER] knob while holding down the [RECORD] key.
The file conversion starts and the percent number on the screen counts up as the conversion progresses.
To cancel the conversion in the middle, press the [STOP] key.

```
7/8>STEREO WAV FILE
-Convert WAV File-
  Converting...
    00 %
Cancel → STOP Key
```

<Note>: If you cancel the conversion in the middle, no file (incomplete file) is created.

When the conversion is completed, the display shows "Completed!".

```
7/8>STEREO WAV FILE
-Convert WAV File-
  Completed
Press ENTER Key
```

- 5) Press the [MENU/ENTER] knob.
The MR-8HD quits the conversion function and the display returns to the home screen.

<Note>: If you convert data with the same name as previously converted data, the following screen appears on the display.

This screen warns you that the WAV file with the same name already exists and asks you to carry out the conversion by overwriting the existing file or cancel the conversion.

```
7/8>STEREO WAV FILE
- Convert WAV File -
Same file name
exists!
Overwrite Prev File?
[NO] [YES]
```

If you carry out the conversion by overwriting the existing file, rotate the [MENU/ENTER] knob to move the cursor to "[YES]", and press the [MENU/ENTER] knob.

If you do not want to overwrite the existing file, rotate the [MENU/ENTER] knob to move the cursor to "[NO]", then press the [MENU/ENTER] knob. The display returns to show the screen for editing the file name, so you can enter a different file name and then carry out the conversion.

If you want to cancel the conversion when the screen above is shown, rotate the [MENU/ENTER] knob to move the cursor to "[NO]" and press the [MENU/ENTER] knob to show the screen for editing the file name, and then press the [7-8>STEREO WAV FILE] key to quit the conversion function.

<Editing a file name>

You can edit a file name by the following procedure.

- 1) After selecting the range of track data to be converted, rotate the [MENU/ENTER] knob to move the cursor to "Name" and press the [MENU/ENTER] knob.

The rightmost character of the file name starts flashing.

You can now start editing.

```
7/8>STEREO WAV FILE
-Convert WAV File-
MODE = ABS0-Rec End
NAME = Sons04
*****
Enter→REC+ENTER Key
Exit → STOP Key
```

```
7/8>STEREO WAV FILE
-Convert WAV File-
MODE = ABS0-Rec End
NAME = Sons04
*****
SEL → MENU dial
Exit → STOP Key
```

Flashing

While the rightmost character is flashing, pressing the [UNDO/REDO]/[DELETE] key repeatedly deletes the current file name.

- 2) Enter a new name using the character entry keys.
Pressing a different character entry key automatically moves the cursor right. If two successive characters are assigned to the same character entry key, rotate the [MENU/ENTER] knob after selecting the first character to move the cursor right.
- 3) After entering a new name, press the [MENU/ENTER] knob.

Then, by pressing the [MENU/ENTER] knob while holding down the [RECORD] key to carry out the WAV file conversion.

Exporting data to a personal computer

The MR-8HD is equipped with the USB port for direct connection to a personal computer using a USB cable.

The USB connection allows you to export the stereo WAV file data, which is converted from a pair of mono WAV files on tracks 7/8, to your computer. The exported data can be played back or edited using a computer's music software application, or used as a source when burning an original audio CD using a CD-R/RW drive. You can also use this exporting capability for backing up data to a personal computer when the remaining space of a hard disk becomes small.

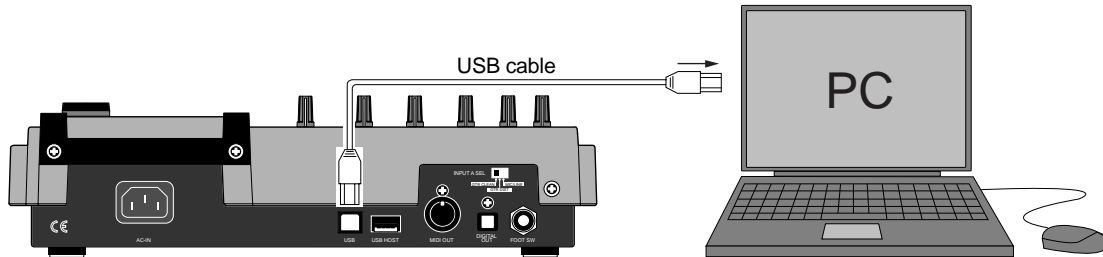

Windows Me/2000/XP machine supporting USB connection

Connection to a personal computer

Connect the [USB] port of the MR-8HD to the USB port of a personal computer using a USB cable, as shown above.

(A USB cable is not supplied with the MR-8HD.)

<Caution>

Use the [USB] port for connection to a personal computer. Do not connect the [USB HOST] port to a personal computer.



<Note>: Only Windows Me, 2000 and XP computers, as well as Macintosh computers with OS X or higher, can be used with the MR-8HD. Other computers cannot be used. Check your computer before making connection.

<Notes on USB connection with Mac OS>

When making USB connection with a Macintosh computer, note that only Mac OS X or higher is supported. Do not connect to a Macintosh computer with the earlier version. The song data on the MR-8HD may be damaged.

Notes on exporting a file

<Note>: You can export only a stereo WAV file which is converted from a pair of mono WAV files on tracks 7/8, as described earlier in "WAV file conversion". A mono WAV file or undo file cannot be exported to a personal computer. See the next page for details about the exportable files.

<Disk protection>

By default, the "disk protect" function which is effective in the USB mode is set to "On". In this condition, the MR-8HD can export data to a personal computer but cannot import data from a computer. This is for protecting the MR-8HD internal hard disk from importing a file from a computer inappropriately and destroying the MR-8HD song data.

You can enable or disable this function, however, we recommend using the MR-8HD by setting it to "On".

If you use the MR-8HD by setting the "disk protect" function to "Off", read "Archiving a song" on page 95 before using. See page 94 for details about how to make the "disk protection" setting.

<Note on backup>

When exporting song data on the hard disk to a personal computer for backup, always export the whole song folder. You cannot export individual track data. See page 95 for details. See "Archiving a song" on page 95 for details about song data backup.

Exporting a WAV file to a personal computer

The following describes the procedure for exporting a WAV file to a Windows ME computer.

<Important note>

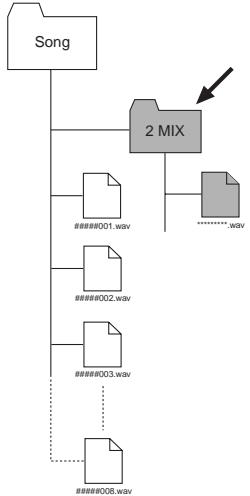

Converted stereo WAV files are located in the "2 MIX" folder in the Song folder, as shown below. So you can export only a stereo WAV file in the "2 MIX" folder (indicated by an arrow).

Note that, if you export a WAV file which is located in a folder other than the "2 MIX" folder, the MR-8HD may malfunction.

1) Turn on the power of the personal computer and the MR-8HD.

2) Press the [MENU/ENTER] knob to enter the menu mode.

The display now shows the first page of the menu selection screen, where "<< Back" is highlighted initially.

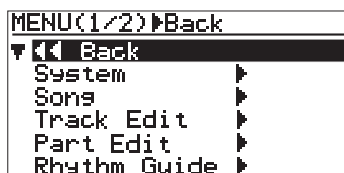

3) Highlight "USB" by rotating the [MENU/ENTER] knob, then press the [MENU/ENTER] knob.

The display shows the USB menu screen.

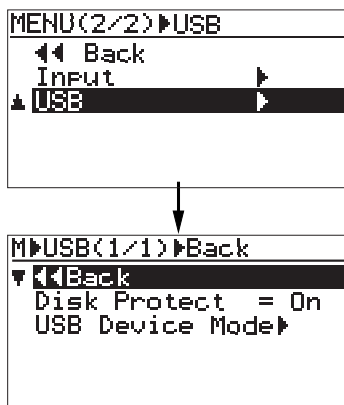

4) Rotate the [MENU/ENTER] knob to move the cursor to "USB Device Mode", and press the [MENU/ENTER] knob.

The MR-8HD enters the USB mode and the display shows the screen as below.

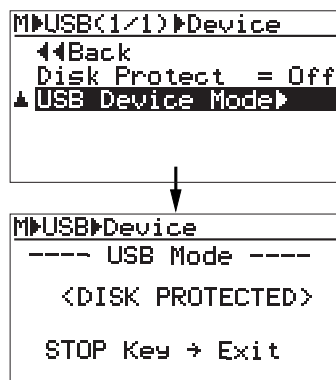

<Note>: By default, the disk protect function is enabled. In this condition, when the MR-8HD enters the USB mode, "<DISK PROTECTED>" is shown in the USB screen, as above.

<Note>: While the MR-8HD is in the USB mode, all keys except the [STOP] key are ineffective. Pressing the [STOP] key exits the USB mode.

5) Connect the MR-8HD to a personal computer using a USB cable.

6) Open "My computer" on the computer screen. You see the "Removable disk" drive added on the computer. The first time you connect the MR-8HD, the device driver is installed automatically.

7) Open the added Removable disk drive, and select the stereo WAV file in the desired song folder, then copy to the computer.

When you open the added Removable disk drive, the contents of the MR-8HD hard disk are shown, in which you can see all the song folders.

Open the "2 MIX" folder in the desired song folder, and select the stereo WAV file, then copy it to the computer.

While copying data, the [RECORD] key indicator of the MR-8HD lights (flashes), showing that the hard disk is being accessed. When data copy completes, the indicator turns off.

<Note>: After copying a WAV file in the folder to a computer, the original file remains. However, if you execute "move to another folder", the original file on the disk is lost.

8) When the data export completes, disconnect the MR-8HD from the personal computer.

<Note>: To disconnect the MR-8HD from the personal computer after completing the data export, make sure that the [RECORD] key indicator is not lit, and follow the procedure for hardware disconnection of Windows.

9) Press the [STOP] key to exit the menu mode.

Protecting the hard disk

The MR-8HD internal hard disk is protected by default.

The protection is effective only in the USB mode in which the MR-8HD is used with a personal computer. You can make the hard disk “read only” (protected) or “read/write enabled” (unprotected). The default is “read only”.

As mentioned earlier in “Disk protection” on page 92, if you transfer song data from a computer to the MR-8HD improperly, the data may be damaged. To avoid such an accident, we recommended enabling hard disk protection. To disabling the disk protection, follow the procedure below.

- 1) While the recorder is stopped, press the [MENU/ENTER] knob to enter the menu mode. The display now shows the first page of the menu selection screen, where "<< Back" is highlighted initially.

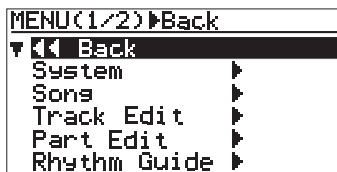

- 2) Rotate the [MENU/ENTER] knob to select “USB” on the second page, and press the [MENU/ENTER] knob. The display now shows the USB menu screen, where “<<Back” is highlighted. Selecting “<<Back” returns to the previous screen. You can also return to the previous screen by pressing the [REWIND] key.

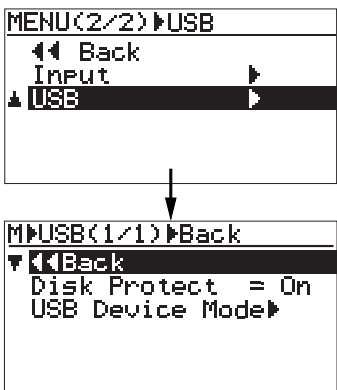

- 3) Rotate the [MENU/ENTER] knob to highlight “Disk Protect”, and press the [MENU/ENTER] knob. The current setting (the default is “On”) flashes.

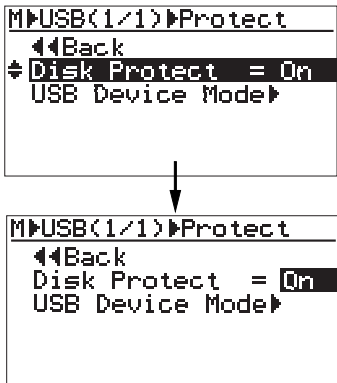

- 4) Rotate the [MENU/ENTER] knob to select “Off”, and press the [MENU/ENTER] knob. The selection is confirmed and the display returns to the previous screen.

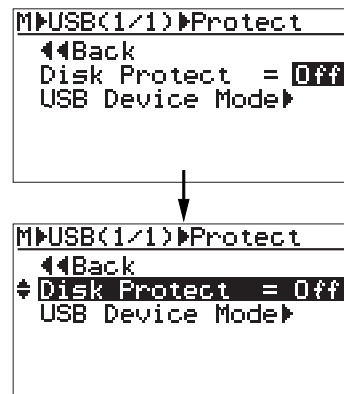

Off	The disk is “read/write enabled” (unprotected). You can transfer data between the MR-8HD and a computer in both ways.
On	The disk is “read only” (protected). You can transfer data only from the MR-8HD to a computer (default setting).

- 5) Press the [STOP] key to exit the menu mode.

<Note>: When you enter the USB mode while the disk protection is disabled, the screen as below is shown. In this condition, the hard disk is “read/write enabled” and you can bi-directionally transfer song data between a computer and the MR-8HD.

Archiving a song

You can archive song data recorded by the MR-8HD by using either of the following methods.

(1) Using the WAV Manager supplied by Fostex

The WAV Manager converts each track data to a single mono file. Data is compressed so you can save the file in small size to a personal computer. This method is useful for exporting data to a PC software application for multitrack recording.

For details about how to use the WAV Manager, see the owner's manual supplied with the WAV Manager. You can download the WAV Manager from Fostex web site (<http://www.fostex.co.jp>).

(2) Using drag & drop technique

You can copy a song folder using drag & drop technique. This method allows saving all data in the folder (including the history data, etc.).

• Exporting data to a personal computer

- 1) **Connect the MR-8HD to a personal computer via USB, and open the root folder.**
You can copy each song folder in the root folder to the personal computer.
- 2) **Copy a desired song folder to the personal computer using drag & drop technique.**
- 3) **After making copy, exit the USB mode.**

<Note>: When drag & drop the folder on your personal computer, use the "copy" function. If you use the "move" function, not only the song on the MR-8HD is deleted but also other songs on the MR-8HD may be destroyed. We recommend to enable the disk protection (the default is "enabled") when executing data copy.

Using this method, you can also copy the hidden folder which includes hidden files "deleted" by the MR-8HD song management operation. Copied hidden files can be used as a normal song files by turning off the hidden attribute by the computer.

<Note>: If you cannot see the hidden folder, consult the manual of your personal computer.

• Importing data from a personal computer

When importing data from a personal computer to the MR-8HD, there is the danger that the MR-8HD file system may be destroyed. Especially, deleting or adding files many times may cause the fragmentation of FAT32, resulting in sound jump caused by performance deterioration. Therefore, before loading data from a personal computer to the MR-8HD, save all necessary folders to the personal computer and format the MR-8HD hard disk.

- 1) **Format the MR-8HD internal hard disk (see page 124).**
- 2) **Disable the disk protection (see page 94).**
- 3) **Connect the MR-8HD to a personal computer via USB (see page 93).**
- 4) **Copy the desired song folder on the personal computer to the root folder of the MR-8HD hard disk.**

<Note>: Do not use "move" operation, as with saving data to a computer.

- 5) **Repeat step 4) as many times as required.**

<Note>: Usually, the song order follows the copied order. However, it may be different depending on a computer OS.

- 6) **After making copy of all necessary folders, exit the USB mode.**

Song management

This chapter explains the following five operation procedures for song management.

- 1) **Selecting the desired song.**
- 2) **Editing a song name.**
- 3) **Deleting an unnecessary song.**
- 4) **Protecting a song.**

<Notes>

While a menu screen is shown, you can go up the menu screen level or directly exit the menu mode by the following operations.

- (1) **Select “<< Back” on a menu screen and press the [MENU/ENTER] knob.**
The display returns to the previous (upper level) screen. Repeating this operation finally exits the menu mode.
- (2) **Press the [REWIND] key.**
The display returns to the previous (upper level) screen. Repeating this operation finally exits the menu mode.
- (3) **Press the [STOP] key.**
The menu mode exits and the display shows the home screen.

Selecting the desired song

The following describes how to select the desired song from the disk when more than one song is created on the disk. You can also create a new song by the similar procedure. See "Basic operations" (page 31) for details about how to create a new song.

- 1) **While the recorder is stopped, press the [MENU/ENTER] knob to enter the menu mode.**

The display now shows the first page of the menu selection screen, where "<< Back" is highlighted initially (selecting "<< Back" returns to the previous screen).

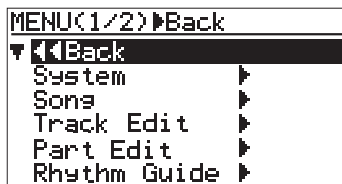

- 2) **Rotate the [MENU/ENTER] knob to select "Song", and press the [MENU/ENTER] knob.**

The display now shows the song menu screen, where "<< Back" is highlighted.

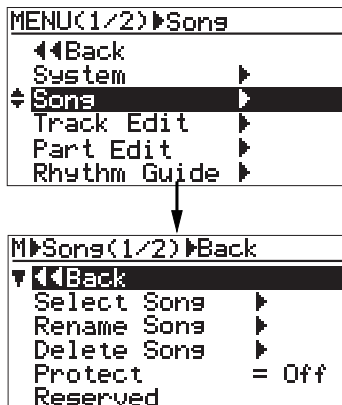

- 3) **Rotate the [MENU/ENTER] knob to select "Select Song >" and press the [MENU/ENTER] knob.**

The display now shows the song list screen.

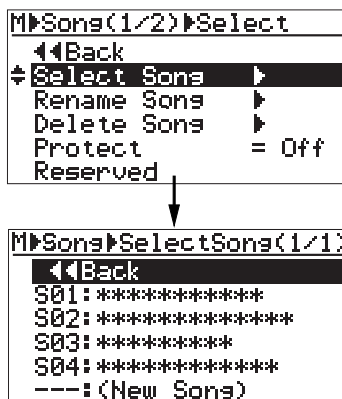

The screen example above shows that four songs are currently created on the hard disk. The song list is shown on a single page.

When more songs are created, the song list screen has more than one page, and you can scroll the list by rotating the [MENU/ENTER] knob.

"---:(New Song)" at the bottom of the screen is used when you create a new song.

- 4) **Rotate the [MENU/ENTER] knob to select the desired song number/song name, and press the [MENU/ENTER] knob.**

The display returns to the song menu screen, where "Select Song >" is highlighted.

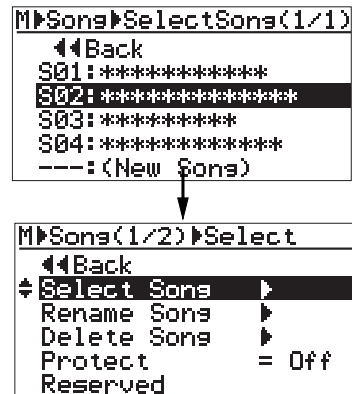

- 5) **Press the [STOP] key to exit the menu mode.**

The display shows the home screen of the selected song.

Editing a song name

You can edit a current song name save the edited song name. Only the current song can be edited.

- 1) Load the desired song of which you are going to edit the song name.

- 2) While the recorder is stopped, press the [MENU/ENTER] knob to enter the menu mode. The display now shows the first page of the menu selection screen, where "<< Back" is highlighted initially (selecting "<< Back" returns to the previous screen).

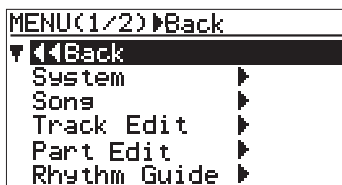

- 3) Rotate the [MENU/ENTER] knob to select "Song >", and press the [MENU/ENTER] knob. The display now shows the song menu screen, where "<< Back" is highlighted.

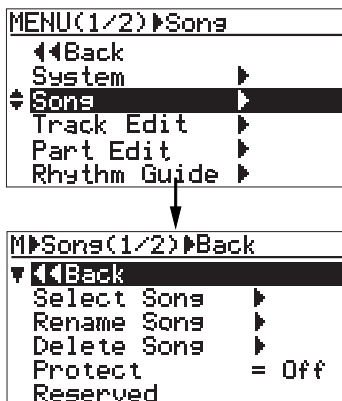

- 4) Rotate the [MENU/ENTER] knob to select "Rename Song >", then press the [MENU/ENTER] knob. The display now shows the screen for song name editing of the current song, on which the rightmost character of song name flashes.

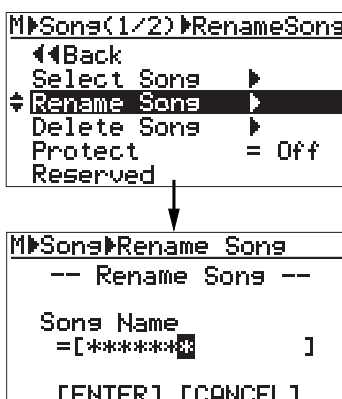

- 5) Use the character entry keys to enter the desired character to the flashing point.

You can move the cursor (flashing point) by rotating the [MENU/ENTER] knob (or by pressing another character entry key).

<Character entry keys>

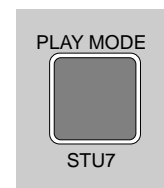

Some keys on the MR-8HD top panel act as character entry keys in the menu mode. For example, the [PLAY MODE] key (shown on the left) can be used to enter S, T, U, s, t, u and 7. Each press of a character entry key switches the character to be entered from among those assigned to the key.

<[DELETE] key>

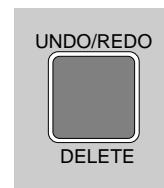

Pressing the [UNDO/REDO - DELETE] key deletes the character at the flashing point. By pressing this key repeatedly, you can delete all characters under the flashing point.

<Note>: If you enter the same name as an existing song or do not enter a name in step 5 and press the [MENU/ENTER] knob in step 6 below, the display shows "Illegal Song Name!" and returns to the song name editing screen.

- 6) After entering the name, press the [MENU/ENTER] knob.

The cursor moves to "[ENTER]" at the bottom of the screen. To cancel the operation, use the [MENU/ENTER] knob to highlight "[CANCEL]" and press the [MENU/ENTER] knob.

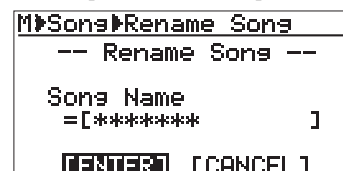

- 7) Press the [MENU/ENTER] knob again. The edited name is stored and the display returns to the song menu screen, where "Rename Song >" is highlighted.

- 8) Press the [STOP] key to exit the menu mode. The MR-8HD exits the menu mode and the display shows the home screen where the edited song name is displayed.

Deleting an unnecessary song

You can delete a song created on the hard disk.

<Notes>

- You cannot delete a song which is protected. To delete such a song, release the protection of the song first (see the next page).
- A deleted song file still remains as a "hidden file" on the hard disk. So deleting a song file does not increase the remaining (recordable) space of the hard disk.
- You can export a "hidden file" to your personal computer via USB connection and use it on the computer (see page 95).

- 1) While the recorder is stopped, press the [MENU/ENTER] knob to enter the menu mode.

The display now shows the first page of the menu selection screen, where "<< Back" is highlighted initially (selecting "<< Back" returns to the previous screen).

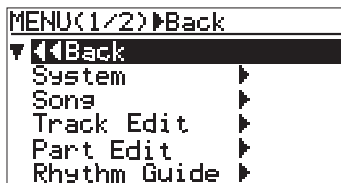

- 2) Rotate the [MENU/ENTER] knob to select "Song", and press the [MENU/ENTER] knob.

The display now shows the song menu screen, where "<< Back" is highlighted.

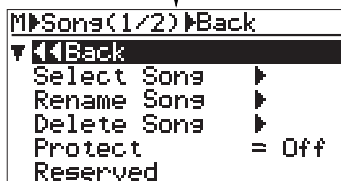
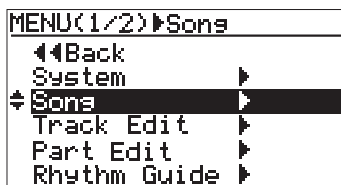

- 3) Rotate the [MENU/ENTER] knob to select "Delete Song", and press the [MENU/ENTER] knob.

The display now shows the list of songs created on the hard disk, from which you select a song to be deleted. In the screen example below, five songs are created so the list has only one page. (If more than five songs are created, the list has more than one page.)

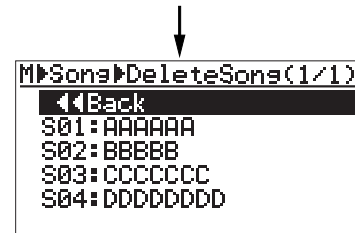
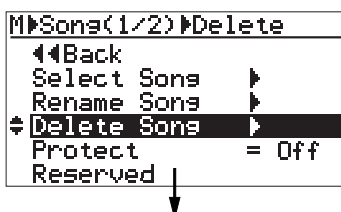

- 4) Rotate the [MENU/ENTER] knob to select a song to be deleted, and press the [MENU/ENTER] knob.

The display shows warning and confirmation for deleting the song.

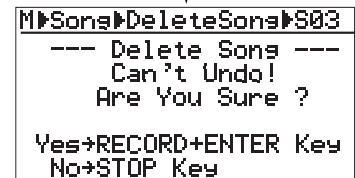
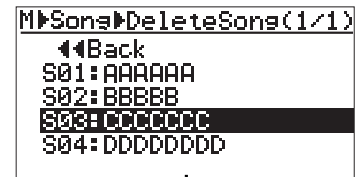

- 5) Press the [MENU/ENTER] knob while holding down the [RECORD] key.

The selected song is deleted, and the display returns to the song list screen.

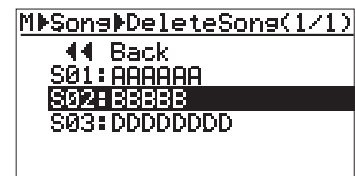

Any song number greater than the song number of the deleted song is moved up.

In the screen example above, after Song 03 is deleted, ex-Song 04 is moved up to Song 03 and ex-Song 05 is moved up to Song 04.

- 6) Press the [STOP] key to exit the menu mode.

In the example above, the display now shows the home screen of new Song 03 (ex-Song 04).

If you delete all songs on the hard disk by repeating the procedure above, "(New Song)" is shown. Then, create a new song (see page 31).



Protecting a song

You can protect a song to prevent an accidental erasure. The protection can be released whenever you want. To keep a recorded song safely, we recommend protecting it. You can make protection setting only for the current song.

- 1) Load the song you want to protect.
- 2) While the recorder is stopped, press the [MENU/ENTER] knob to enter the menu mode. The display now shows the first page of the menu selection screen, where "<< Back" is highlighted initially (selecting "<< Back" returns to the previous screen).

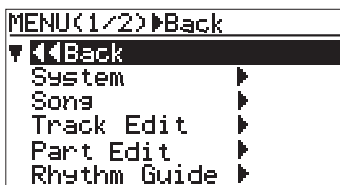

- 3) Rotate the [MENU/ENTER] knob to select "Song", and press the [MENU/ENTER] knob. The display now shows the song menu screen, where "<< Back" is highlighted.

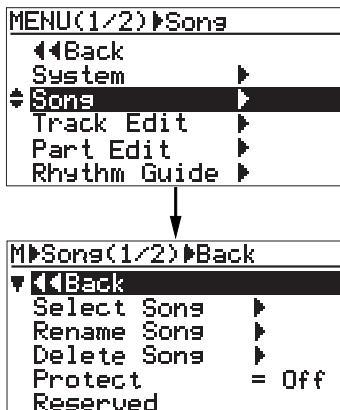

- 4) Rotate the [MENU/ENTER] knob to select "Protect", then press the [MENU/ENTER] knob. The current option ("On" or "Off") flashes. The default option is "Off".

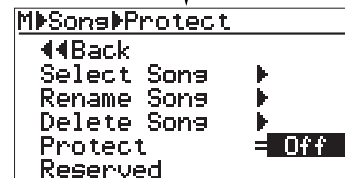
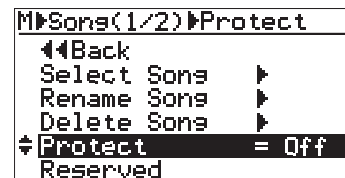

- 5) Rotate the [MENU/ENTER] knob to select "On", and press the [MENU/ENTER] knob. The current song is now protected. The display returns to the previous screen.

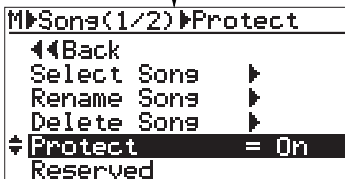
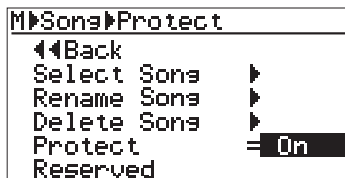

To release the protection, carry out the same procedure above but select "Off" and press the [MENU/ENTER] knob in step 5.

<Note>: You cannot make recording or editing to a protected song. If you want to make recording or editing to a protected song, you must release the protection first.

<Note>: When you set the protection to "On", all the recording-related keys, such as the [REC SELECT] and [BOUNCE] keys, are turned off.

6) Press the [STOP] key to exit the menu mode.

<Tips>

When the protected song is loaded, "🔒" is shown in the upper left corner of the Home screen (indicated by the arrow in the screen example below).

When this icon is shown, you cannot make recording or edit the song.



Track editing

This chapter describes how to edit whole data of a selected (mono or stereo) track. Track editing does not consume the hard disk space. Therefore, the remaining space of the disk does not change by executing track editing.

<Undo/redo of track editing>

By pressing the [UNDO/REDO] key after executing track editing, you can undo the editing. By pressing the [UNDO/REDO] key after the undo operation, you can return the track(s) to the condition after being edited.



<Notes>

Also note that, if you carry out any of the following after editing, you cannot undo the editing anymore.

1. Making new recording
2. Making new editing
3. Turning off the power
4. Loading another song

<Notes>

While a menu screen is shown, you can go up the menu screen level or directly exit the menu mode by the following operations.

- (1) **Select “<< Back” on a menu screen and press the [MENU/ENTER] knob.**
The display returns to the previous (upper level) screen. Repeating this operation finally exits the menu mode.
- (2) **Press the [REWIND] key.**
The display returns to the previous (upper level) screen. Repeating this operation finally exits the menu mode.
- (3) **Press the [STOP] key.**
The menu mode exits and the display shows the home screen.

Erasing track data

You can erase whole data (from ABS ZERO to REC END) of the desired track(s) of the song currently loaded.



<Note>: You cannot erase track data of a song protected.

- 1) Load the song you want to edit.
- 2) While the recorder is stopped, press the [MENU/ENTER] knob to enter the menu mode. The display now shows the first page of the menu selection screen, where "<< Back" is highlighted initially (selecting "<< Back" returns to the previous screen).

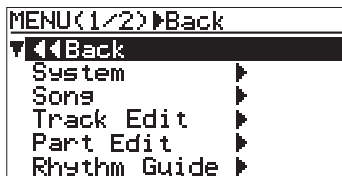

- 3) Rotate the [MENU/ENTER] knob to select "Track Edit >", and press the [MENU/ENTER] knob. The display now shows the track edit menu screen, where "<< Back" is highlighted.

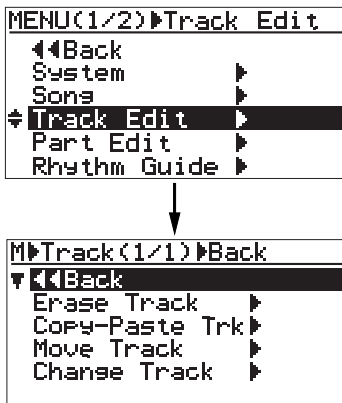

- 4) Rotate the [MENU/ENTER] knob to select "Erase Track >", and press the [MENU/ENTER] knob. The display now shows the screen for selecting the track(s) to be erased.

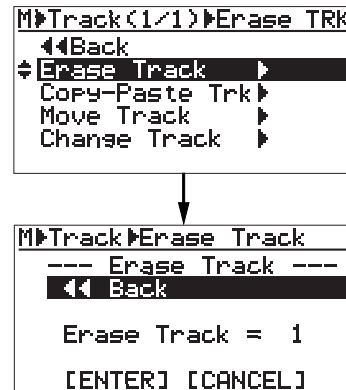

- 5) Rotate the [MENU/ENTER] knob to select "Erase Track = *", and press the [MENU/ENTER] knob. The currently selected option flashes and you can now select the desired option by rotating the [MENU/ENTER] knob. The available options are:

- 1 through 8 (mono track)
- 1/2, 3/4, 5/6 and 7/8 (stereo tracks)

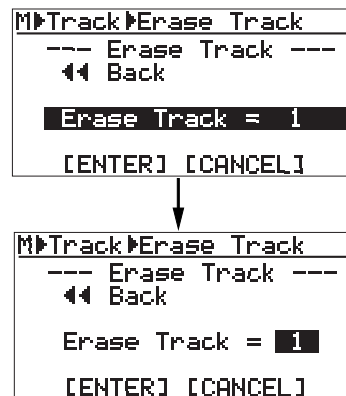

- 6) Rotate the [MENU/ENTER] knob to select the desired option, and press the [MENU/ENTER] knob. "Erase Track = *" is now highlighted on the screen.
- 7) Rotate the [MENU/ENTER] knob to move the cursor to "[ENTER]" on the screen, and press the [MENU/ENTER] knob. The display shows "Please Wait", immediately followed by "Completed" when the MR-8HD completes erasing.

<Note>: If you want to cancel the erase operation, move the cursor to "[CANCEL]" on the screen, and press the [MENU/ENTER] knob.

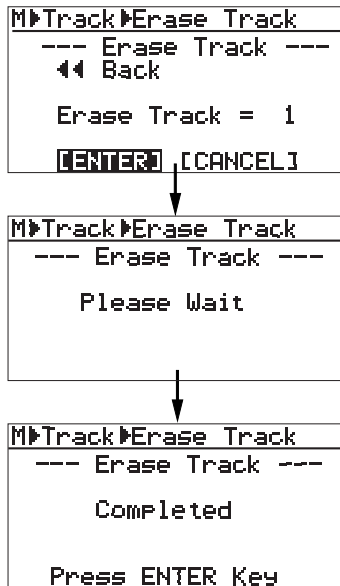

- 8) Press the [MENU/ENTER] knob.
The display now returns to the track edit menu screen, where "Erase Track >" is highlighted.
- 9) Press the [STOP] key to exit the menu mode.

<Note>: If you are not satisfied with the result, press the [UNDO/REDO] key to undo the operation (see page 103).

Copying/pasting track data

You can copy whole data (from ABS ZERO to REC END) of the desired track(s) of the song currently loaded and paste it to the other desired track(s). The data on the source track(s) still remains after the copy/paste operation. Copy/paste operation can be done within the currently loaded song.

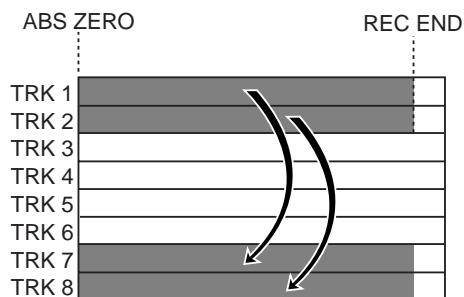

<Note>: You cannot copy/paste track data of a song protected. Release the protection before copying/pasting track data.

- 1) Load the song you want to edit.
- 2) While the recorder is stopped, press the [MENU/ENTER] knob to enter the menu mode. The display now shows the first page of the menu selection screen, where "<< Back" is highlighted initially (selecting "<< Back" returns to the previous screen).

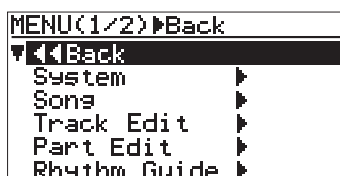

- 3) Rotate the [MENU/ENTER] knob to select "Track Edit >", and press the [MENU/ENTER] knob.
The display now shows the track edit menu screen, where "<< Back" is highlighted.

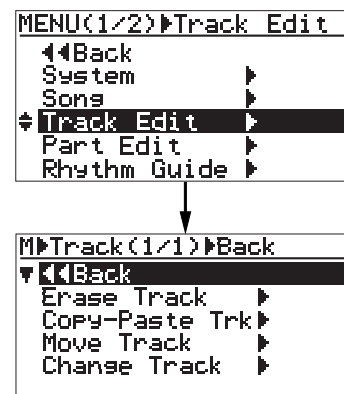

- 4) Rotate the [MENU/ENTER] knob to select "Copy-Paste Track >", and press the [MENU/ENTER] knob.
The display now shows the screen for selecting the source track(s) and destination track(s) of copy/paste operation. "Source Track" selects the copy source track(s), while "Dest. Track" selects the paste destination track(s).

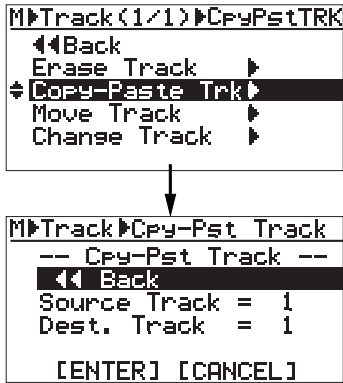

- 5) Rotate the [MENU/ENTER] knob to select "Source Track = *", and press the [MENU/ENTER] knob.

You can now select the desired copy source track(s) by rotating the [MENU/ENTER] knob. The available options are:

- 1 through 8 (mono track)
- 1/2, 3/4, 5/6 and 7/8 (stereo tracks)

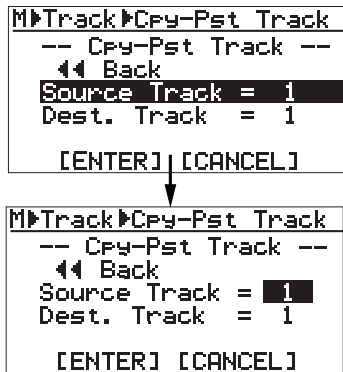

- 6) Rotate the [MENU/ENTER] knob to select the source track(s) to be copied, and press the [MENU/ENTER] knob.

You can now select the desired copy destination track(s)

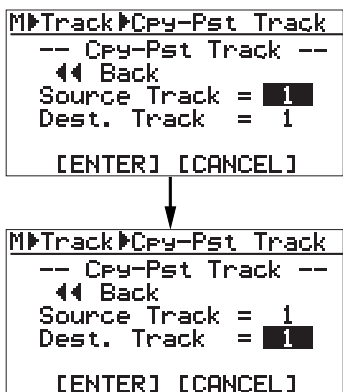

You can select the same number of tracks as the copy source track(s). For example, if you select a mono track for the source, you can only select a mono track for the destination.

<Note>: You cannot select the same track(s) for the copy source and destination.

- 7) Rotate the [MENU/ENTER] knob to select the destination track(s), and press the [MENU/ENTER] knob.

"Dest. Track = *" is now highlighted on the screen.

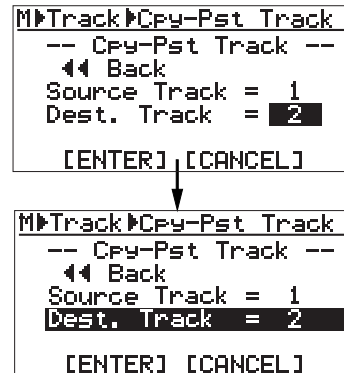

- 8) Rotate the [MENU/ENTER] knob to move the cursor to "ENTER" at the bottom of the screen, then press the [MENU/ENTER] knob.

The display shows "Please Wait", immediately followed by "Completed" when the MR-8HD completes the copy/paste operation.

<Note>: If you want to cancel the copy/paste operation, move the cursor to "[CANCEL]" on the screen, and press the [MENU/ENTER] knob.

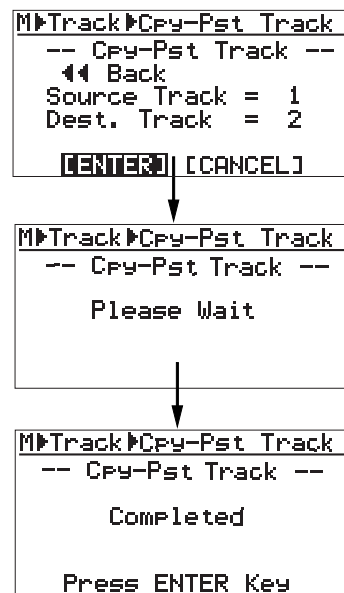

<Note>: If a destination track has recorded data, pasting the copied data overwrites the previous data.

- 9) Press the [MENU/ENTER] knob. The display now returns to the track edit menu screen, where "Copy-Paste Trk >" is highlighted.
- 10) Press the [STOP] key to exit the menu mode.

<Note>: If you are not satisfied with the result, press the [UNDO/REDO] key to undo the operation (see page 103).

Moving track data

You can move whole data (from ABS ZERO to REC END) of the desired track(s) to the other desired track(s). After the data is moved, the original track(s) is(are) silent. You can only move track data within the current song.

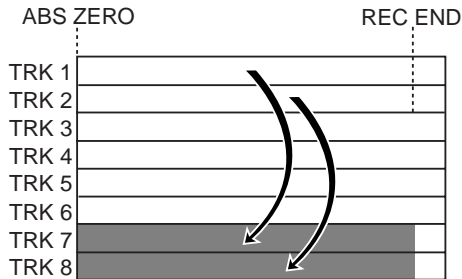

<Note>: You cannot move track data of a song protected. Release the protection before moving track data.

- 1) Load the song you want to edit.
- 2) While the recorder is stopped, press the [MENU/ENTER] knob to enter the menu mode. The display now shows the first page of the menu selection screen, where "<< Back" is highlighted initially (selecting "<< Back" returns to the previous screen).

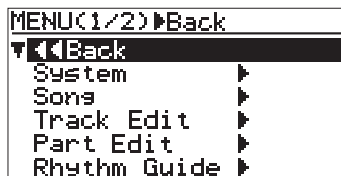

- 3) Rotate the [MENU/ENTER] knob to select "Track Edit >", and press the [MENU/ENTER] knob. The display now shows the track edit menu screen, where "<< Back" is highlighted.

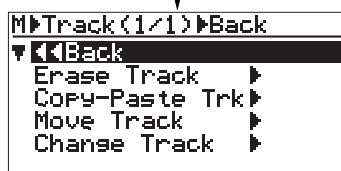
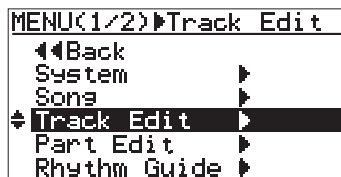

- 4) Rotate the [MENU/ENTER] knob to select "Move Track >", and press the [MENU/ENTER] knob. The display now shows the screen for selecting the source track(s) and destination track(s) of the move operation. "Source Track" selects the move source track(s), while "Dest. Track" selects the move destination track(s).

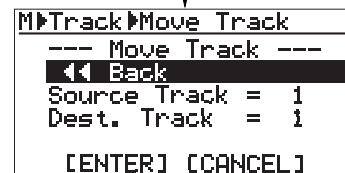
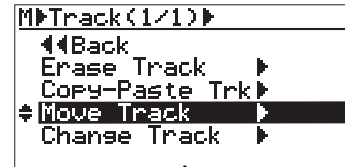

- 5) Rotate the [MENU/ENTER] knob to select "Source Track = *", and press the [MENU/ENTER] knob.

You can now select the desired move source track(s) by rotating the [MENU/ENTER] knob. The available options are:

- 1 through 8 (mono track)
- 1/2, 3/4, 5/6 and 7/8 (stereo tracks)

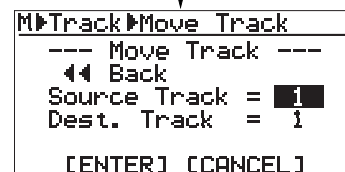
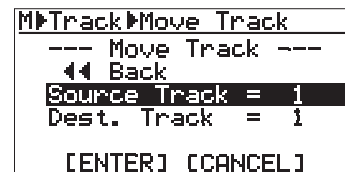

- 6) Rotate the [MENU/ENTER] knob to select source track(s), and press the [MENU/ENTER] knob. You can now select the desired destination track(s).

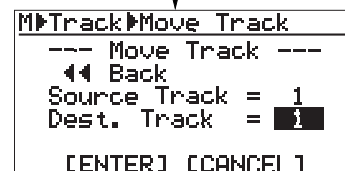
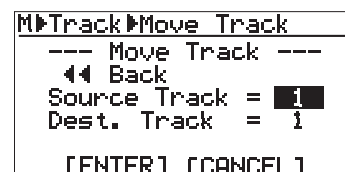

You can select the same number of tracks as the move source track(s). For example, if you select a mono track for the move source, you can only select a mono for the move destination.

<Note>: You cannot select the same track(s) for the move source and destination.

- 7) Rotate the [MENU/ENTER] knob to select destination track(s), and press the [MENU/ENTER] knob. "Dest. Track = *" is now highlighted on the screen.

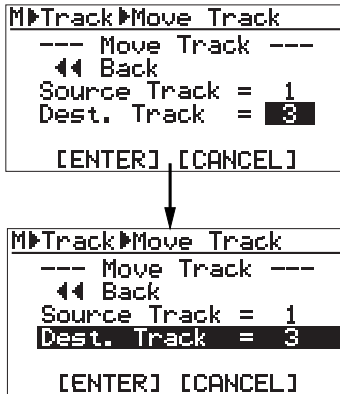

- 8) Rotate the [MENU/ENTER] knob to move the cursor to "[ENTER]" on the screen, and press the [MENU/ENTER] knob. The display shows "Please Wait", immediately followed by "Completed" when the MR-8HD completes the move operation.

<Note>: If you want to cancel the move operation, move the cursor to "[CANCEL]" on the screen, and press the [MENU/ENTER] knob.

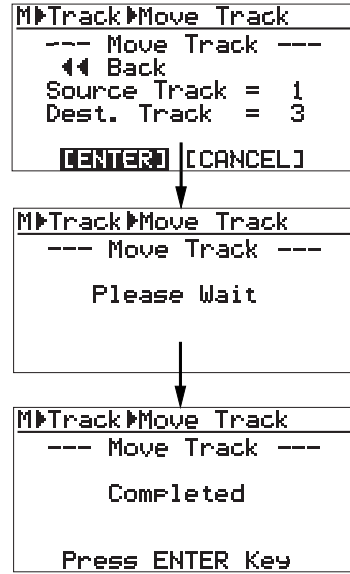

<Note>: If a destination track has recorded data, moving data overwrites the previous data.

- 9) Press the [MENU/ENTER] knob. The display now returns to the track edit menu screen, where "Move Track >" is highlighted.
- 10) Press the [STOP] key to exit the menu mode.

<Note>: If you are not satisfied with the result, press the [UNDO/REDO] key to undo the operation (see page 103).

Exchanging whole track data

You can exchange whole data (from ABS ZERO to REC END) between the desired track(s).

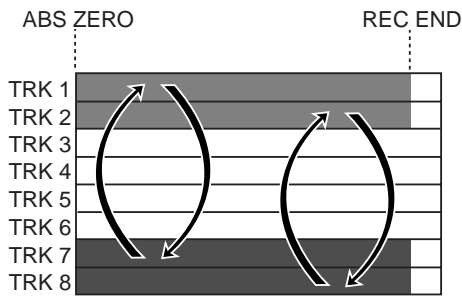

<Note>: You cannot exchange track data of a song protected. Release the protection before exchanging track data.

- 1) Load the song you want to edit.
- 2) While the recorder is stopped, press the [MENU/ENTER] knob to enter the menu mode. The display now shows the first page of the menu selection screen, where "<< Back" is highlighted initially (selecting "<< Back" returns to the previous screen).

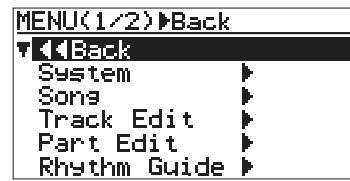

- 3) Rotate the [MENU/ENTER] knob to select "Track Edit >", and press the [MENU/ENTER] knob. The display now shows the track edit menu screen, where "<< Back" is highlighted.

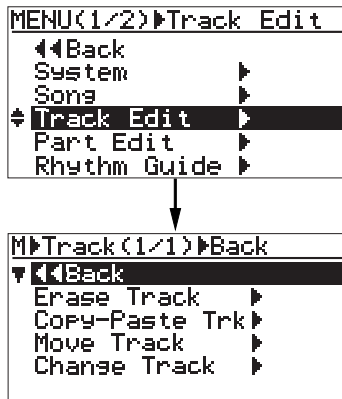

- 4) Rotate the [MENU/ENTER] knob to select "Change Track >", and press the [MENU/ENTER] knob.

The display now shows the screen for selecting the source track(s) and destination track(s) of the exchange operation.

"Source Track" selects the exchange source track(s), while "Dest. Track" selects the exchange destination track(s).

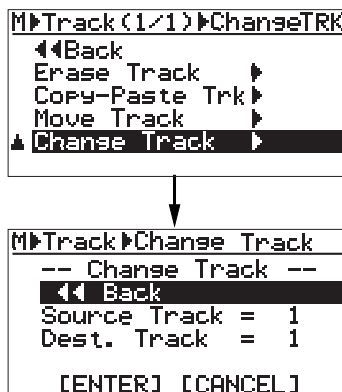

- 5) Rotate the [MENU/ENTER] knob to select "Source Track = *", and press the [MENU/ENTER] knob.

You can now select the desired exchange source track(s) by rotating the [MENU/ENTER] knob. The available options are:

- 1 through 8 (mono track)
- 1/2, 3/4, 5/6 and 7/8 (stereo tracks)

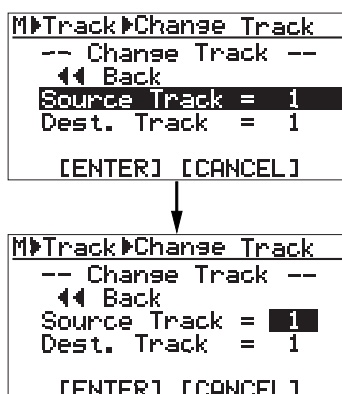

- 6) Rotate the [MENU/ENTER] knob to select the source track(s), and press the [MENU/ENTER] knob. You can now select the desired destination track(s).

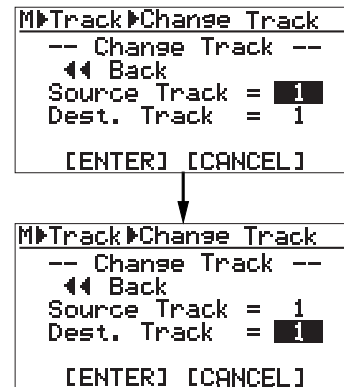

You can select the same number of tracks as the exchange source track(s). For example, if you select a mono track for the exchange source, you can only select a mono track for the exchange destination.

<Note>: You cannot select the same track(s) for the exchange source and destination.

- 7) Rotate the [MENU/ENTER] knob to select the destination track(s), and press the [MENU/ENTER] knob.

"Dest. Track = *" is now highlighted on the screen.

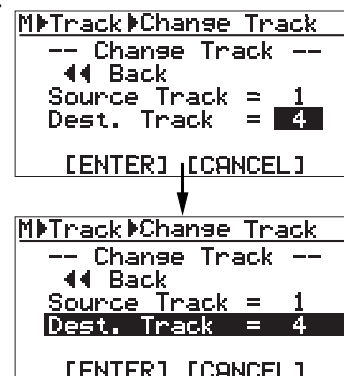

- 8) Rotate the [MENU/ENTER] knob to move the cursor to "[ENTER]" on the screen, and press the [MENU/ENTER] knob.

The display shows "Please Wait", immediately followed by "Completed" when the MR-8HD completes the exchange operation.

<Note>: If you want to cancel the exchange operation, move the cursor to "[CANCEL]" on the screen, and press the [MENU/ENTER] knob.

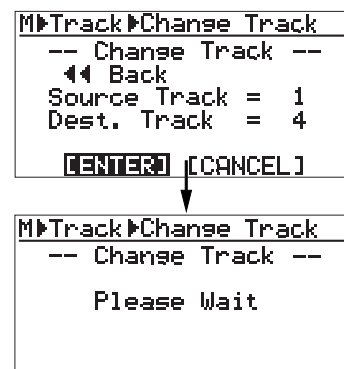

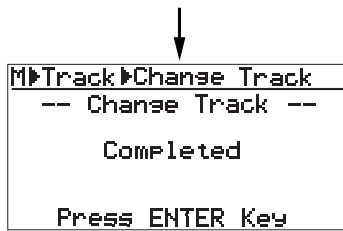

- 9) **Press the [MENU/ENTER] knob.**
The display now returns to the track edit menu screen, where “Change Track >” is highlighted.
- 10) **Press the [STOP] key to exit the menu mode.**

<Note> *If you are not satisfied with the result, press the [UNDO/REDO] key to undo the operation (see page 103).*

Part editing

This chapter describes how to edit a "part" (*) of recorded song. You can edit data of a track or tracks between the "LOCATE A" and "LOCATE B" points. Part editing does not consume the hard disk space. Therefore, the remaining space of the disk does not change by executing part editing.

<(*) About "part">

A "part" is defined as audio data between the "LOCATE A" and "LOCATE B" points. You can edit a "part" as described later.

Therefore, before carrying out part editing, the "LOCATE A" and "LOCATE B" points must be set. See page 49 for details about how to set these points.

You can set these points after entering the part editing mode (see the next page for details).

<Undo/redo of editing>

You can undo part editing. By pressing the [UNDO/REDO] key after executing part editing, the song returns to the original condition before editing.

By pressing the [UNDO/REDO] key after undoing part editing, you can again return the song to the condition after being edited.



[UNDO/REDO] key

<Notes>

Also note that if you carry out any of the following after editing, you cannot undo the editing anymore.

1. **Making new recording**
2. **Making new editing**
3. **Turning off the power**
4. **Loading another song**

<Notes>

While a menu screen is shown, you can go up the menu screen level or directly exit the menu mode by the following operations.

- (1) **Select "<< Back" on a menu screen and press the [MENU/ENTER] knob.**
The display returns to the previous (upper level) screen. Repeating this operation finally exits the menu mode.
- (2) **Press the [REWIND] key.**
The display returns to the previous (upper level) screen. Repeating this operation finally exits the menu mode.
- (2) **Press the [STOP] key.**
The menu mode exits and the display shows the home screen.

Playing back the "part" (between LOCATE A and LOCATE B) to be edited

You can play back audio of the "part" before carrying out edit operation. After setting the LOCATE A and LOCATE B points, follow the procedure below for checking the part. You can check the part before entering the menu mode, as well as while the part editing screen is shown.

- 1) **Press the [PLAY] key while holding down the [STOP] key.**
The MR-8HD starts playback between the LOCATE A and LOCATE B points (see also page 44).
- 2) **During playback, raise the appropriate track fader(s) and the [MASTER] fader.**
You can monitor only the "part" to be edited, so you can check the editing range.

You can change the LOCATE A and LOCATE B points during the edit operation, as well as before entering the editing mode (see the following for details).

Changing an edit point during editing

On the screen for selecting the target track(s) to be edited, you can see the current recorder position information (in ABS time or bar/beat/clock). The following screen example shows the screen for selecting the track(s) for part erasing.

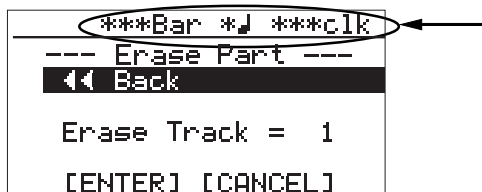

The time (or bar/beat/clock) value changes in realtime as the recorder moves (i.e. when it plays, fastforwards, rewinds, locates, etc.). When you carry out the locate operation to the LOCATE A or LOCATE B point and the current position matches the locate point, "LocA=" (or "LocB=") is shown to the left of the current position information, as shown below. This shows that the recorder is now at the LOCATE A (or LOCATE B) point.

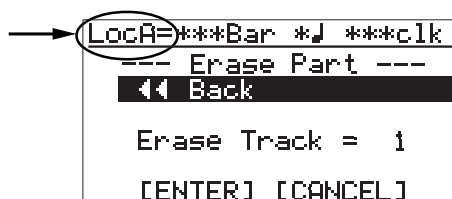

The LOCATE A or LOCATE B point can be changed while this screen is shown by following the procedure below.

- 1) **Move the recorder to the desired point by using the [PLAY], [REWIND] or [F FWD] key.**
- 2) **While the recorder is at the desired point, press the [STORE] key and followed by the [LOCATE A/IN] or [LOCATE B/OUT] key.**

The old editing point is overwritten by the new point. After setting the new editing point, "LocA=" (or "LocB=") is shown to the left of the current position information, as shown left.

After setting the new editing points, you can edit (erase, paste, move or exchange) data of newly specified part.

Erasing the part(s)

You can erase the part(s) on the selected track(s) of the current song.

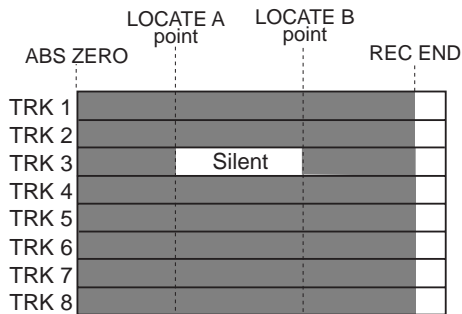

<Note>: You cannot erase the part(s) of a song which is protected. Release the song protection before erasing the part(s).

- 1) Load the song you want to edit.
- 2) Set the LOCATE A and LOCATE B points (see page 49).
You can check the part(s) by playing back the recorder between the LOCATE A and LOCATE B points (see page 44).
- 3) While the recorder is stopped, press the [MENU/ENTER] knob to enter the menu mode. The display now shows the first page of the menu selection screen, where "<< Back" is highlighted initially (selecting "<< Back" returns to the previous screen).

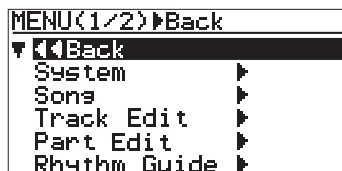

- 4) Rotate the [MENU/ENTER] knob to select "Part Edit >", and press the [MENU/ENTER] knob. The display now shows the part edit menu screen, where "<< Back" is highlighted.

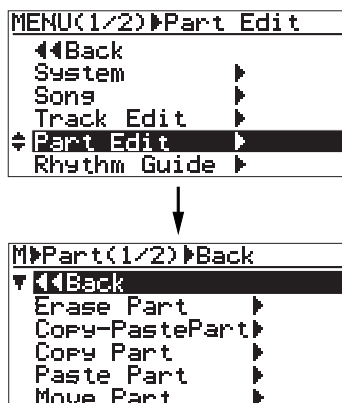

- 5) Rotate the [MENU/ENTER] knob to select "Erase Part >", and press the [MENU/ENTER] knob. The display now shows the screen for selecting a track or tracks of which you want to erase the part(s). On the screen, "<< Back" is initially highlighted.

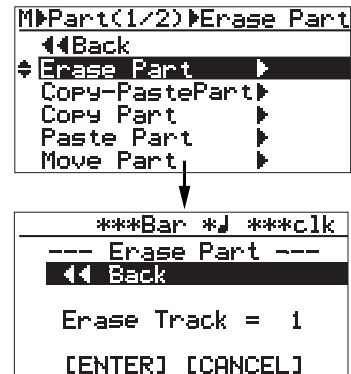

- 6) Rotate the [MENU/ENTER] knob to select "Erase Track = *", and press the [MENU/ENTER] knob. The current option starts flashing and you can now select the desired track(s) by rotating the [MENU/ENTER] knob. The available options are:

- 1 through 8 (mono track)
- 1/2, 3/4, 5/6 and 7/8 (stereo tracks)

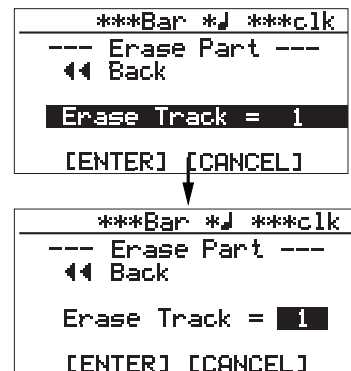

- 7) Rotate the [MENU/ENTER] knob to select the desired option, and press the [MENU/ENTER] knob.

The display returns to the previous screen.

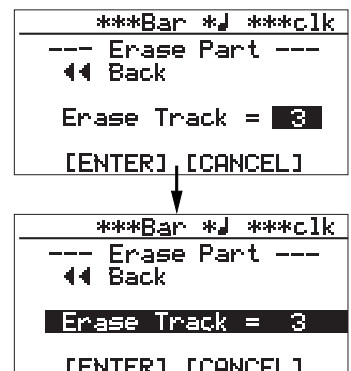

- 8) Rotate the [MENU/ENTER] knob to move the cursor to "[ENTER]" on the screen, and press the [MENU/ENTER] knob.

The display shows "Please Wait", immediately followed by "Completed" when the MR-8HD completes erasing.

If you want to cancel the part erase operation, move the cursor to "[CANCEL]" on the screen, and press the [MENU/ENTER] knob.

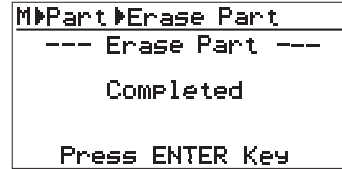
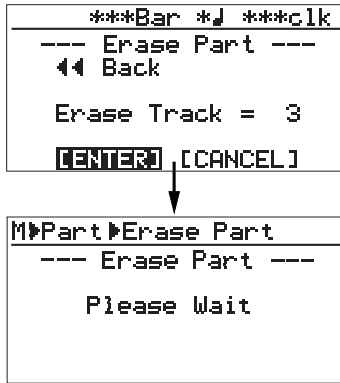

- 9) Press the [MENU/ENTER] knob. The display now returns to the part edit menu screen, where "Erase Part >" is highlighted.
- 10) Press the [STOP] key to exit the menu mode.

<Note>: If you are not satisfied with the result, press the [UNDO/REDO] key to undo the operation (see page 111).

Copying/pasting the part(s)-1

You can copy the desired part(s) of the selected track(s) and paste it(them) to the same time position of the other desired track(s). The copy/paste operation of a part or parts can be made only within the current song. You can also make the copy/paste operation of a part or parts using another method described later in "Copying/pasting the desired part(s) (2)".

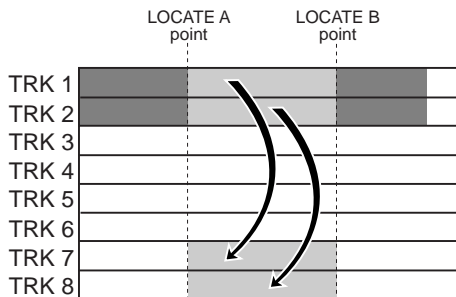

<Note>: You cannot copy/paste track data of a song protected. Release the protection before making the copy/paste operation.

<Note>: If you want to paste the copied part(s) to the desired time position of other track(s) other than the position between the LOCATE A and LOCATE B points, use the method described later in "Copying/pasting the desired part(s) (2)".

- 1) Load the song you want to edit.
- 2) Set the LOCATE A and LOCATE B points for specifying the desired part(s) (see page 49). You can check the part(s) by playing back between the LOCATE A and LOCATE B points (see page 44).

- 3) While the recorder is stopped, press the [MENU/ENTER] knob to enter the menu mode. The display now shows the first page of the menu selection screen, where "<< Back" is highlighted initially (selecting "<< Back" returns to the previous screen).

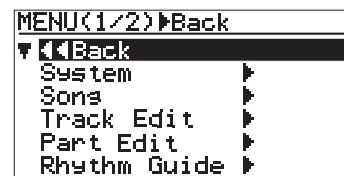

- 4) Rotate the [MENU/ENTER] knob to select "Part Edit >", and press the [MENU/ENTER] knob. The display now shows the part edit menu screen, where "<< Back" is highlighted.

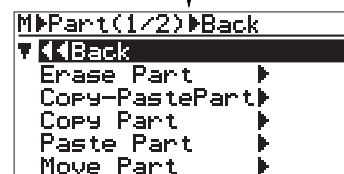
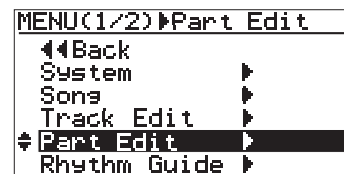

- 5) Rotate the [MENU/ENTER] knob to select "Copy-PastePart >", and press the [MENU/ENTER] knob. The display now shows the screen for selecting the source track(s) and destination track(s) of copy/paste. "<<Back" is initially highlighted.

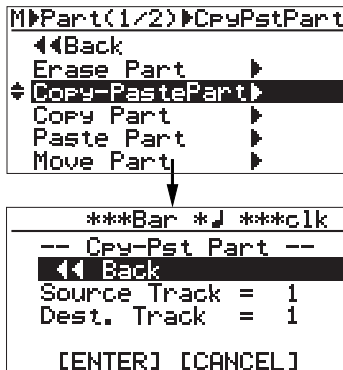

- 6) Rotate the [MENU/ENTER] knob to select "Source Track = *", and press the [MENU/ENTER] knob. The display now shows the screen for selecting the copy source track(s). You can select the copy source track(s) by rotating the [MENU/ENTER] knob. The available options are:

- 1 through 8 (mono track)
- 1/2, 3/4, 5/6 and 7/8 (stereo tracks)

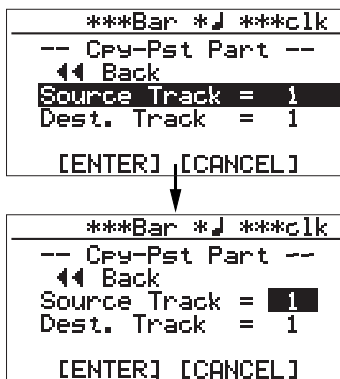

- 7) Rotate the [MENU/ENTER] knob to select the source track(s) to be copied, and press the [MENU/ENTER] knob. You can select the destination track(s) by rotating the [MENU/ENTER] knob. The available options are:

- 1 through 8 (mono track)
- 1/2, 3/4, 5/6 and 7/8 (stereo tracks)

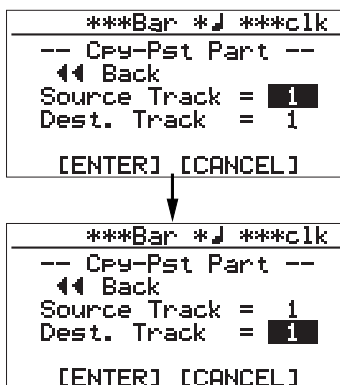

<Note>: You cannot select the same track(s) for the copy source and destination.

- 8) Rotate the [MENU/ENTER] knob to select the destination track(s), and press the [MENU/ENTER] knob. The display returns to the previous screen.

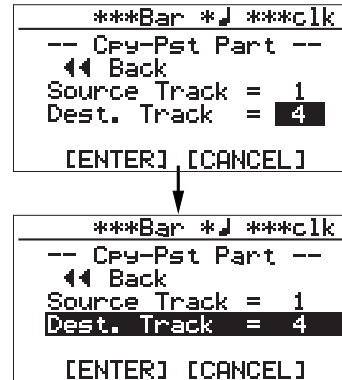

- 9) Rotate the [MENU/ENTER] knob to move the cursor to "[ENTER]" at the bottom of the screen, then press the [MENU/ENTER] knob. The display shows "Please Wait", immediately followed by "Completed" when the MR-8HD completes the copy/paste operation.

To cancel the copy/paste operation, move the cursor to "[CANCEL]" at the bottom of the screen, and press the [MENU/ENTER] knob.

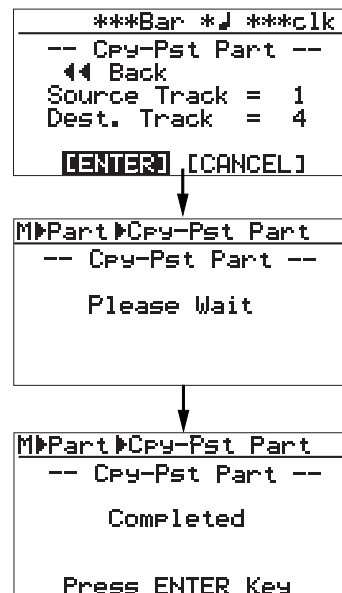

- 10) Press the [MENU/ENTER] knob. The display now returns to the part edit menu screen, where "Copy-Paste Part >" is highlighted.
- 11) Press the [STOP] key to exit the menu mode.

<Note>: If you are not satisfied with the result, press the [UNDO/REDO] key to undo the operation (see page 111).

Copying/pasting the part(s)-2

You can copy the desired part(s) of the selected track(s) and paste it(them) to the other time position of the desired track(s). Unlike the method described above in "Copying/pasting the desired part(s) (1)", the part data is copied to the (virtual) clipboard and then pasted to the specified position of the other specified track(s).

The copy/paste operation of a part or parts can be made only within the current song.

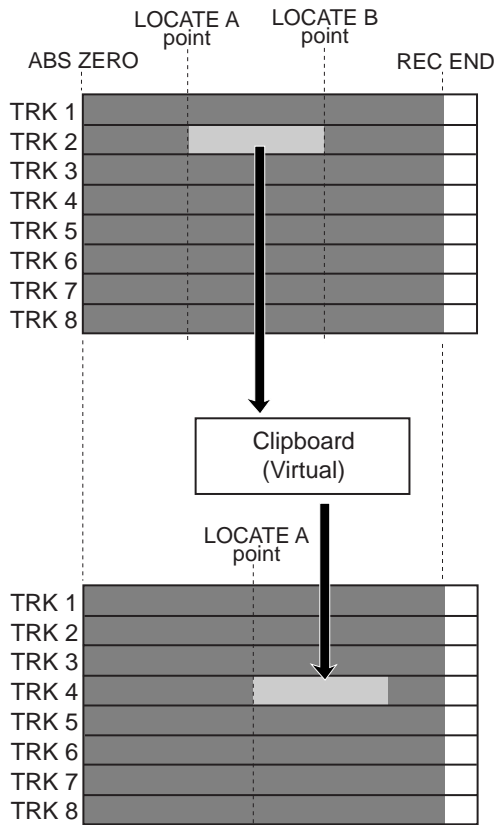

<Note>: If you paste the part(s) to the same time position of the other track(s), we recommend using the method described above in "Copying/pasting the desired part(s) (1)", because it works faster.

<Note>: You cannot copy/paste track data of a song protected. Release the protection before making the copy/paste operation.

<Note>: If you turn off the MR-8HD after copying the part data to the clipboard, the data on the clipboard is lost. Also note that you cannot undo copying data to the clipboard.

Copying to the clipboard

- 1) **Load the song you want to edit.**
- 2) **Set the LOCATE A and LOCATE B points (see page 49).**
You can check the edited part(s) by playing back between the LOCATE A and LOCATE B points (see page 44).

- 3) **While the recorder is stopped, press the [MENU/ENTER] knob to enter the menu mode.**
The display now shows the first page of the menu selection screen, where "<< Back" is highlighted initially (selecting "<< Back" returns to the previous screen).

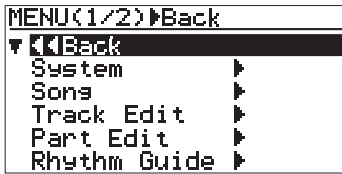

- 4) **Rotate the [MENU/ENTER] knob to select "Part Edit >", and press the [MENU/ENTER] knob.**
The display now shows the part edit menu screen, where "<< Back" is highlighted.

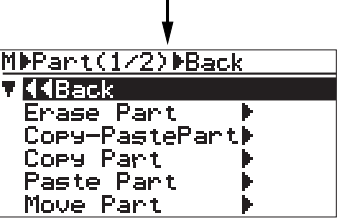
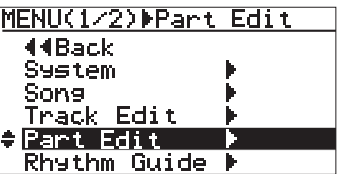

- 5) **Rotate the [MENU/ENTER] knob to select "Copy Part >", and press the [MENU/ENTER] knob.**
The display now shows the screen for selecting the source track(s). "<<Back" is initially highlighted.

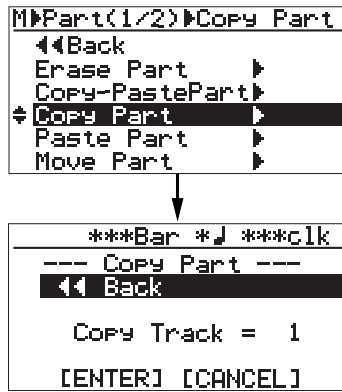

- 6) Rotate the [MENU/ENTER] knob to select "Copy Track >", and press the [MENU/ENTER] knob.

The display now shows the screen for selecting the copy source track(s). You can select the copy source track(s) by rotating the [MENU/ENTER] knob. The available options are:

- 1 through 8 (mono track)
- 1/2, 3/4, 5/6 and 7/8 (stereo tracks)

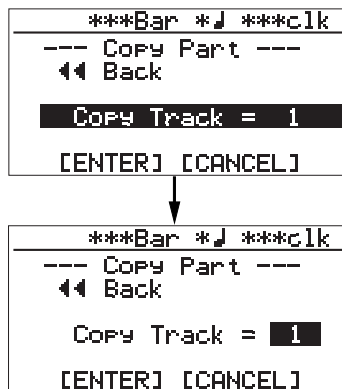

- 7) Rotate the [MENU/ENTER] knob to select the track(s) to be copied, and press the [MENU/ENTER] knob.

The display returns to the previous screen.

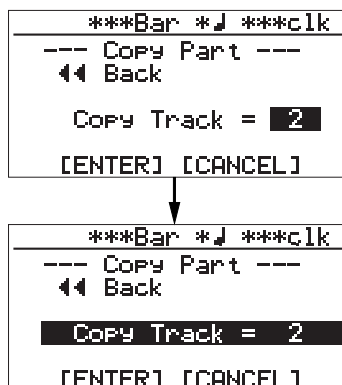

- 8) Rotate the [MENU/ENTER] knob to move the cursor to "[ENTER]" at the bottom of the screen, then press the [MENU/ENTER] knob.

The display shows "Please Wait", immediately followed by "Completed" when the MR-8HD completes the part copy operation.

To cancel the part copy operation, move the cursor to "[CANCEL]" at the bottom of the screen, and press the [MENU/ENTER] knob.

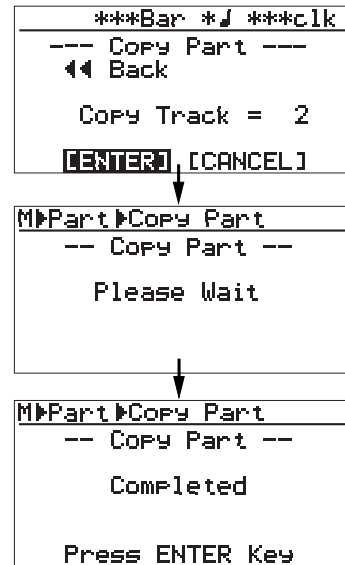

The display now returns to the part edit menu screen, where "Copy Part >" is highlighted.

The procedure example below shows how to paste the copied part data on the clipboard to the LOCATE A point of the selected track.

Pasting clipboard data

The following procedure is assumed that the LOCATE A point, the paste destination, is set

- 1) Rotate the [MENU/ENTER] knob to select "Paste Part >", and press the [MENU/ENTER] knob.

The display now shows the screen for selecting the paste destination track(s). "<< Back" is initially highlighted.

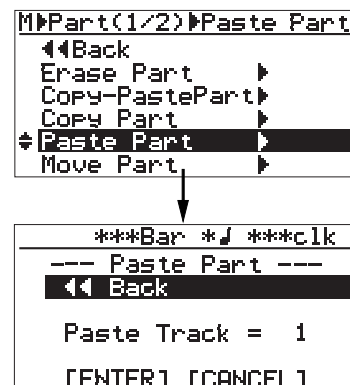

- 2) Rotate the [MENU/ENTER] knob to select "Paste Track = *", and press the [MENU/ENTER] knob.

You can now select the desired paste destination track(s) by rotating the [MENU/ENTER] knob. The available options are:

- 1 through 8 (mono track)
- 1/2, 3/4, 5/6 and 7/8 (stereo tracks)

```

***Bar *J ***clk
--- Paste Part ---
  44 Back
Paste Track = 1
[ENTER] [CANCEL]
    
```

```

***Bar *J ***clk
--- Paste Part ---
  44 Back
Paste Track = 1
[ENTER] [CANCEL]
    
```

- 3) Rotate the [MENU/ENTER] knob to select the paste destination track(s), and press the [MENU/ENTER] knob.
The display returns to the previous screen.

```

***Bar *J ***clk
--- Paste Part ---
  44 Back
Paste Track = 3
[ENTER] [CANCEL]
    
```

```

***Bar *J ***clk
--- Paste Part ---
  44 Back
Paste Track = 3
[ENTER] [CANCEL]
    
```

- 4) Rotate the [MENU/ENTER] knob to move the cursor to "[ENTER]" on the screen, and press the [MENU/ENTER] knob.
The display shows "Please Wait", immediately followed by "Completed" when the MR-8HD completes the paste operation.

If you want to cancel the part paste operation, move the cursor to "[CANCEL]" on the screen, and press the [MENU/ENTER] knob.

```

***Bar *J ***clk
--- Paste Part ---
  44 Back
Paste Track = 3
[ENTER] [CANCEL]
    
```

```

M▶Part▶Paste Part
--- Paste Part ---
Please Wait
    
```

```

M▶Part▶Paste Part
--- Paste Part ---
Completed
Press ENTER Key
    
```

<Note>: If you are going to carry out the paste operation when no data is pasted on the clipboard, the error message ("Clipboard Empty!") is shown on the display and the MR-8HD does not accept the operation. Press the [STOP] key to exit the menu mode and copy the desired data to the clipboard before carrying out the paste operation.

- 5) Press the [MENU/ENTER] knob.
The display now returns to the part edit menu screen, where "Paste Part >" is highlighted.

- 6) Press the [STOP] key to exit the menu mode.

<Note>: If you are not satisfied with the result, press the [UNDO/REDO] key to undo the operation (see page 111).

Moving the part(s)

You can move the desired part(s) of the desired track(s) to the other desired track(s). The part move operation can be made only within the current song. After the part move operation is carried out, the source part(s) becomes silent.

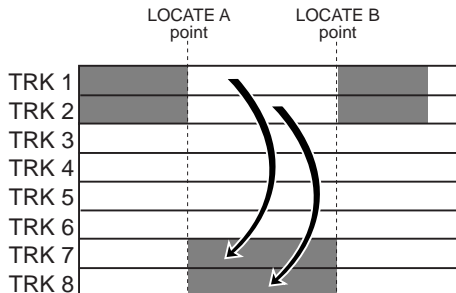

<Note> You cannot move data of a song protected. Release the protection before moving data.

- 1) Load the song you want to edit.
- 2) Set the LOCATE A and LOCATE B points (see page 49).
You can check the part(s) by playing back between the LOCATE A and LOCATE B points (see page 44).
- 3) While the recorder is stopped, press the [MENU/ENTER] knob to enter the menu mode. The display now shows the first page of the menu selection screen, where "<< Back" is highlighted initially (selecting "<< Back" returns to the previous screen).

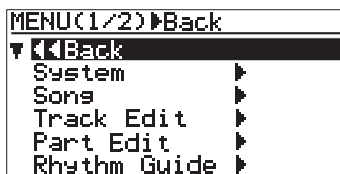

- 4) Rotate the [MENU/ENTER] knob to select "Part Edit >", and press the [MENU/ENTER] knob. The display now shows the part edit menu screen, where "<< Back" is highlighted.

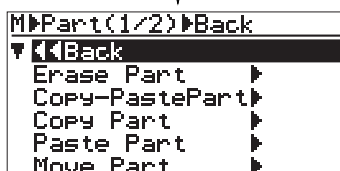
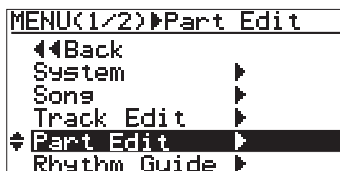

- 5) Rotate the [MENU/ENTER] knob to select "Move Part >", and press the [MENU/ENTER] knob.

The display now shows the screen for selecting the source track(s) and destination track(s) of the move operation. Initially, "<< Back" is highlighted.

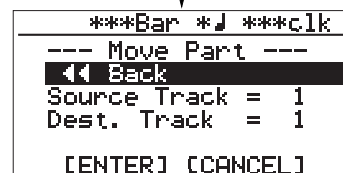
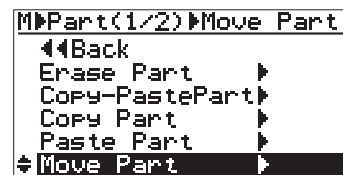

- 6) Rotate the [MENU/ENTER] knob to select "Source Track = *", and press the [MENU/ENTER] knob.

You can now select the move source track(s) by rotating the [MENU/ENTER] knob. The available options are:

- 1 through 8 (mono track)
- 1/2, 3/4, 5/6 and 7/8 (stereo tracks)

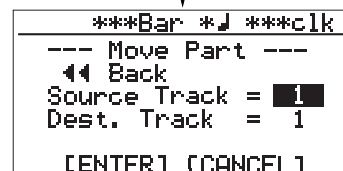
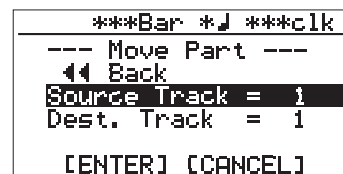

- 7) Rotate the [MENU/ENTER] knob to select the move source track(s), and press the [MENU/ENTER] knob.

You can now select the move destination track(s) by rotating the [MENU/ENTER] knob. The available options are:

- 1 through 8 (mono track)
- 1/2, 3/4, 5/6 and 7/8 (stereo tracks)

```

***Bar *J ***clk
--- Move Part ---
  Back
Source Track = 1
Dest. Track = 1
[ENTER] [CANCEL]
    
```

```

***Bar *J ***clk
--- Move Part ---
  Back
Source Track = 1
Dest. Track = 1
[ENTER] [CANCEL]
    
```

<Note>: You cannot select the same track(s) for the move source and destination.

- 8) Rotate the [MENU/ENTER] knob to select the destination track(s), and press the [MENU/ENTER] knob.

The display returns to the screen where "Dest. Track = *" is highlighted.

```

***Bar *J ***clk
--- Move Part ---
  Back
Source Track = 1
Dest. Track = 4
[ENTER] [CANCEL]
    
```

```

***Bar *J ***clk
--- Move Part ---
  Back
Source Track = 1
Dest. Track = 4
[ENTER] [CANCEL]
    
```

- 9) Rotate the [MENU/ENTER] knob to move the cursor to "[ENTER]" on the screen, and press the [MENU/ENTER] knob.

The display shows "Please Wait", immediately followed by "Completed" when the MR-8HD completes the move operation.

If you want to cancel the move operation, move the cursor to "[CANCEL]" on the screen, and press the [MENU/ENTER] knob.

```

***Bar *J ***clk
--- Move Part ---
  Back
Source Track = 1
Dest. Track = 4
[ENTER] [CANCEL]
    
```

```

MPart Move Part
--- Move Part ---
Please Wait
    
```

```

MPart Move Part
--- Move Part ---
Completed
Press ENTER Key
    
```

- 10) Press the [MENU/ENTER] knob.
The display now returns to the part edit menu screen, where "Move Part >" is highlighted.
- 11) Press the [STOP] key to exit the menu mode.

<Note>: If you are not satisfied with the result, press the [UNDO/REDO] key to undo the operation (see page 111).

Exchange the part(s)

You can exchange the parts between the desired tracks. The part exchange operation can be made only within the current song.

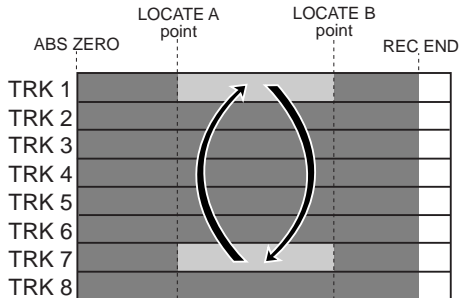

<Note>: You cannot exchange data of a song protected. Release the protection before exchanging parts.

- 1) Load the song you want to edit.
- 2) Set the LOCATE A and LOCATE B points (see page 49).
You can check the parts by playing back between the LOCATE A and LOCATE B points (see page 44).
- 3) While the recorder is stopped, press the [MENU/ENTER] knob to enter the menu mode. The display now shows the first page of the menu selection screen, where "<< Back" is highlighted initially (selecting "<< Back" returns to the previous screen).

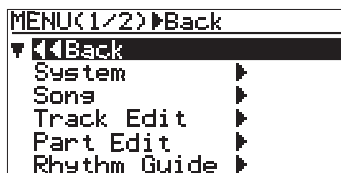

- 4) Rotate the [MENU/ENTER] knob to select "Part Edit >", and press the [MENU/ENTER] knob. The display now shows the part edit menu screen, where "<< Back" is highlighted.

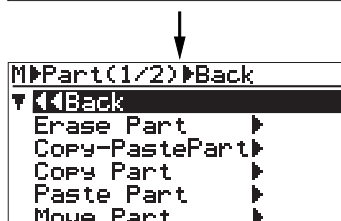

- 5) Rotate the [MENU/ENTER] knob to select "Change Part >" in the second page, and press the [MENU/ENTER] knob.

The display now shows the screen for selecting the source track(s) and destination track(s) of the exchange operation. Initially, "<< Back" is highlighted.

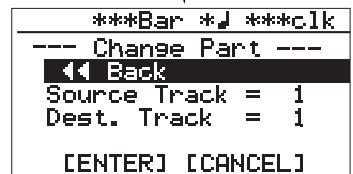
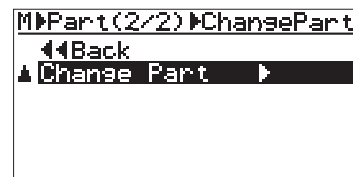

- 6) Rotate the [MENU/ENTER] knob to select "Source Track=*", and press the [MENU/ENTER] knob.

You can now select the exchange source track(s) by rotating the [MENU/ENTER] knob. The available options are:

- 1 through 8 (mono track)
- 1/2, 3/4, 5/6 and 7/8 (stereo tracks)

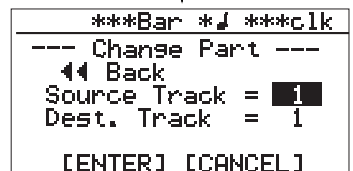
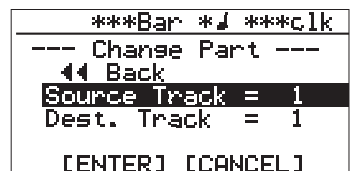

- 7) Rotate the [MENU/ENTER] knob to select the source track(s) to be exchanged, and press the [MENU/ENTER] knob.

You can now select the exchange destination track(s) by rotating the [MENU/ENTER] knob. The available options are:

- 1 through 8 (mono track)
- 1/2, 3/4, 5/6 and 7/8 (stereo tracks)

<Note>: You cannot select the same track(s) for the exchange source and destination.

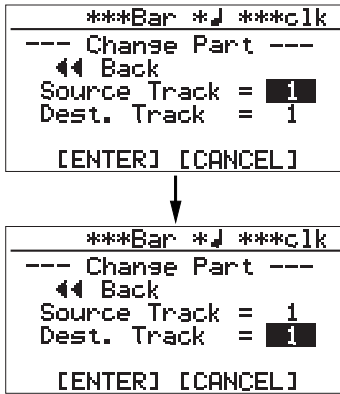

- 8) Rotate the [MENU/ENTER] knob to select the destination track(s), and press the [MENU/ENTER] knob.

The display shows the screen where "Dest. Track = **" is highlighted.

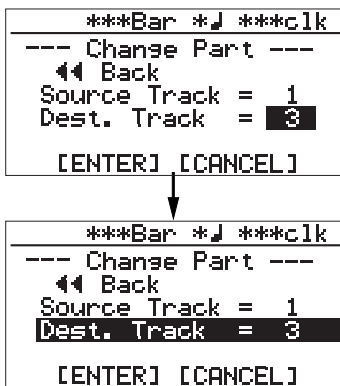

- 9) Rotate the [MENU/ENTER] knob to move the cursor to "[ENTER]" on the screen, and press the [MENU/ENTER] knob.

The display shows "Please Wait", immediately followed by "Completed" when the MR-8HD completes the exchange operation.

If you want to cancel the exchange operation, move the cursor to "[CANCEL]" on the screen, and press the [MENU/ENTER] knob.

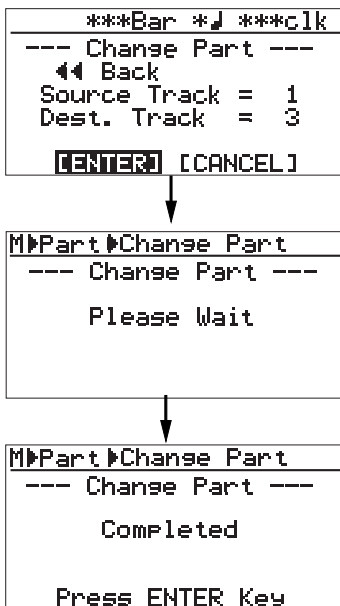

- 10) Press the [MENU/ENTER] knob.
 The display now returns to the part edit menu screen, where "Change Part >" is highlighted.
- 11) Press the [STOP] key to exit the menu mode.

<Note>: If you are not satisfied with the result, press the [UNDO/REDO] key to undo the operation (see page 111).

Other functions

This chapter describes the following functions which are important for using the MR-8HD.

- (1) **Hard disk formatting**
- (2) **Peak hold time setting**
- (3) **Pre-roll/post-roll time setting**
- (4) **Beat resolution mode on/off**
- (5) **Phantom power on/off**
- (6) **Initializing the MR-8HD**

<Notes>

While a menu screen is shown, you can go up the menu screen level or directly exit the menu mode by the following operations.

- (1) **Select “<< Back” on a menu screen and press the [MENU/ENTER] knob.**
The display returns to the previous (upper level) screen. Repeating this operation finally exits the menu mode.
- (2) **Press the [REWIND] key.**
The display returns to the previous (upper level) screen. Repeating this operation finally exits the menu mode.
- (3) **Press the [STOP] key.**
The menu mode exits and the display shows the home screen.

Hard disk formatting

You can reformat the MR-8HD internal hard disk by using the FAT32 file system. By reformatting the hard disk, all existing song data on the hard disk is erased, while all setting data including the menu settings are initialized, and a new song (Song01) is automatically created.

<Note>: You cannot undo hard disk formatting. Therefore, before executing hard disk formatting, make sure that all song data on the hard disk is not necessary.

- 1) While the recorder is stopped, press the [MENU/ENTER] knob to enter the menu mode. The display now shows the first page of the menu selection screen, where "<< Back" is highlighted initially. You can select between "0.1s" and "10s" in 0.1 second steps.

```

MENU(1/2)▶Back
◀◀Back
System ▶
Songs ▶
Track Edit ▶
Part Edit ▶
Rhythm Guide ▶
  
```

- 2) Rotate the [MENU/ENTER] knob to select "System", and press the [MENU/ENTER] knob. The display now shows the first page of the system menu screen, where "<< Back" is highlighted.

```

MENU(1/2)▶System
◀◀Back
◀ System ▶
Songs ▶
Track Edit ▶
Part Edit ▶
Rhythm Guide ▶
  
```

```

M▶System(1/2)▶Back
◀◀Back
Pre Roll Time = 4.0s
PostRoll Time = 1.0s
Delay Type = L-R
Midi Sync Out = Off
MTC Frame Rate= 25
  
```

- 3) Rotate the [MENU/ENTER] knob to select "Disk Format" on the second page and press the [MENU/ENTER] knob. The display shows the screen where "Are You Sure?" flashes. As this screen indicates, formatting the hard disk deletes all songs on the disk and you cannot undo disk formatting. To stop formatting, press the [STOP] key to exit the menu mode.

```

M▶System(2/2)▶Format
◀◀Back
PeakHold Time = 3s
Resolution = Off
◀ Disk Format ▶
Init Memory ▶
  
```

```

M▶System▶Format
-- Disk Format --
Delete All Songs
Can't Undo
Are You Sure?
Yes▶RECORD+ENTER Key
No▶STOP Key
  
```

- 4) Press the [MENU/ENTER] knob while holding down the [RECORD] key. Formatting starts. When formatting completes, "Completed!" is shown on the display and the MR-8HD stops disk access.

```

M▶System▶Format
-- Disk Format --
Formattins...
  
```

```

M▶System▶Format
-- Disk Format --
Completed
Press ENTER Key
  
```

- 6) Press the [MENU/ENTER] knob. The MR-8HD exits the menu mode. The display changes to the home screen for Song01 (song name: Song01) which is automatically created after formatting.

```

- 2 bar 1,000 clk
Song01
..... 0 ..... Song01
..... 0 .....
..... 48 .....
1 2 3 4 5 6 7 8 LF
  
```

Peak hold time setting

The level meters shown on the display have the peak hold function. When it is enabled, the meter peak value during recording is held for the specified time.

The default meter peak hold time is three seconds. You can disable the peak hold function or change the peak hold time.

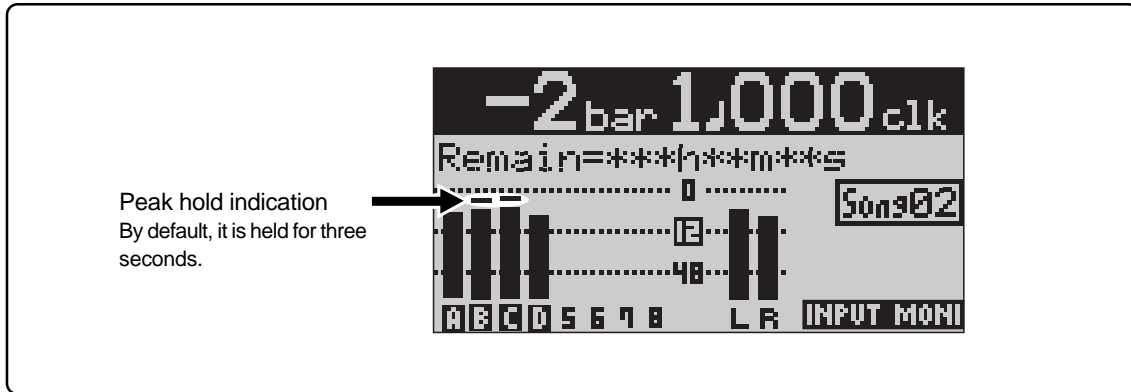

- 1) While the recorder is stopped, press the [MENU/ENTER] knob to enter the menu mode. The display now shows the first page of the menu selection screen, where "<< Back" is highlighted initially. You can select between "0.1s" and "10s" in 0.1 second steps.

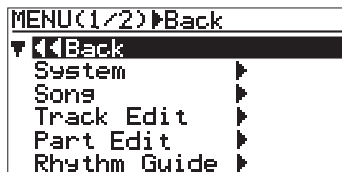

- 2) Rotate the [MENU/ENTER] knob to select "System", and press the [MENU/ENTER] knob. The display now shows the first page of the system menu screen, where "<< Back" is highlighted.

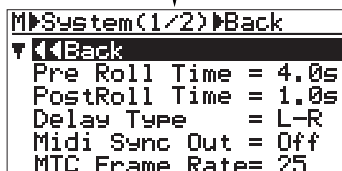
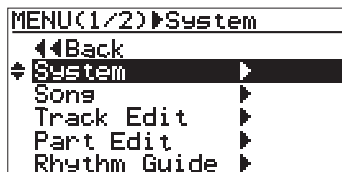

- 3) Rotate the [MENU/ENTER] knob to select "PeakHold Time" on the second page and press the [MENU/ENTER] knob. The currently selected peak hold time (by default, "3s") flashes. You can now make the desired peak hold setting.

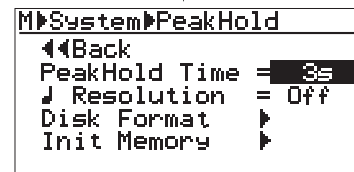
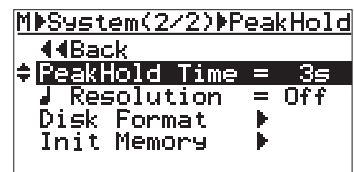

You can select from "3s" (3 seconds, default), "1s", "2s", "5s" and "Off".

When "Off" is selected, the peak hold function is disabled (the peak value is not held).

- 4) Rotate the [MENU/ENTER] knob to select the desired hold time, and press the [MENU/ENTER] knob. The peak hold setting is confirmed and the display returns to the previous screen.
- 5) Press the [STOP] key to exit the menu mode. The peak hold setting is effective to all songs.

Pre-roll/post-roll time setting

As described earlier on page 47, when both the auto punch in/out and loop modes are active, the pre-roll and post-roll are effective in the loop function.

You can set the pre-roll and post-roll time value by the following procedure.

When both the auto punch in/out and loop modes are active, the loop starts from "the LOCATE A point minus the pre-roll time" and ends by "the LOCATE B point plus the post-roll time". The pre-roll time is initially set to four seconds, while the post-roll time is set to one second.

In other words, with the default pre-roll and post-roll time settings, when executing auto punch in/out, the MR-8HD starts playback four seconds before the punch-in point, and ends playback one second after the punch-out point.

- 1) **While the recorder is stopped, press the [MENU/ENTER] knob to enter the menu mode.**
The display now shows the first page of the menu selection screen, where "<< Back" is highlighted initially.
You can also return to the previous screen by pressing the [REWIND] key.

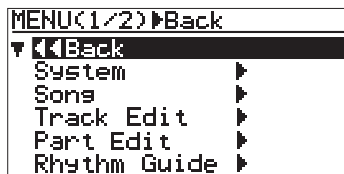

- 2) **Rotate the [MENU/ENTER] knob to select "System", and press the [MENU/ENTER] knob.**
The display now shows the first page of the system menu screen, where "<< Back" is highlighted.

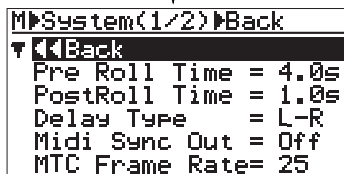
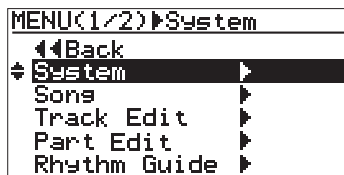

- 3) **Rotate the [MENU/ENTER] knob to select "Pre Roll Time" and press the [MENU/ENTER] knob.**
The currently selected pre-roll time (by default, "4.0s") flashes. You can now set the desired pre-roll time.

You can select between "0.1s" and "10s" in 0.1 second steps.

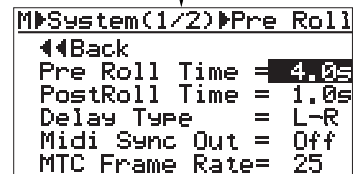
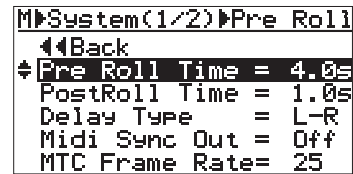

- 4) **Rotate the [MENU/ENTER] knob to select the pre-roll hold time, and press the [MENU/ENTER] knob.**

The pre-roll time setting is confirmed and the display returns to the previous screen. To set the post-roll time, follow the procedure below.

- 5) **Rotate the [MENU/ENTER] knob to select "Post Roll Time" and press the [MENU/ENTER] knob.**

The currently selected post-roll time (by default, "1.0s") flashes. You can now set the desired post-roll time.

You can select between "0.1s" and "10s" in 0.1 second steps.

- 6) **Rotate the [MENU/ENTER] knob to select the post-roll hold time, and press the [MENU/ENTER] knob.**

The post-roll time setting is confirmed and the display returns to the previous screen.

- 7) **Press the [STOP] key to exit the menu mode.**

Beat resolution mode on/off

While the time base is set to the bar/beat mode, if you set the "Beat resolution" item in the menu to "On", the LOCATE A and B points are set in beat resolution.

When "Beat resolution" is set to "On", the clock digit in the bar/beat/clock value is automatically rounded down or up, so that the clock digit is always "000".

Let's see an example when the time base is set to the bar/beat mode and the "Beat resolution" is set to "On". If you set the LOCATE A point to "Bar 1/1♩/clock 468" and the LOCATE B point to "Bar 12/4♩/clock 485", the rounded values are stored as below.

"Bar 1 / 1♩ / clock 468" -> "Bar 1 / 1♩ / clock 000"
(The clock value "468" is rounded down.)

"Bar 12 / 4♩ / clock 485" -> "Bar 3 / 1♩ / clock 000"
(The clock value "485" is rounded up.)

- 1) While the recorder is stopped, press the [MENU/ENTER] knob to enter the menu mode. The display now shows the first page of the menu selection screen, where "<< Back" is highlighted initially. You can also return to the previous screen by pressing the [REWIND] key.

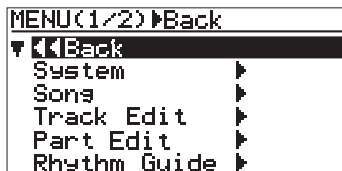

- 2) Rotate the [MENU/ENTER] knob to select "System", and press the [MENU/ENTER] knob. The display now shows the first page of the system menu screen, where "<< Back" is highlighted.

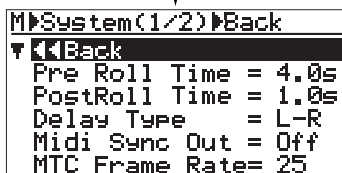
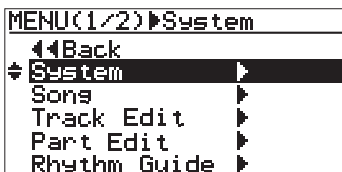

- 3) Rotate the [MENU/ENTER] knob to select "♩ Resolution" on the second page and press the [MENU/ENTER] knob. The current option (by default, "Off") flashes. You can now set the desired option.

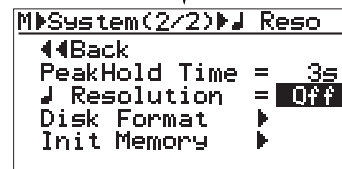
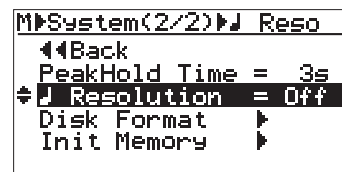

- 4) Rotate the [MENU/ENTER] knob to select "On" or "Off", and press the [MENU/ENTER] knob. The selection is confirmed and the display returns to the previous screen.
- 5) Press the [STOP] key to exit the menu mode.

Phantom power on/off

The MR-8HD can supply phantom power (+48 V) to the XLR balanced connectors of [INPUT A] through [INPUT D].

So you can connect condenser microphones which require phantom power.

You can turn on or off phantom power to the XLR connectors via the menu mode.

<Note>: The phantom power can be supplied to the XLR balanced connectors of [INPUT A] through [INPUT D]. Therefore, to connect a sound source which does not require the phantom power, use any of the unbalanced phone input jacks on [INPUT A] through [INPUT D].

If any plug is inserted to the unbalanced phone input jack, the phantom power is not supplied to the balanced XLR connector on the same channel.

The phantom power setting returns to "Off" (default) when you turn off the MR-8HD power.

<Notes on using phantom power>

- Confirm that the connected microphone needs +48 V phantom power.
- Turn on the phantom power after making microphone connection.
- Mute the outputs of the MR-8HD when turning on or off the phantom power or plugging/unplugging the microphone.
- Do not supply the phantom power to a microphone such as below.
 - * A microphone whose output is unbalanced
 - * A high impedance microphone
 - * A microphone whose pin 1 and pin 2 or pin 1 and pin 3 are short-circuited.
 - * A microphone with the grounded center tapout such as an old-fashioned ribbon microphone

<Tip>

You can directly access to the input menu screen by a long press of the desired [TO STEREO BUSS ON/OFF] key. For example, a long press of the [TO STEREO BUSS ON/OFF] key of [INPUT A] directly accesses to the screen shown below.

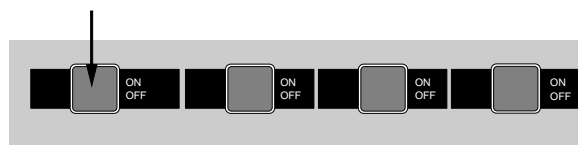

[TO STEREO BUSS ON/OFF] key

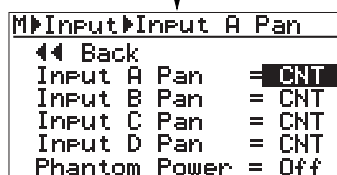

- 1) While the recorder is stopped, press the [MENU/ENTER] knob to enter the menu mode. The display now shows the first page of the menu selection screen, where "<< Back" is highlighted initially.

You can also return to the previous screen by pressing the [REWIND] key.

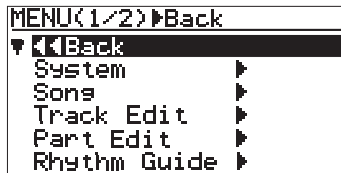

- 2) Rotate the [MENU/ENTER] knob to select "Input" on the second page, and press the [MENU/ENTER] knob. The display now shows the input menu screen.

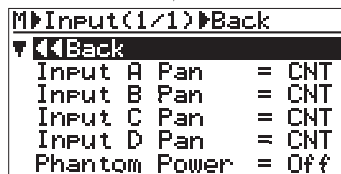
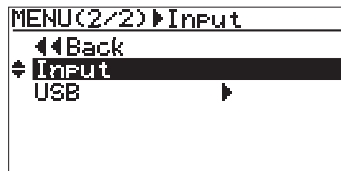

- 3) Rotate the [MENU/ENTER] knob to select "Phantom Power", and press the [MENU/ENTER] knob. The current option (by default, "Off") flashes. You can now set the desired option.

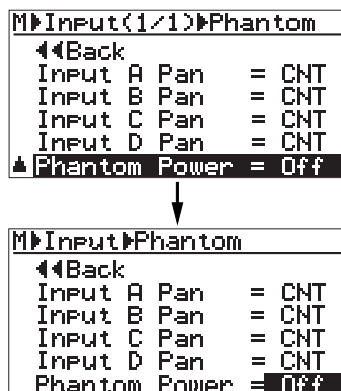

- 4) Rotate the [MENU/ENTER] knob to select "On", and press the [MENU/ENTER] knob. The screen shows a warning message for few seconds, and returns to the previous screen. While the message is shown, all input channels are muted. When the message is dismissed, the mute is released. If you select "Off" from "On", a warning message appears and all channels are muted.

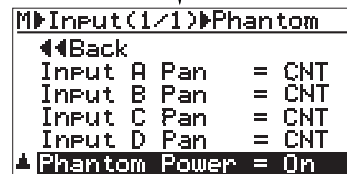
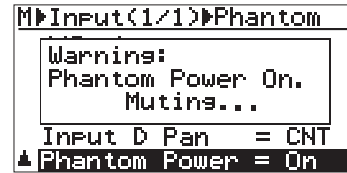
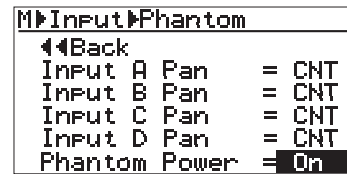

- 5) After making "Phantom Power" setting, press the [STOP] key to exit the menu mode. The display returns to the home screen.

When "Phantom Power" is set to "On", "48" lights on the home screen, as below.



Initializing the MR-8HD

By initializing the MR-8HD, you can initialize all global menu settings common to all songs, as well as the time base and display contrast level.

Initialized item	Default setting
Pre-roll time setting	4 seconds
Post-roll time setting	1 second
Delay type setting	L-R (stereo) delay
MIDI sync out setting	Off
MTC frame rate setting	25 frames
Beat resolution mode setting	Off
Peak hold time setting	3 seconds
Time base (shown when turning on the power)	Bar/Beat
Display contrast level	Factory present level

- 1) While the recorder is stopped, press the [MENU/ENTER] knob to enter the menu mode. The display now shows the first page of the menu selection screen, where "<< Back" is highlighted initially. You can also return to the previous screen by pressing the [REWIND] key.

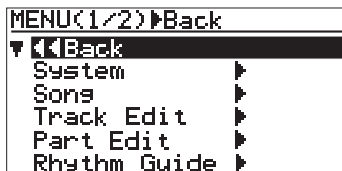

- 2) Rotate the [MENU/ENTER] knob to select "System", and press the [MENU/ENTER] knob. The display now shows the first page of the system menu screen, where "<< Back" is highlighted.

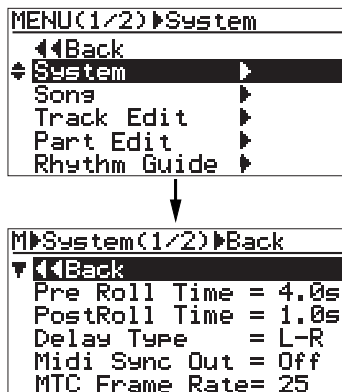

- 3) Rotate the [MENU/ENTER] knob to select "Inti. Memory" on the second page, and press the [MENU/ENTER] knob. The display now shows the confirmation screen for initializing.

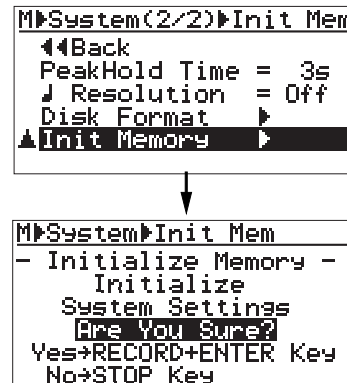

- 4) Press the [MENU/ENTER] knob while holding down the [RECORD] key. The settings are immediately initialized. The initialize is confirmed and the display returns to the previous screen. To cancel the initialization, press the [STOP] key.

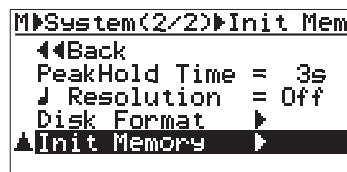

- 5) Press the [STOP] key to exit the menu mode.

Troubleshooting

If you encounter any problem while operating the MR-8HD, check the following for the possible cause of the problem before contacting our service station or dealer.

Troubles for recording

<Trouble 1>

I cannot record the sound source connected to [INPUT B] to track 1.

- **When recording a sound source to a mono track, you can only use the [INPUT A] section.**
Connect the source to [INPUT A].

<Trouble 2>

I cannot record the sound sources connected to [INPUT C] and [INPUT D] to tracks 1 and 2.

- **When recording two sound sources simultaneously, you must use [INPUT A] and [INPUT B]. You cannot use [INPUT C] and [INPUT D].**
Reconnect the sources to [INPUT A] and [INPUT B].

<Trouble 3>

The input level of the track to which I am going to record is too low.

- **Is the [TRIM] control of the input to which the sound source is connected adjusted appropriately?**
To set the input level (= recording level) appropriately, use the [TRIM] control so that the peak indicator does not light continuously.

<Trouble 4>

I cannot hear the input signal via the headphones though the [REC SELECT] key is active.

- **Did you press the [RECORD] key to make the armed track in the input monitor mode? Is the [PHONES VOL] control raised?**
You cannot hear the input signal unless the assigned track is in the input monitor mode by pressing the corresponding [REC SELECT] key to turn on the indicator. Also, you cannot hear any signal if the [PHONES VOL] control is set to minimum.

<Trouble 5>

The meter shows very low level and the recording level is too low.

- **Is the [TRIM] control for the input section the sound source is connected adjusted appropriately?**
Set the [TRIM] control just below the position where the [PEAK] indicator in the [INPUT A] section lights at the loudest part.

<Trouble 6>

The meter shows good level for recording, but no signal can be monitored via headphones though the [PHONES VOL] control is raised.

- **Are the track fader for the recording track and the [MASTER] fader raised?**
Both of these faders, as well as the [PHONES VOL] control, have to be raised in order to monitor the recording signal via headphones. We recommend to raise both the track fader for the recording track and the [MASTER] fader to the "≡" position.
- **Is the recording track in the input monitor mode?**
Make sure that the [RECORD] key flashes and "INPUT MONI" is shown on the display. If not, press the [RECORD] key to set the armed track to the input monitor mode.

<Trouble 7>

During overdubbing, I cannot monitor the playback signal of the recorded track.

- **Is the track fader for the playback track raised?**
During overdubbing, raise the faders for both the playback and recording tracks appropriately. Otherwise, you cannot make overdubbing while listening to the recorded track(s).

<Trouble 8>

I cannot execute auto punch in/out.

- **Is "AUTO PUNCH" shown on the screen?**
If it is not, press the [AUTO PUNCH] key to make the auto punch in/out function active.
- **Are the punch-in and punch-out points set correctly?**
To check each point, press the [LOCATE A/IN] or [LOCATE B/OUT] key. The recorder locates to the punch-in or punch-out point, while the screen shows the appropriate time data.

If the punch-out point is earlier than the punch-in point, set these points appropriately so that the punch-in point is earlier than the punch-out point.

<Trouble 9>

I cannot record audio data of a song onto an external digital recorder.

- **Is the connection between the [DIGITAL OUT] connector on the MR-8HD and the optical input connector of the digital recorder made correctly?**
Check the connection, as well as the optical cable.
- **Is the digital recorder set correctly for recording the signal fed to the digital input?**
See the manual of the digital recorder for details about the setting.

Troubles for playback

<Trouble 1>

During playback, the recorder suddenly executes locating.

- **Is "AUTO RTN" or "LOOP" shown on the display?**
If so, the play mode is set to the auto return or loop mode.
Press the [PLAY MODE] key until "Off" is selected.

<Trouble 2>

Cannot monitor the playback sound.

- **Are the track fader(s) for the playback track(s) and the [MASTER] fader brought up to the appropriate positions?**
Raise the fader(s) for the track(s) you want to monitor, as well as the [MASTER] fader.
If you monitor via headphones, also raise the [PHONES VOL] control.

<Trouble 3>

I press the [PLAY] key while holding down the [STOP] key, but I cannot execute loop playback.

- **Are the LOCATE A and LOCATE B points set correctly?**
By default, both of these points are set to the beginning of a song (i.e. "0m00s000ms" or "-2bar 1ÅÜ 00clk"). In this condition, you cannot execute loop playback.
Also, if the LOCATE B point is earlier than the LOCATE A point, you cannot execute loop playback.

Troubles for effect

<Trouble 1>

I cannot apply the effects.

- Are the [EFFECT SEND] control for the track you want to apply the effect and track fader raised appropriately?

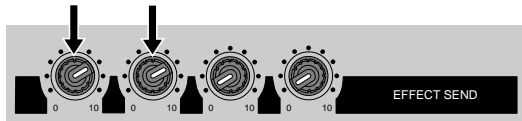

Raise the [EFFECT SEND] control(s) for the track(s) (1 through 4) you want to apply the effect to send signal(s) to the internal digital effects. Also, make sure that the fader(s) for the track(s) you want to apply the effect is(are) raised.

<Trouble 2>

I cannot apply the mic simulation effects.

- Is the [INPUT A SEL] switch on the rear panel is set to "MIC/LINE" position?

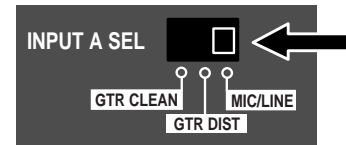

To apply the mic simulation effects to [INPUT A], the [INPUT A SEL] switch on the rear panel must be set to "MIC/LINE" position. When you set the switch to any other position, you can use the amp simulation effects for insert effects.

Troubles for USB connection

<Trouble 1>

Cannot export a WAV file to a personal computer.

- **Is the USB cable connected correctly?**
Check the connection, as well as the USB cable.
- **Is the personal computer meets the requirement?**
The MR-8HD can export a WAV file to a personal computer which runs on any of the following OS systems.

Windows Me, 2000 or XP
Macintosh OS X or higher

<Trouble 2>

The MR-8HD drive icon is not shown on the personal computer screen.

- **It may take some times for showing a removable drive depending on a personal computer.**

It may take some times for reading the drive data. Wait for a while until the drive icon appears.

On a Windows machine, the MR-8HD is shown as "removable drive". On a Macintosh machine, it is shown as "MR-8HD".

Other troubles

<Trouble 1>

I cannot hear the rhythm guide click.

- **Is the [RHYTHM GUIDE] key is illuminated?**
When the [RHYTHM GUIDE] key is not illuminated, the rhythm guide function is not active and you cannot hear the rhythm guide click.
- **Is the "Int Click level" item in the "Rhythm Guide" menu set correctly?**
If the "Int Click level" item is set to "00" or a small value, you cannot hear the rhythm guide click.

<Trouble 2>

I want to hear the rhythm guide click based on the "Signature" and "Tempo" settings on the rhythm guide setting screen but the rhythm guide click based on the conductor map is output.

- **Is the "Conductor Map" setting on the rhythm guide setting screen set to "On"?**
As shown on the screen below, if "Conductor Map" on the rhythm guide setting screen is set to "On", the rhythm guide click based on the conductor map is output. In this condition, the "Signature" and "Tempo" fields on this screen indicate "---" as below, showing that they are disabled.

```

M▶Rhythm<1/1>▶Back
◀ Back
Rhythm Guide = On
Conductor Map = On
Signature     = ---
Tempo        = ---bpm
Int ClickLevel= 80
  
```

Set "Conductor Map" to "Off" (see page 77).

MR-8HD Specifications

Specifications

[Inputs/Outputs]

0dBu=0.775Vrms, 0dBV=1.0Vrms, Reference level: -12dBfs

Analog input [INPUT A - INPUT D]

Connectors : XLR-3-31 type (#2: hot balanced)
: 1/4-inch, phone type
Input level : -48dBu (MIC) to +4dBu (LINE)
Input impedance : 1.5k Ω or more
: 400k Ω or more (When the INPUT
A SEL switch is set to "GTR".)
Phantom power : P48V (Phantom power ON/OFF is
selected in the "Input" menu of the
MENU mode.)

Insert [INSERT (input A only)]

Connector : 1/4-inch, TRS phone type
(Tip: output, Ring: input)
Nominal output level : -10dBV
Load impedance : 10k Ω or more
Nominal input level : -10dBV
Input impedance : 10k Ω or more

Stereo analog output [STEREO OUT (L, R)]

Connectors : 1/4-inch, phone type
Nominal output level : -10dBV (unbalanced)
Load impedance : 10k Ω or more

Headphones output [PHONES 1, 2]

Connectors : 1/4-inch, stereo phone type
Max. output power : 30mW or more (at 32 Ω load)
Load impedance : 16 Ω or more

MIDI output [MIDI OUT]

Connector : DIN 5-pin
Format : Conformed to the MIDI standard

Digital output [DIGITAL OUT]

Connector : Toslink optical type
Format : IEC 60958 (S/P DIF)

Footswitch [FOOT SW]

Connector : 1/4-inch, phone type
Level : TTL level

USB

Connector : B type (standard)

USB HOST

Connector : A type (standard)

[Record / playback]

Recording medium : 3.5-inch hard disk drive

Sampling frequencies: 44.1kHz

Quantization : 16-bits, linear (non expanded)

File format : FAT32

Audio recording type : Conformed to AES-31

The number of tracks : 8

* the number of simultaneously recordable tracks: 4

ADC : 24-bits, delta-sigma

DAC : 24-bits, delta-sigma

Frequency response : 20Hz to 20kHz

Dynamic range : 90dB or more (TYPICAL)

Total harmonic distortion : 0.06% or less (TYPICAL)

[General]

Weight (net) : Approx. 3.0 kg

Dimensions : 312 (W) x 264 (D) x 88 (H) mm

Power supply : 120VAC 60Hz, 230VAC 50/60Hz

Power consumption : 14W

Supplied Accessories : Power cord, Owner's Manual

* Changes in specifications and features may be made without notice or obligation.

[Pin assignment of XLR connectors]

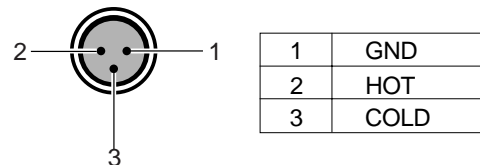

[Pin assignment of USB port]

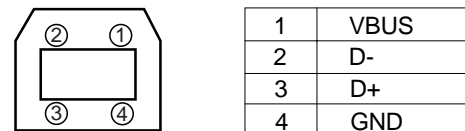

[Pin assignment of USB HOST port]

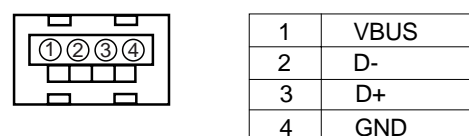

Physical dimensions

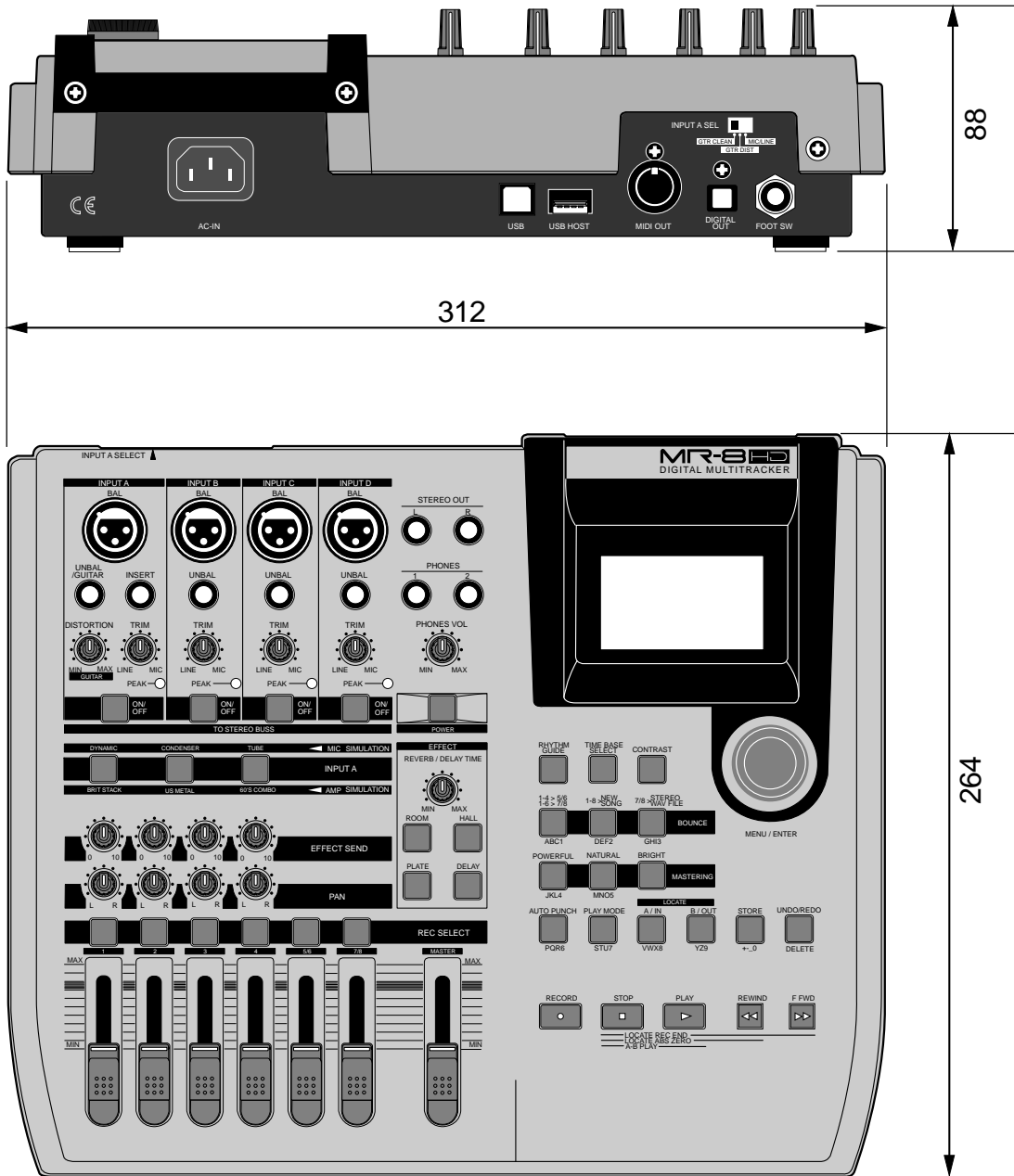

Block diagram

When using the normal mode

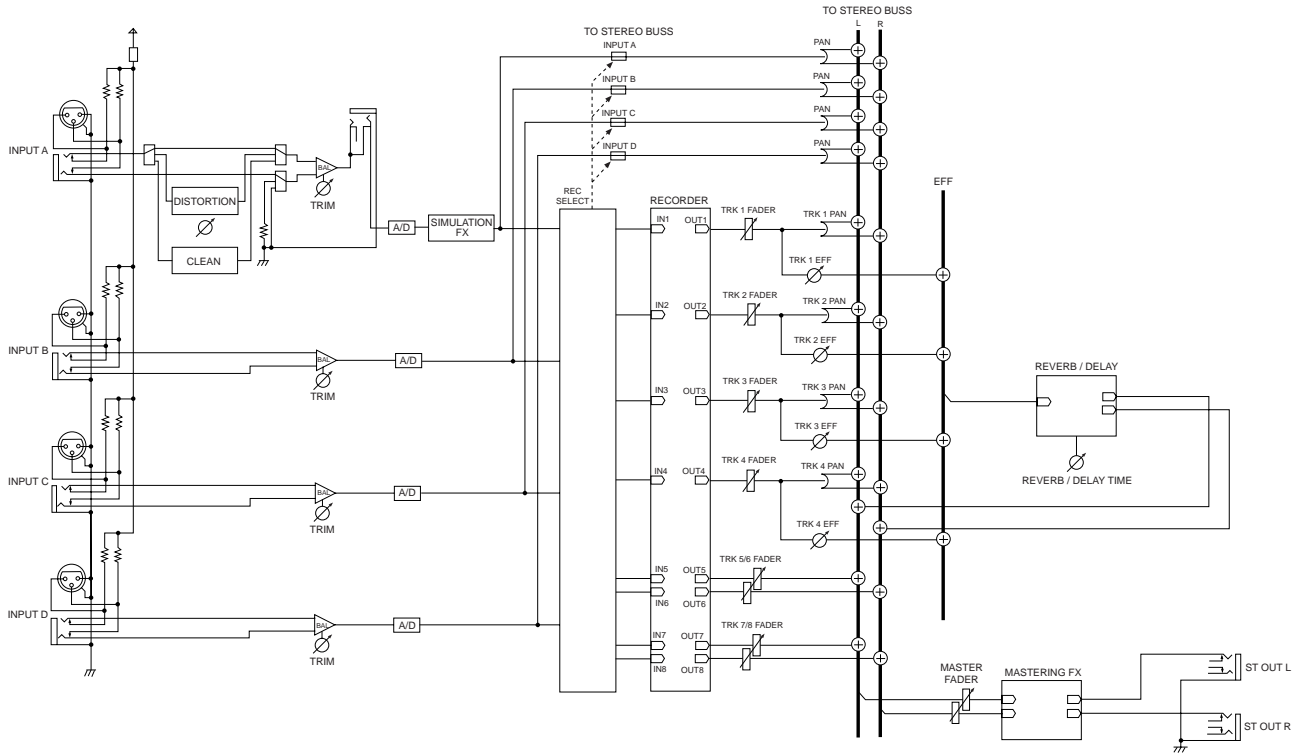

When using the bounce mode (1-4 > 5/6 mode)

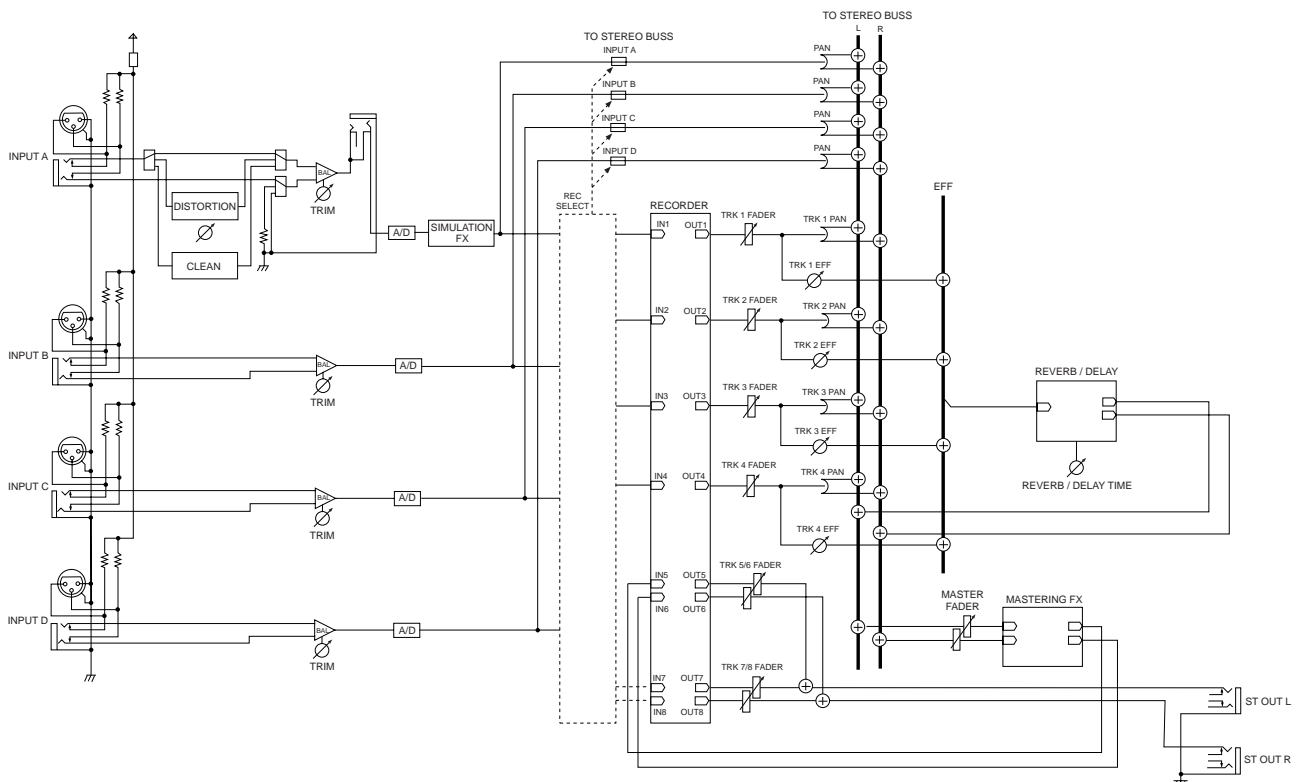

When using the bounce mode (1-6 > 7/8 mode)

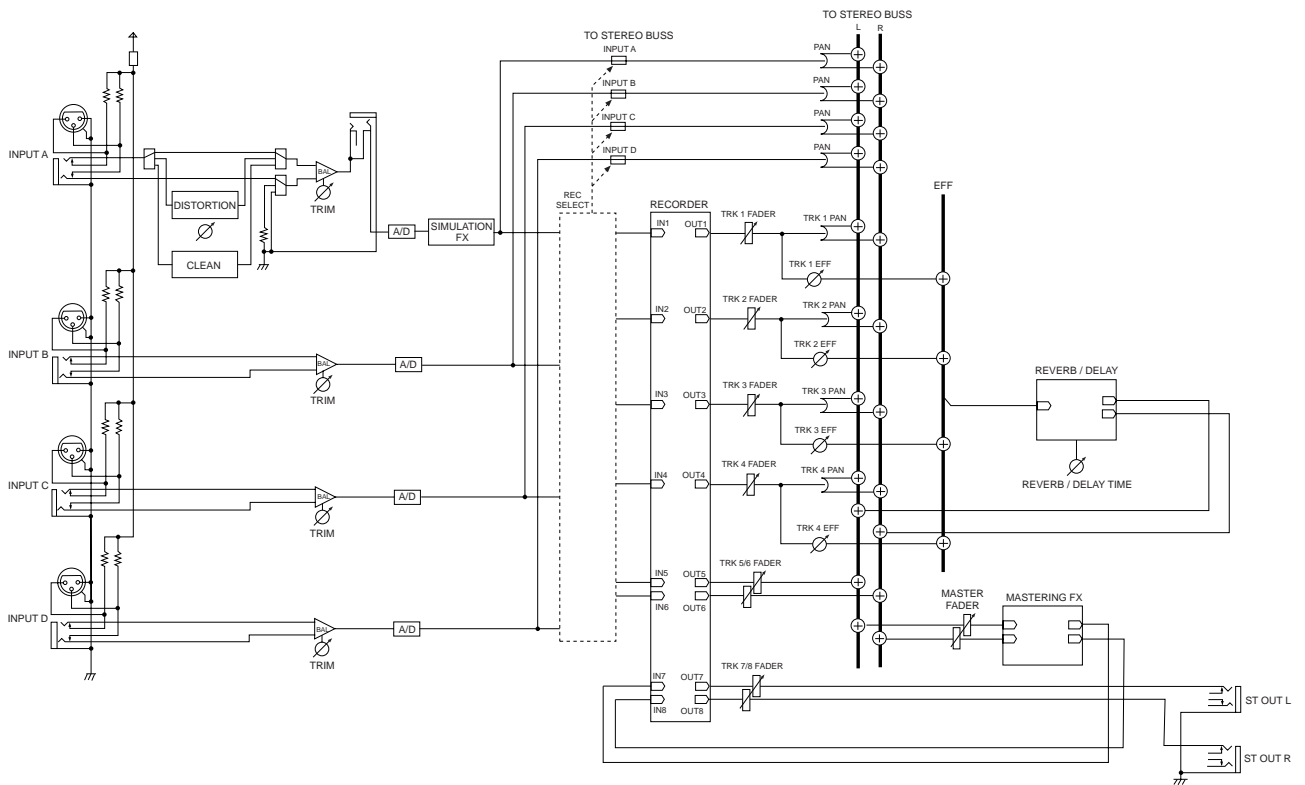

When using the bounce mode (1-8 > New Song mode)

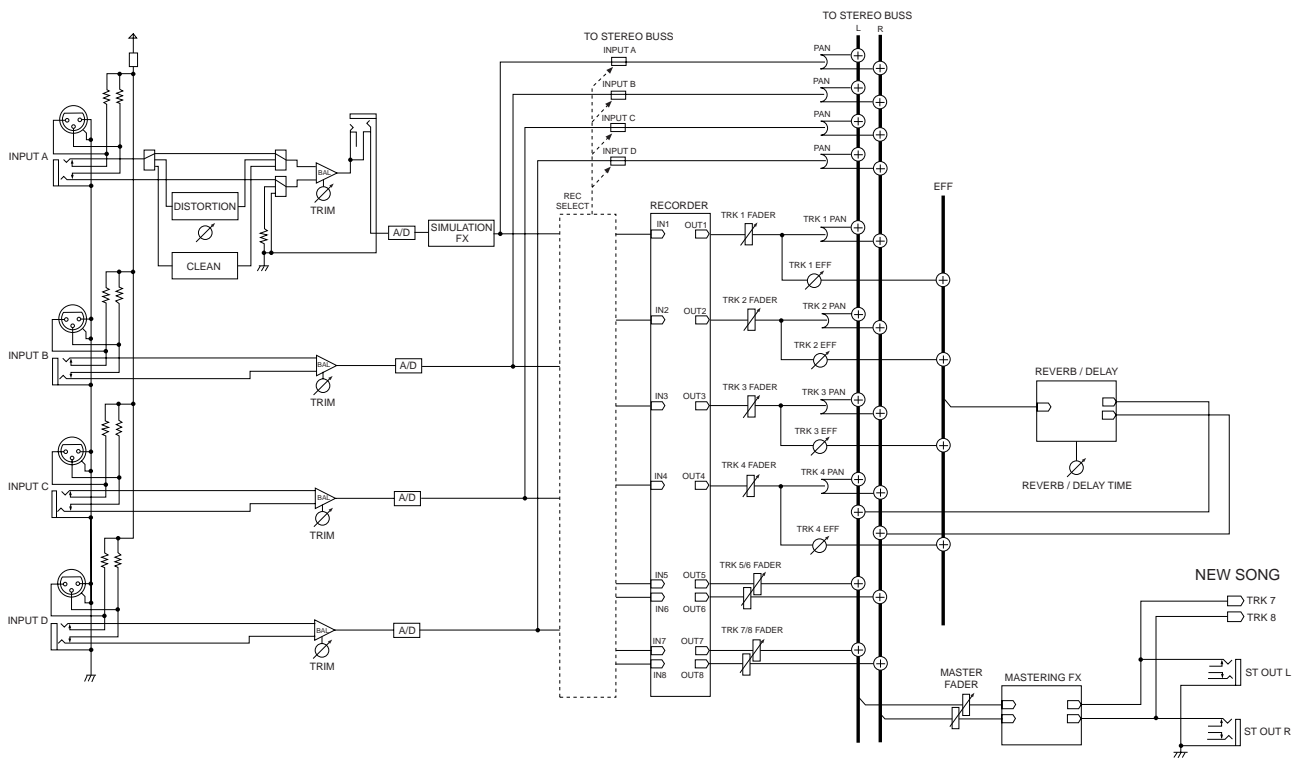

MIDI Implementation Chart

<Digital multitracker>

Model MR-8HD

Date:
Version: V1.00

Function.....	Transmitted	Recognized	Remarks
Basic Default	X	X	
Channel Changed	X	X	
Mode	Default	X	
	Message	X	
	Altered	*****	X
Note Number:	True Voice	*****	X
Velocity	Note ON	X	
	Note OFF	X	
After Touch	Key's	X	
	Channel's	X	
Pitch Bend	X	X	
Control Change	X	X	
Program Change:	True #	*****	X
System Exclusive	○ rem. 1	X	
Common	: Quarter Frame	○	X
	: Song Position	○	X
	: Song Select	X	X
	: Tune	X	X
System Real Time	: Clock	○	X
	: Commands	○ rem. 2	X
Aux. Message	: Local ON/OFF	X	X
	: All Notes OFF	X	X
	: Active Sense	X	X
	: Reset	X	X
Notes	rem.1 : MTC rem. 2 : START, STOP, CONTINUE		

Mode 1: OMNI ON, POLY
Mode 3: OMNI OFF, POLY

Mode 2: OMNI ON, MONO
Mode 4: OMNI OFF, MONO

○: Yes
X : No

Index

- <A>
 - Amp simulation58
 - Auto return45
 - Auto play45
 - ABS time14
 - Archiving a song95
 - Analog mixdown41
-
 - Bounce63
 - Bar/Beat14, 24, 127
 - Beginning a song14, 48
 - Bar offset81
- <C>
 - Cueing44
 - Clipboard116
 - Click level76
 - Clock87
 - Contrast24
 - Copy105, 114 to 118
 - Copyrights11
 - Conductor map78
 - Changing track108
 - Character entry key32, 99
 - Creating a song31
- <D>
 - Delay60
 - Distortion33, 35
 - Display23
 - Demo song29
 - Digital mixdown42
 - Delete song100
 - Damage11
- <E>
 - Effector57
 - Effect send61
 - Erasing track104
 - Erase part113
 - Event78 to 84
 - Exchange the track108
 - Exchange the parts121
- <F>
 - Format124
 - Foot switch53
- <G>
 - Gain15, 36, 38, 40
- <H>
 - Hard disk12, 124
 - Hidden file95, 100
- <I>
 - Insert effect58
 - Input A select switch33
 - Input monitor14, 36, 38, 40
 - Insert59
 - Input33
 - Initialize130
- <L>
 - Loop45
 - Locate48
- <M>
 - Master recorder41 to 42
 - Mastering effect62
 - Mic simulation58
 - MIDI85
 - MIDI implementation chart142
 - Mixdown41 to 42
 - Move107, 119
 - MENU mode25
- <O>
 - Overdubbing37
 - Offset81
 - Optical cable22, 42
- <P>
 - Playback36 to 42, 43
 - Power supply28
 - Power switch28
 - Personal computer89
 - Part111
 - Punch in/out51
 - Punch in/out points54
 - Play mode45
 - Pre roll47, 126
 - Peak LED15
 - Peak hold125
 - Phantom power128
 - Protect101, 94
 - Paste105, 114 to 118
 - Post roll47, 126
- <Q>
 - Quantization138
- <R>
 - Recording35 to 42
 - Recording level35 to 42
 - Recording track34
 - Recording method12
 - Reverb60
 - Redo36, 38, 40, 103, 113
 - Remain13, 35, 37, 39
 - Rehearsal55, 66, 68, 70
 - Repro monitor14
 - Resolution127
 - REC END12, 48
 - Rhythm guide75
- <S>
 - Signature75 to 80
 - Simulation58
 - Sequencer86
 - Signature map75 to 80
 - Standby mode28
 - Song13
 - Select a song98

Song name	32, 99	<U>	
Synchronization	85	Undo	36, 38, 40, 103, 113
Song protect	101	USB	92, 138
S/P DIF	42	USB HOST	22, 138
<T>		<W>	
Track	34	WAV file	13, 90
Trouble shooting	131	WAV file conversion	90
Trim	15, 35 to 40	Warning	25
Track fader	35 to 40	<Y>	
Time base	14, 24	Y cable	18, 59
Tempo map	82		

Declaration of EC Directive

This equipment is compatible with the EMC Directive (89/336/EEC) - Directive on approximation of member nation's ordinance concerning the electromagnetic compatibility and with the Low Voltage Directive (73/23/EEC) - Directive on approximation of member nation's ordinance concerning electric equipment designed to be used within the specified voltage range.

The Affect of Immunity on This Equipment

The affect of the European Specification EN61000-6-1 (coexistence of electromagnetic waves - common immunity specification) on this equipment are as shown below.

In the electrical fast transient/burst requirements, surge, conducted disturbances by radio-frequency fields, power frequency magnetic field, radiate electromagnetic field requirements and static electricity discharging environment, this could be affected by generation of noise in some cases.

FOSTEX DISTRIBUTORS LIST IN EUROPE

* Including non-EU countries (as of January, 2005)

<AUSTRIA>

NAME: ATEC Audio-u. Videogeraete VertriebsgesmbH.
 ADD: Im Winkel 5, A-2325 Velm, Austria
 TEL: (+43) 2234-74004, FAX: (+43) 2234-74074

<BELGIUM>

NAME: General Audio
 ADD: Raymond Pelgrimslaan 101, B-1702 Groot-Bijgaarden, Belgium
 TEL: (+32) 2-4630650, FAX: (+32) 2-4661500

<DENMARK>

NAME: SC Sound ApS
 ADD: Malervej 2, DK-2630 Taastrup, Denmark
 TEL: (+45) 4399-8877, FAX: (+45) 4399-8077

<FINLAND>

NAME: Norettron Oy Audio
 ADD: P. O. Box 22, FIN-02631 Espoo, Finland
 TEL: (+358) 9-5259330, FAX: (+358) 9-52593352

<FRANCE>

NAME: Sennheiser France
 ADD: 128 bis, avenue Jean-Jaures, 94851 Ivry-sur-Seine Cedex, France
 TEL: (+33) 1 4987 0300, FAX: (+33) 1 4987 0324

<GERMANY>

NAME: Mega Audio GmbH
 ADD: Stromberger Str. 32, D-55411 Bingen, Germany
 TEL: (+49) 6721-94330, FAX: (+49) 6721-32046

<GREECE>

NAME: Bon Studio S. A.
 ADD: 6 Zaimi Street, Exarchia, 106.83 Athens, Greece
 TEL: (+30) 210-3809-605, 606, 607, 608
 FAX: (+30) 210-3845-755, 210-3827-868

<ICELAND>

NAME: I. D. elrf. electronic Ltd.
 ADD: ARMULA 38 108 REYKJAVIK, ICELAND
 TEL: (+354) 588 5010, FAX: (+354) 588 5011

<ITALY>

NAME: Proel S. p. A.
 ADD: Zona Via Alla Ruenia, 37/43 64027 - Sant'Omero (Teramo), Italy
 TEL: (+39) 0861-81241, FAX: (+39) 0861-887862

<THE NETHERLANDS>

NAME: IEMKE ROOS AUDIO B. V.
 ADD: Kuiperbergweg 20, 1101 AG Amsterdam, The Netherlands
 TEL: (+31) 20-697-2121, FAX: (+31) 20-697-4201

<NORWAY>

NAME: Siv. Ing. Benum AS
 ADD: P.O. Box 145, Vinderen, 0319 Oslo, Norway
 TEL: (+47) 2213 9900, FAX: (+47) 2214 8529

<PORTUGAL>

NAME: Caius - Tecnologias Audio e Musica, Lda.
 ADD: Praca do Bom Sucesso, No 61 Bom Sucesso Trade Center, Escritorio 701/702, 4150-1460 Porto, Portugal
 TEL: (+351) 22-608-06-10, FAX: (+351) 22-608-06-29

<SPAIN>

NAME: Letusa S. A.
 ADD: C/Laguna 10, 28923 Alcorcon, Madrid, Spain
 TEL: (+34) 91-4862800, 91-4470898
 FAX: (+34) 91-6414597

<SWEDEN>

NAME: Sennheiser AB
 ADD: John Ericssonsgatan 10, P.O. Box 22035, SE-104 22 Stockholm, Sweden
 TEL: (+46) 8 566 16400, FAX: (+46) 8 566 16490

<SWITZERLAND>

NAME: Audio Bauer Pro AG
 ADD: Bernerstrasse-Nord 182, CH-8064 Zurich, Switzerland
 TEL: (+41) 1-4323230, FAX: (+41) 1-4326558

<UK>

NAME: SCV London
 ADD: 40 Chigwell Lane, Oakwood Hill Industrial Estate, Loughton, Essex IG10 3NY U. K.
 TEL: (+44) 20-8418-0778, FAX: (+44) 20-8418-0624

Fostex[®]

FOSTEX CO.

3-2-35, Musashino, Akishima-shi, Tokyo, Japan, 196-0021

FOSTEX AMERICA

13701 Cimarron Avenue Gardena, CA 90249 U.S.A.

© PRINTED IN CHINA JUNE 2005 8588062100

428387