

DIGITAL RECORDING STUDIO **D888**

Owner's Manual



KORG

E 1

IMPORTANT SAFETY INSTRUCTIONS

- Read these instructions.
- Keep these instructions.
- Heed all warnings.
- Follow all instructions.
- Do not use this apparatus near water.
- Mains powered apparatus shall not be exposed to dripping or splashing and that no objects filled with liquids, such as vases, shall be placed on the apparatus.
- Clean only with dry cloth.
- Do not block any ventilation openings. Install in accordance with the manufacturer's instructions.
- Do not install near any heat sources such as radiators, heat registers, stoves, or other apparatus (including amplifiers) that produce heat.
- Do not defeat the safety purpose of the polarized or grounding-type plug. A polarized plug has two blades with one wider than the other. A grounding type plug has two blades and a third grounding prong. The wide blade or the third prong are provided for your safety. If the provided plug does not fit into your outlet, consult an electrician for replacement of the obsolete outlet. (for U.S.A. and Canada)
- Protect the power cord from being walked on or pinched particularly at plugs, convenience receptacles, and the point where they exit from the apparatus.
- Only use attachments/accessories specified by the manufacturer.
- Unplug this apparatus during lightning storms or when unused for long periods of time.
- Turning off the power switch does not completely isolate this product from the power line so remove the plug from the socket if not using it for extended periods of time.
- Install this product near the wall socket and keep the power plug easily accessible.
- **WARNING**—This apparatus shall be connected to a mains socket outlet with a protective earthing connection.
- Refer all servicing to qualified service personnel. Servicing is required when the apparatus has been damaged in any way, such as power-supply cord or plug is damaged, liquid has been spilled or objects have fallen into the apparatus, the apparatus has been exposed to rain or moisture, does not operate normally, or has been dropped.
- Do not install this equipment on the far position from wall outlet and/or convenience receptacle.
- Do not install this equipment in a confined space such as a box for the conveyance or similar unit.
- Use only with the cart, stand, tripod, bracket, or table specified by the manufacturer, or sold with the apparatus. When a cart is used, use caution when moving the cart/apparatus combination to avoid injury from tip-over.



WARNING:
TO REDUCE THE RISK OF FIRE OR ELECTRIC SHOCK DO NOT
EXPOSE THIS PRODUCT TO RAIN OR MOISTURE.

	CAUTION RISK OF ELECTRIC SHOCK DO NOT OPEN	
AVERTISSEMENT: RISQUE DE CHOC ÉLECTRIQUE—NE PAS OUVRIR.		
注意 感電の恐れあり、キャビネットをあけるな		

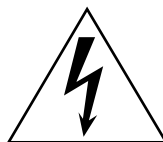

The lightning flash with arrowhead symbol within an equilateral triangle, is intended to alert the user to the presence of uninsulated "dangerous voltage" within the product's enclosure that may be of sufficient magnitude to constitute a risk of electric shock to persons.



The exclamation point within an equilateral triangle is intended to alert the user to the presence of important operating and maintenance (servicing) instructions in the literature accompanying the product.

CAUTION

Danger of explosion if battery is incorrectly replaced.
Replace only with the same or equivalent type.

THE FCC REGULATION WARNING (for U.S.A.)

This equipment has been tested and found to comply with the limits for a Class B digital device, pursuant to Part 15 of the FCC Rules. These limits are designed to provide reasonable protection against harmful interference in a residential installation. This equipment generates, uses, and can radiate radio frequency energy and, if not installed and used in accordance with the instructions, may cause harmful interference to radio communications. However, there is no guarantee that interference will not occur in a particular installation. If this equipment does cause harmful interference to radio or television reception, which can be determined by turning the equipment off and on, the user is encouraged to try to correct the interference by one or more of the following measures:

- Reorient or relocate the receiving antenna.
- Increase the separation between the equipment and receiver.
- Connect the equipment into an outlet on a circuit different from that to which the receiver is connected.
- Consult the dealer or an experienced radio/TV technician for help.

Unauthorized changes or modification to this system can void the user's authority to operate this equipment.

CE mark for European Harmonized Standards

CE mark which is attached to our company's products of AC mains operated apparatus until December 31, 1996 means it conforms to EMC Directive (89/336/EEC) and CE mark Directive (93/68/EEC). And, CE mark which is attached after January 1, 1997 means it conforms to EMC Directive (89/336/EEC), CE mark Directive (93/68/EEC) and Low Voltage Directive (73/23/EEC). Also, CE mark which is attached to our company's products of Battery operated apparatus means it conforms to EMC Directive (89/336/EEC) and CE mark Directive (93/68/EEC).



Handling of the internal hard disk

Do not apply physical shock to this device. In particular, you must never move this device or apply physical shock while the power is turned on. This can cause part or all of the data on disk to be lost, or may damage the hard disk or interior components.

When this device is moved to a location where the temperature is radically different, water droplets may condense on the hard disk. If the device is used in this condition, it may malfunction, so please allow several hours to pass before operating the device.

Do not turn the power on and off repeatedly. This may damage the D888.

This device begins to access the hard disk immediately after the power is turned on.

Never turn off the power while the HDD access indicator is lit or blinking. Doing so can cause all or part of the data on hard disk to be lost, or may cause malfunctions such as hard disk damage.

If the hard disk has been damaged due to incorrect operation, power failure, or accidental interruption of the power supply, a fee may be charged for replacement even if this device is still within its warranty period.

Data handling

Incorrect operation or malfunction may cause the contents of memory to be lost, so we recommend that you save important data on a CD or other media. Please be aware that Korg will accept no responsibility for any damages which may result from loss of data.

Also, when digitally recording copyrighted audio material from a DAT or CD etc., you must obtain permission for use. Please be aware that Korg will accept no responsibility for any copyright violations which may occur through your use of this product.

COPYRIGHT WARNING

This professional device is intended only for use with works for which you yourself own the copyright, for which you have received permission from the copyright holder to publicly perform, record, broadcast, sell, and duplicate, or in connection with activities which constitute "fair use" under copyright law. If you are not the copyright holder, have not received permission from the copyright holder, or have not engaged in fair use of the works, you may be violating copyright law, and may be liable for damages and penalties. If you are unsure about your rights to a work, please consult a copyright attorney. **KORG TAKES NO RESPONSIBILITY FOR ANY INFRINGEMENT COMMITTED THROUGH USE OF KORG PRODUCTS.**

Printing conventions in this manual

Faders, knobs, and keys on the panel

In this manual, "faders," "knobs," and "buttons" refer to controls on the panel. The names shown on the panel are printed in **boldface** in the manual.

Examples: **MASTER fader**, **TRIM knob**, **REC/PLAY button**

Items in the LCD screen

This manual uses "**bold**" type to indicate parameters and values shown in the LCD screen.

Examples: "**Repeat**", "**T1**", "**60**"

Steps 1) 2) 3) ...

Steps in a procedure are indicated as 1) 2) 3) ...

(→p.■■■)

This indicates a reference page within this manual.



These symbols respectively indicate points of caution or notes of advice.

LCD screens

The parameter values shown in the LCD screens printed in this manual are explanatory examples, and may not necessarily match the displays that appear on your D888.

* Company names, product names, and names of formats etc. are the trademarks or registered trademarks of their respective owners.

Table of Contents

Introduction	6	Operation	20
Included items.....	6	Level Meter screen	20
Before using the D888 for the first time	6	1. Display content and settings.....	20
Power on/standby/off	6	1-1. Peak Hold setting.....	20
Connection example.....	7	1-2. Level meter position	20
Main features	8	1-3. Switching the counter display	20
Parts and their function	9	1-4. Other Indicators.....	20
Top panel	9	Song and Location	21
Rear panel.....	12	1. Song	21
Screens and operations	13	1-1. Creating a new song.....	21
 		1-2. Selecting an existing song	21
Basic operation	14	1-3. Renaming a song.....	21
1: Setup and listening to the demo song	14	1-4. Controlling a song	21
1-1. Checking and connections	14	2. Location	22
Connecting your monitoring equipment.....	14	2-1. Moving the location	22
1-2. Turn the D888 on	14	Using the counter to move.....	22
1-3. Listen to the demo song	15	Using the FF and REW buttons to move ...	22
Listening to the demo song again from the	15	Moving to the beginning/end	22
beginning.....	15	of the song	22
2: Recording	15	Using marks to move.....	22
2-1. Creating a new song	15	Mixer	24
2-2. Connecting your input device	16	1. Mixer inputs	24
2-3. Start recording	16	1-1. Connecting audio sources.....	24
3: Playback	16	Keyboard or line output device	24
3-1. Listening to the playback	16	Guitar or bass.....	24
3-2. Adjusting the playback sound.....	16	Mic.....	24
4: Overdubbing	17	1-2. Adjusting the input level.....	24
4-1. Connecting your input device.....	17	1-3. Adjusting the monitor level	24
4-2. Start recording	17	2. Mixer outputs	24
4-3. Listening to the song.....	17	2-1. When MST/MON is selected.....	24
5: Mixdown and mastering	18	2-2. When INDIVIDUAL is selected	25
5-1. Adjusting the tone and volume	18	3. Adjusting the mixer	25
of each track.....	18	3-1. Adjusting the volume	25
5-2. Start recording	18	Adjusting the volume level	25
5-3. Listen to your song	18	of each channel	25
5-4. Saving your song	19	Adjusting the overall volume level	25
6: Structure	19	3-2. Adjusting the pan	25
		3-3. EQ (Equalizer).....	25
		3-4. Muting a channel.....	25
		4. Metronome.....	25
		Recording (basic)	26
		1. Virtual tracks.....	26
		1-1. Selecting virtual tracks	26
		1-2. Track display	26

2. Types of recording	26	5. Connecting to a computer	41
2-1. Recording channel tracks	27	5-1. USB mode	42
2-2. Overdub recording	27	5-2. Files you can use.....	42
2-3. Bounce recording	27	6. Synchronization via MIDI	43
2-4. Recording the master track	28	6-1. MIDI connections.....	43
Recording (advanced).....	29	6-2. MIDI messages used by the D888	43
1. Re-recording	29	6-3. MIDI synchronization settings	43
1-1. Punch-in Recording (Re-recording a specific area).....	29	7. Upgrading the system.....	43
Manual punch-in/out.....	29	7-1. Downloading the operating system....	43
Auto punch-in/out.....	29	7-2. Updating the system	43
1-2. Repeat recording.....	30	Appendices	44
2. Recording-related functions	31	Troubleshooting.....	44
2-1. Rehearsal function.....	31	Power does not turn on.....	44
2-2. Auto input.....	31	Nothing appears in the display	44
Automatically switching between recording and playback	31	Vertical lines are visible in the display	44
Turning auto input on/off	31	No sound	44
Playback	32	Can't record	44
1. Types of playback.....	32	The input or recorded sound is noisy or distorted.....	44
1-1. Playing the channel tracks	32	Effects do not apply	44
1-2. Playing a master track.....	32	Metronome.....	44
1-3. Repeat playback	32	A button does not function when pressed.....	45
Effects.....	33	MIDI.....	45
1. Using an effect.....	33	Audio files.....	45
2. Effect programs and parameters.....	33	USB.....	45
3. Saving effect settings.....	34	Various messages.....	45
Editing.....	35	Confirmation messages.....	46
1. Song editing	35	Serious error messages.....	46
1-1. Reloading a song	35	File details.....	47
1-2. Deleting a song	35	The structure of the D888's hard drive	47
1-3. Copying a song.....	35	WAV files that can be used on the D888	47
1-4. Saving a song	36	Song file details.....	48
1-5. Protecting a song	36	Settings common to all songs.....	48
2. Track editing.....	37	Settings stored independently for each song.....	48
2-1. Copy a track (Copy)	37	Block diagram	48
2-2. Erase a track (Erase).....	38	Demo Song	48
2-3. Exchanging tracks (Swap).....	38	Specifications	49
2-4. Selecting a master track file (Master)	39	Index	50
2-5. Selecting a channel track file (VTrack)	39	MIDI implementation chart	51
2-6. Deleting track data (Delete).....	40		
Other	40		
1. Adjusting the contrast.....	40		
2. Using a foot switch.....	40		
3. Undo and Redo.....	41		
4. Formatting the drive.....	41		

Introduction

Thank you for purchasing the Korg **D888 Digital Recording Studio**. To take full advantage of the D888's functions, and to enjoy trouble-free use, please read this manual carefully and use this product only as directed. Keep this manual in a safe place for future reference.

Included items

Make sure that the following included items are present.

- Owner's Manual (this document)
- Power cable

Before using the D888 for the first time

Important

Please observe the following points when using the D888.

Power on/standby/off

The D888 is a precision instrument, similar to a personal computer, equipped with an internal hard disk drive. When turning the power on and off, follow the procedures shown below to protect your D888, your data, and your other equipment.

⚠ Before you turn on the power, make sure that the power cable is firmly plugged into the D888 and into an AC outlet.

● Power-on

- 1) Lower the D888's monitor LEVEL knob to the "0" position. Set the volume controls of your external equipment to their lowest position.
- 2) Turn on the power of external input devices such as keyboards that are sending audio to the D888.
- 3) If the main power switch (POWER ON) located on the rear panel of the D888 is off, turn it on. The STANDBY LED will light. The D888 is now in the "standby" mode.

⚠ A certain amount of time will be required from when you turn on the main power until the STANDBY LED lights.

- 4) Press the power (ON) button located on the top panel to turn the D888 on.

The opening screen will appear in the display, and then the Level Meter screen will appear.

⚠ If the USB cable is connected to your computer when you turn on the power, the USB screen will appear and the D888 will enter USB mode (→p.42).

When you turn the power on, the selected song will be the same song that had been selected when the D888 was shut down.

- 5) Now you can turn on your monitoring system (or any other external device) that is receiving audio from the D888.

⚠ If the power is turned off accidentally while the D888 is being used, the D888 itself or its internal hard disk drive may be damaged.

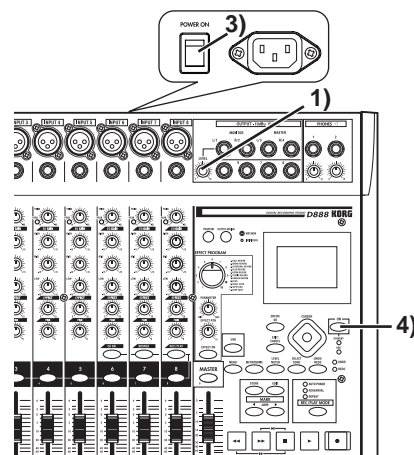

The opening screen (D888)



● Shutdown

- 1) Lower the D888's monitor LEVEL knob to the "0" position.
- 2) Turn off any devices connected to the D888's outputs, such as your monitor system.
- 3) Hold down the D888's power (ON) button (for 2–3 seconds) and the shutdown LCD screen appear.

If you press the **ENTER/OK** button, the current song will be saved automatically, and the D888 will return to the standby mode. This process is called "**shutdown**".

If you press the **EXIT/CANCEL** button, you will return to the previous screen.

Shut Down:
Are you sure?
OK or CANCEL

● Power -off

- 1) If you will not be using the D888 for an extended period of time, press the main power switch (**POWER ON**) located on the rear panel of the D888 to turn off the power.
- 2) Turn off any devices (such as keyboards) connected to the D888's inputs.

- ⚠ When turning the power off, you must perform the shutdown process. Never turn off the main power switch or disconnect the power cable before shutdown has been completed.
- ⚠ If you turn off the main power switch or disconnect the power cable before shutdown has been completed, data or user settings will be lost, and the hard disk may be damaged.
- ⚠ The audio you record into the D888 and the mixer and effect settings you make are automatically saved when you select a song or perform the shutdown process.

Connection example

This diagram shows typical connections when using the D888. Connect your equipment as appropriate for your system.

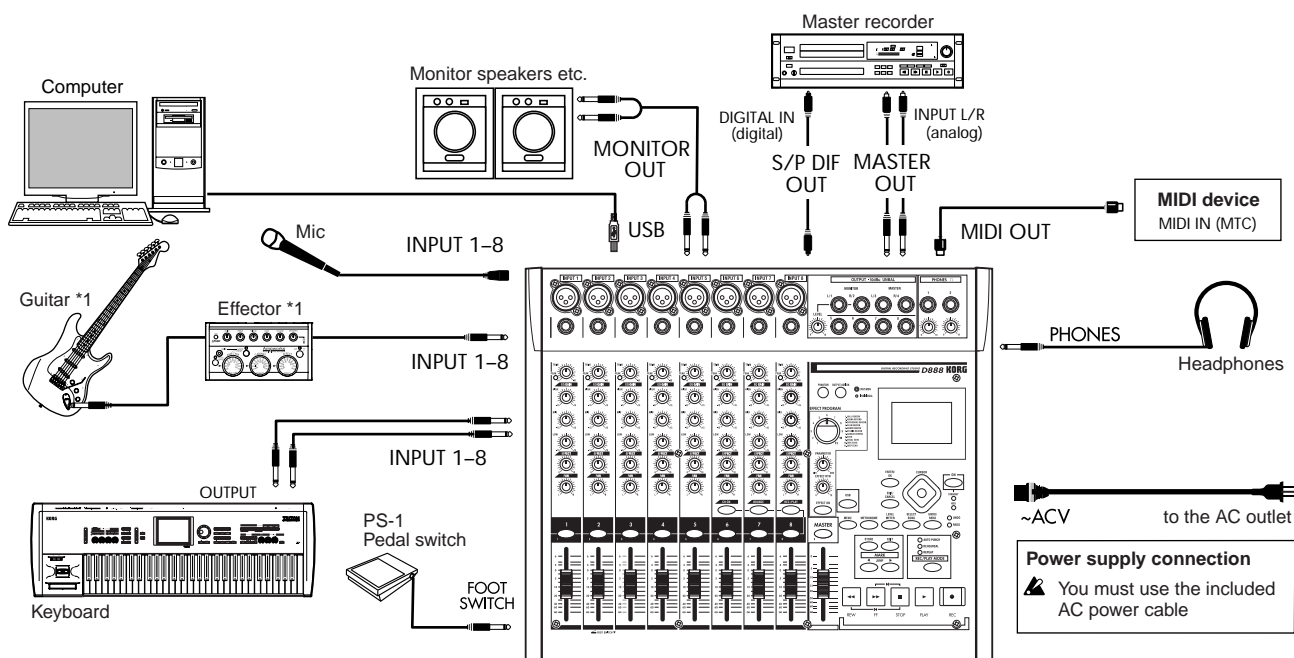

*1: You can directly input a guitar or bass that has active pickups, but if your instrument has passive pickups (i.e., without a built-in preamp), you won't obtain satisfactory volume and tone quality because of the impedance mismatch. In this case, please route your instrument through a preamp or effect unit.

Main features

◆ 8-track digital multi-track recorder

The D888 features 40-bit internal processing and allows you to simultaneously record up to eight tracks of high-quality 16-bit 44.1 kHz uncompressed audio. Each track provides eight virtual tracks. Each track (and virtual track) is recorded as a WAV file, so it can easily be shared with DAW software and other recorders.

A master track file (stereo WAV) is created each time you record the master track, so you can master your song repeatedly until you are satisfied, and choose the best version later.

◆ Eight analog input jacks offering your choice of TRS phone or +48V phantom-powered XLR connectors

All of the D888's analog inputs use high-performance balanced pre amps to take full advantage of its high-quality full-digital audio processing.

The phone jack inputs are all TRS balanced types. Unbalanced input is also supported, allowing you to directly connect a variety of audio sources.

The eight XLR input jacks provide +48V phantom power, allowing the easy use of both condenser and dynamic mics.

◆ Analog-like operation

The mixer section is laid out in the familiar style of an analog mixer, providing eight channel strips each offering input jacks, TRIM knob, EQ GAIN knobs, EFFECT knob, PAN knob, channel button, and channel fader so that operation is quick and intuitive.

◆ Effects

The Effect section provides 40-bit processing and 11 types of effects. The effect parameters can be edited, and these edits can be saved as part of your song.

◆ Editing functions

Non-destructive digital editing allows you to perform various edits without impairing the high-quality sound. In addition to punch-in/out recording, the D888 also provides Undo and Redo functions that let you listen to the “before” and “after” versions of any edit to assure you achieve the results you desire. Track editing functions such as Copy and Swap are also provided.

You can register one hundred mark points per song, making it easy to move quickly to desired locations in your song for editing.

◆ Internal hard disk drive

A high-capacity hard disk drive is built-in, providing approximately three hours of recording time per GB (single track recording).

◆ High-speed USB 2.0 connection

The high-speed USB 2.0 connector makes it easy to exchange track (WAV) data with a computer.

◆ Rehearsal function

You can rehearse mixer operations and settings in exactly the same way as when recording but without occupying hard disk space (i.e., without actually recording your operations).

◆ Flexible output switching

With the touch of a button, the individual outputs provided for each channel can be re-configured to provide stereo Master outputs, stereo Monitor outputs, and individual outputs for channels 5-8.

◆ Metronome

The convenient metronome can be switched between the master + monitor outputs, or routed to just the monitor output.

5 PAN knobs

These knobs adjust the pan (position in the stereo field) of each channel.

6 CHANNEL buttons (1–8)

These buttons switch the status of each channel.

CH ON: Use these buttons to switch the channels between enabled and disabled (muted). The button will be lit (orange) for channels that are enabled.

BOUNCE: Use these buttons to switch the status of the channel when bounce recording. The bounce-destination (the channel to be recorded) will blink red, and the bounce-sources (the playback channels) will be lit green.

REC/PLAY: Use these buttons to switch between recording and playback for each channel. (Red for recording, green for playback.)

note You can also use these buttons as the “1–8” buttons for numeric input (→p.21, 35).

7 Channel faders (1–8)

These adjust the volume that is sent from each channel to the master bus.

8 FOOT SWITCH jack

By connecting a foot switch (we recommend the separately sold KORG PS-1 pedal switch) you can use it to punch-in/out when performing manual punch recording (→p.29, 40).

9 CH ON button

When this button is on (lit orange), you can use the **channel buttons** to switch each channel between enabled and disabled. You can also use this as a mute function.

10 BOUNCE button (0)

When this button is on, you can use the **channel buttons** to specify each channel as a bounce destination (record) or bounce-source (playback).

note You can also use this button as the “0” button for numeric input (→p.21, 35).

11 REC/PLAY button

When this button is on (lit), you can use the **channel buttons** to switch each channel of the track recorder between recording and playback. The track setting will alternate each time you press a **channel button**. If the master track’s **channel button** is in Play mode all other tracks will automatically be muted (silent), and if it is in Record mode all other tracks will automatically be in Play mode.

12 MASTER fader

This adjusts the overall volume. When you’re recording the master track, this sets the recording level.

note When recording, you will normally leave the **MASTER fader** at 0 dB and adjust the channel faders so that the output does not distort.

13 MASTER button (9)

As you repeatedly press this button, the master track will cycle between Record (lit red), Play (lit green), and Off (dark).

note You can also use this button as the “9” button for numeric input (→p.21, 35).

14 Transport buttons

Use the **REC button**, **PLAY button**, **STOP button**, **REW button**, and **FF button** to perform recorder operations such as playback and recording (→p.21).

15 Monitor LEVEL knob

If the **OUTPUT ASSIGN (19) button** is set to “MST/MON” this knob will adjust the output volume of the **MONITOR L,R** jacks; if the button is set to “INDIVIDUAL” this knob will adjust the volume of the **OUTPUT** jacks for mixer channels 1 and 2.

16 OUTPUT jacks

You can connect external devices to these jacks. The audio signals sent from these jacks will depend on the setting of the **OUTPUT ASSIGN (19)**. These are unbalanced outputs that accommodate 1/4" phone jacks.

MST/MON

The audio output of the MASTER L,R, MONITOR L,R, and mixer channels 5, 6, 7, and 8 will be sent from the OUTPUT jacks.

INDIVIDUAL

The audio output of mixer channels 1, 2, 3, 4, 5, 6, 7, and 8 will be sent from the OUTPUT jacks.

17 PHONES jacks and level knobs

You can connect two sets of headphones here and use the respective knob to adjust the volume level. These are 1/4" stereo phone jacks that carry the same audio as the MONITOR jacks.

18 PHANTOM button

The XLR jacks for INPUT 1–8 provide a +48V phantom power supply for use with condenser mics. Pressing this button will toggle between the phantom power being on (button lit) or off (button dark). Always observe caution when using phantom power. In certain cases, you can mix condenser microphones and balanced dynamic microphones (usually those with a detachable cable and an XLR connector) when using phantom power. Unbalanced dynamic microphones must never be connected to the XLR inputs when phantom power is on. In most cases, unbalanced dynamic microphones are connected to the 1/4" inputs, avoiding this issue.

⚠ *Phantom power will not be supplied to INPUT jacks to which a TRS phone plug is connected.*

⚠ *If a condenser mic is connected or disconnected while the PHANTOM button is on, damage to your equipment may occur. For this reason, always turn the phantom power switch off before connecting or disconnecting a condenser mic.*

⚠ *If the PHANTOM button is on, you must never connect any device other than a condenser mic. Doing so may damage your equipment.*

19 OUTPUT ASSIGN button

This selects the audio signals that will be sent from the OUTPUT (16) jacks. Each time you press this button, the setting will alternate between MST/MON (button lit) and INDIVIDUAL (button dark) (→p.24).

20 Display

This shows the song name, recording or playback volume (level meters), time information (locations), and parameters.

21 ON button, STANDBY LED

This button turns the D888's power on/off. When the STANDBY LED is lit, you can press the ON button to turn on the power.

When the D888 is operating, you can hold down the ON button to display the shutdown screen.

22 HDD LED

This will light when the hard drive is being accessed during recording, playback, or editing, etc.

⚠ *Never power-off the D888 or subject it to vibration or physical shock while the HDD LED is lit or blinking.*

23 EFFECT selector

This is used to select the program that the effect processor will use.

24 PARAMETER knob

This is used to adjust the parameter values of the selected effect.

25 EFFECT RTN knob

This adjusts the depth of the effect.

26 EFFECT ON button

Each time you press this button, the effect will alternate between on (button lit) and off (button dark).

27 ENTER/OK button, EXIT/CANCEL button

Press the ENTER/OK button to confirm or execute an operation and proceed to the next screen. Press the EXIT/CANCEL button to halt or cancel an operation and return to the previous screen.

These buttons are also used in response to messages that appear in the screen.

28 Cursor buttons

Use these buttons to perform operations in the screen, such as selecting parameters, moving between screens, or editing values.

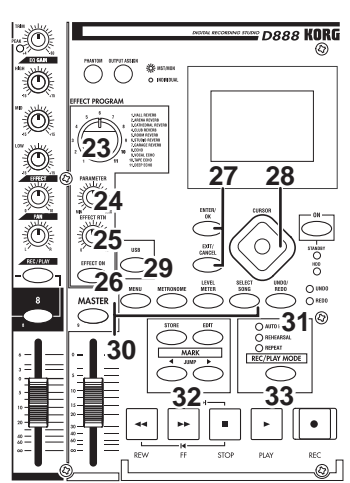

29 USB button

Press this button to enter USB mode.

30 MENU button, METRONOME button, LEVEL METER button, SELECT SONG button

Press one of these mode buttons to enter the edit menu, metronome settings, level meters, or song select screen.

31 UNDO/REDO button, LED

When this LED is lit, you can press this button to undo or redo the previous operation.

32 STORE button, EDIT button, ◀ JUMP button, JUMP ▶ button

Press the **STORE button** to register a song location as a “mark,” and press the **EDIT button** to access the edit screen where you can view a list of marks and jump to a desired mark (or delete an unwanted mark). You can press the **◀ JUMP button** or **JUMP ▶ button** to sequentially step through the stored marks before or after the current location.

33 REC/PLAY MODE button, AUTO PUNCH, REHEARSAL, REPEAT LEDs

Use this button to specify the recording or playback mode. The corresponding LED will light to indicate when auto punch recording is on, when rehearsal is on, or when repeat playback is on.

Rear panel

1 USB connector

You can use a USB cable to connect the D888 to your computer.

⚠ *USB peripheral devices such as external hard disks and CD-R/RW drives cannot be connected to the D888.*

⚠ *If the USB cable is connected to your computer when you turn on the power, the USB screen will appear and the D888 will enter USB mode (→p.42).*

2 MIDI OUT connector

MIDI Time Code (MTC; 30 NDF) messages are transmitted from this connector. Use this when you wish to synchronize an external device to the D888 via MIDI (→p.43).

3 S/P DIF OUT jack

This is an optical-type S/P DIF format (IEC60958, EIAJ CP-1201) digital output jack (stereo). Use an optical cable to connect this jack to the optical digital input of your CD-RW, MD or other equipment.

This output provides the same audio information as the **MASTER L/R** jacks, but in a digital format.

4 Main power switch (POWER ON)

This turns the main power on/off.

When the Main power switch is turned on, the D888 will enter the standby mode.

In the standby mode, pressing the **ON button** will turn the D888 on. While the D888 is operating, hold the **ON button** down to access the **Power Off** dialog box and select **Yes** to shutdown the D888 and return to the standby mode. Then you can use the main power switch to turn the power off completely.

⚠ *To turn off the power, you must first press the **ON button** to perform the shutdown operation. Never turn off the Main power switch or disconnect the power cable until shutdown has been completed. If you turn off the Main power switch or disconnect the power cable before shutdown has been completed, data and user settings may be lost, and the hard disk may be damaged.*

5 AC connector

Connect the power supply cable (included) here.

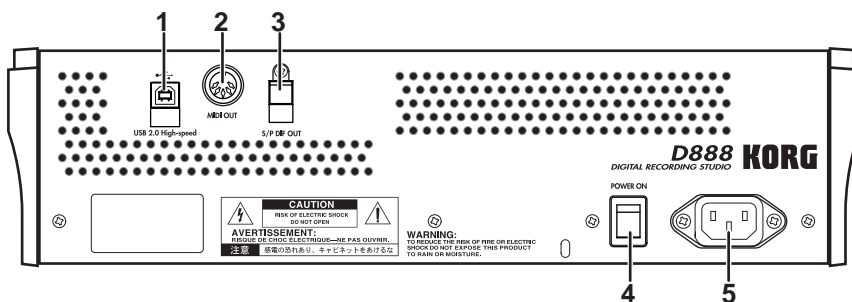

Screens and operations

1 Selecting a mode screen

Press a mode button (**MENU**, **METRONOME**, **LEVEL METER**, etc.) to access the corresponding screen in the display.

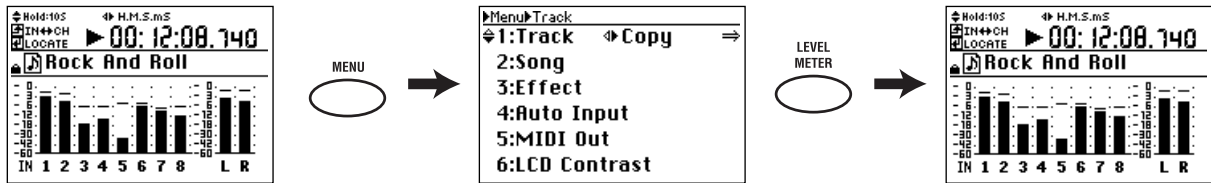

2 Selecting a parameter and editing its value

In screens that allow editing, you will mainly use the **cursor buttons**, **ENTER/OK button**, and **EXIT/CANCEL button** to select a parameter and edit its value. However for some screens and parameters, you can use the **channel buttons** and the **BOUNCE** and **MASTER buttons** to enter numeric values. An indication of \blacklozenge in the screen means that you can use the up/down cursor buttons to select or make settings, and an indication of \blacktriangleleft means that you can use the left/right cursor buttons. The \Rightarrow indication means that you can press the **ENTER/OK button** to proceed to the next screen. To confirm the settings you edited, press the **ENTER/OK button** to return to the preceding screen. Alternatively, you can press the **EXIT/CANCEL button** to discard any changes you made, and return to the preceding screen with the existing settings unchanged.

Changing the Auto Input setting from “On” to “Off”

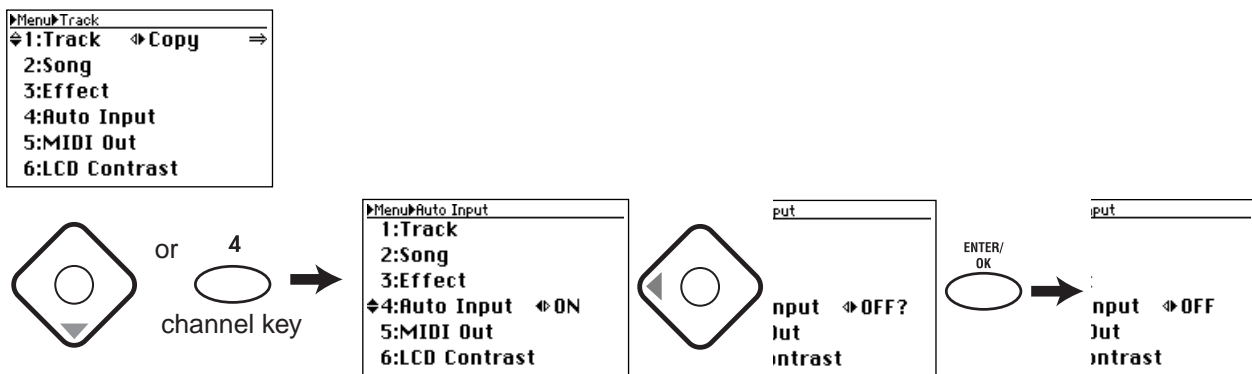

If the screen indicates \Rightarrow

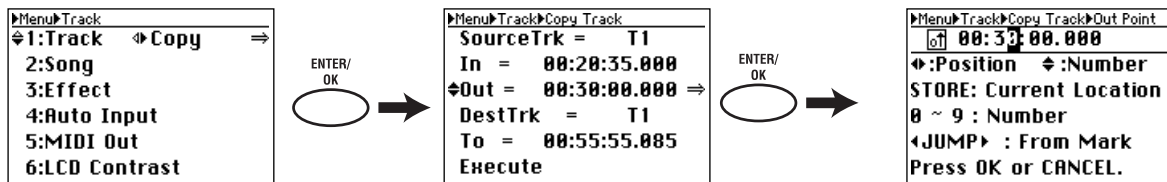

Finalizing the change (ENTER/OK) or discarding the change (EXIT/CANCEL)

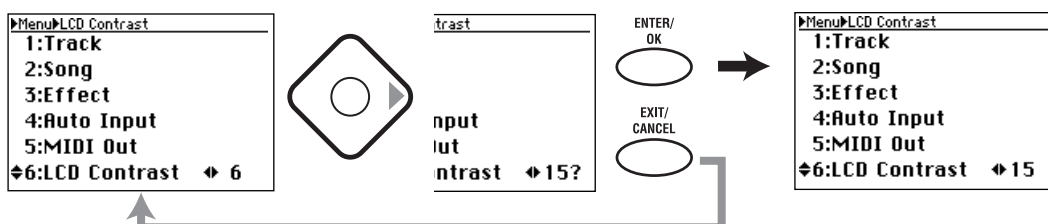

Basic operation

1: Setup and demo songs

Connect your monitor speakers or headphones, and turn on the power. Before you start recording your own songs, take a minute to listen to the demo song provided with the D888.

2: Recording

Connect your keyboard, mic, guitar, or other instrument, and record your performance on a channel track.

3: Playback

Play back your recorded performance, and apply EQ and effects.

4: Overdubbing

While listening to the performance you recorded in step 2, record additional performances on other channel tracks.

5: Mixdown and mastering

Apply effects and EQ to the performances of all tracks to create the overall balance you want.

Adjust the overall level and pan, and record your mix onto the master track.

6: Structure

Take a look at a simple block diagram that shows the audio signal flow of the D888's recorder.

1: Setup and listening to the demo song

1-1. Checking and connections

Connecting your monitoring equipment

- 1) Either connect your monitor system to the MONITOR L,R jacks, or connect your headphones to the PHONES jack.
- 2) Turn the monitor LEVEL knob to "0". If you connected headphones, turn the PHONE level knob all the way toward the left.

⚡ If the **OUTPUT ASSIGN** button is dark (INDIVIDUAL), press the button to make it light (MST/MON).

1-2. Turn the D888 on

Connect the AC power cable (included), and turn on the power. Be sure to use the procedure described in p.6 "● Power-on".

⚡ Use an independent AC outlet whenever possible. If a circuit breaker should trip for some reason, any unsaved data will be lost and the internal hard drive may be damaged.

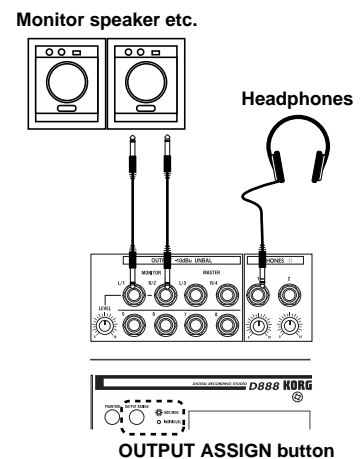

1-3. Listen to the demo song

When shipped from the factory, the D888 contains a pre-recorded demo song.

- 1) **Make sure that the display shows the demo song.**
If something other than the demo song is shown, select the demo song as described in p.21 “1-2. Selecting an existing song”.
- 2) **Set the channel faders and the Master fader to “0”.**
- 3) **Press the PLAY button to begin playing the demo song.**
- 4) **Slowly turn the monitor LEVEL knob toward the right to adjust the playback volume.**
If you connected headphones, turn the PHONES level knob slowly toward the right to adjust the volume.
- 5) **When the demo song ends, press the STOP button to stop playback.**

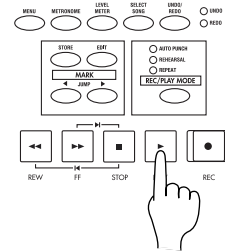
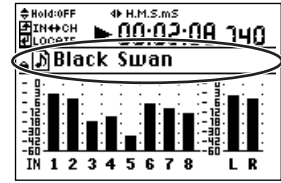

1: Setup and listening to the demo song

2: Recording

Listening to the demo song again from the beginning

- 1) **Hold down the STOP button and press the REW button to return to the beginning of the demo song.**
- 2) **Press the PLAY button to begin playing the demo song from the beginning.**

Basic operation

2: Recording

Now let's connect a two-channel (stereo) audio source such as a keyboard, and record it.

2-1. Creating a new song

Here's how to create a new song for recording.

- 1) **Press the SELECT SONG button to access the Select Song screen.**
- 2) **Use the cursor left/right buttons to select New, and press the ENTER/OK button.**
The screen will ask “New Song: Are you sure?”
- 3) **Press the ENTER/OK button to begin creating the new song.**
- 4) **When the song has been created, a song named “Song****” will be added (**** will be a consecutive number starting with 1).**

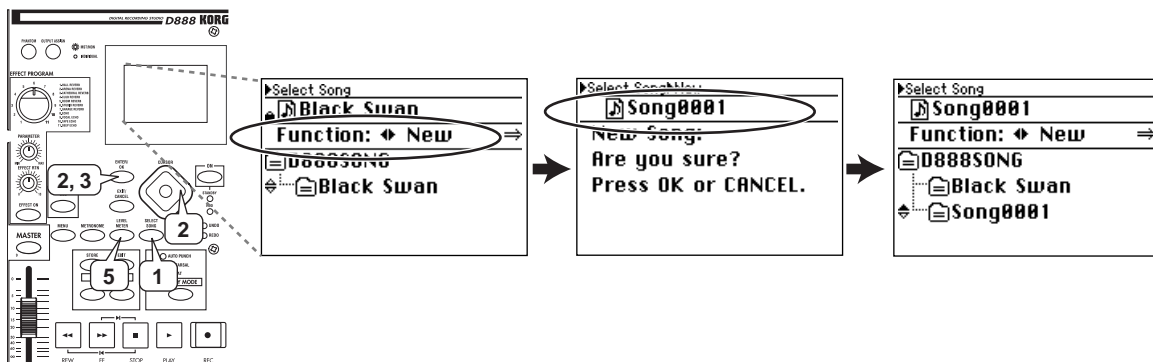

- 5) **Press the LEVEL METER button to return to the previous screen (Level Meter).**

3: Playback

4: Overdubbing

5: Mixdown and mastering

6: Structure

2-2. Connecting your input device

Next, we'll connect the L and R outputs of your keyboard to channels 1 and 2.

- 1) Connect output L of your keyboard to INPUT 1, and output R to INPUT 2.
- 2) Turn the TRIM knob to adjust the level so that the PEAK LEDs light when you play most strongly.

In the Level Meter screen, press the EXIT/CANCEL button several times to switch the level meters so that they show the inputs (IN), and check the input level.

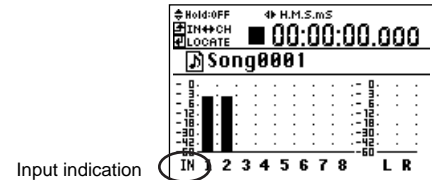
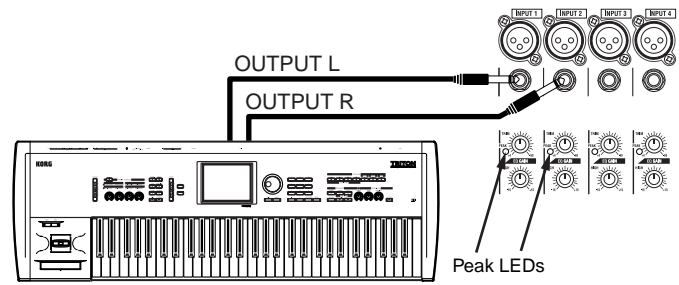

2-3. Start recording

- 1) Press the REC/PLAY button (it will light).
- 2) Press the channel buttons of tracks 1 and 2 several times to put these tracks in record mode (lit red).
- 3) Gradually raise the faders of tracks 1 and 2, and check the volume of your monitor speakers (or headphones).

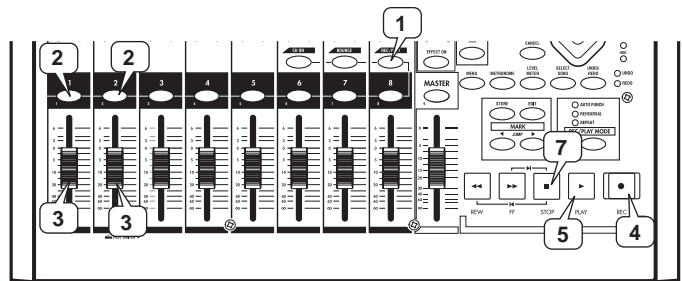

- 4) Press the REC button to enter record-ready mode (the button will light).
- 5) Press the PLAY button to start recording. (The REC and PLAY buttons will light.)
- 6) Begin performing.
- 7) When you're finished performing, press the STOP button to stop recording (the button will go dark).

⚠ The D888's recording level is set "pre-fader"; meaning the record levels are adjusted only by the TRIM knobs. The channel faders only adjust the audio level to the master and monitor outputs.

⚠ After recording, the screen will indicate "Working..." while the Undo data is being created. This process will require a correspondingly longer time for completion as the length of the song is longer.

3: Playback

3-1. Listening to the playback

- 1) Rewind back to where you started recording.
You can return to the beginning of the song by holding down the STOP button and pressing the REW button (→p.22 "2. Location").

- 2) Press the PLAY button to begin playback (the button will light).

note Since automatic switching between record/play is turned on (the factory setting), the tracks will automatically be in Play mode even if you don't change the track settings after recording (→p.31 "2-2. Auto input").

- 3) Press the STOP button to stop playback (the PLAY button will go dark).

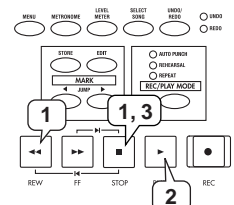

3-2. Adjusting the playback sound

- Turning the three **EQ GAIN knobs** of channels 1 and 2 will adjust the tone.
- Turning the **PAN knobs** of channels 1 and 2 will adjust the stereo position of each channel. In this example, channel 1 should be panned left, and channel 2 panned right to preserve the stereo imaging of your keyboard.

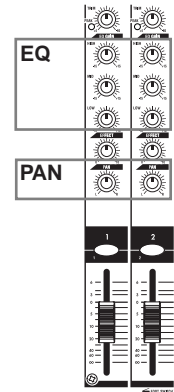

4: Overdubbing

Here's how you can record on track 3 using a microphone, while listening to the playback of the previously-recorded tracks 1 and 2.

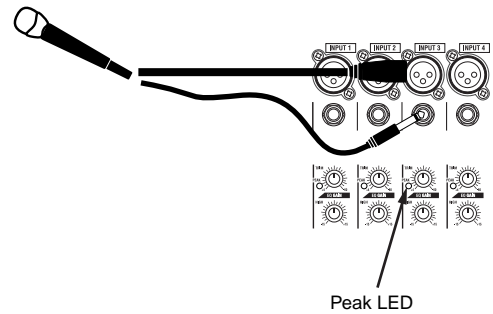

4-1. Connecting your input device

Begin by plugging in your mic.

- 1) Depending on the mic you're using, connect it to the **XLR jack or TRS phone jack of input 3**.

If you're using a condenser mic, turn on the **PHANTOM** button after you've connected the mic.

- 2) Turn the **TRIM knob** to adjust the level so that the **PEAK LED** lights when you speak or sing most strongly.

In the Level Meter screen, press the **EXIT/CANCEL** button several times to switch the level meters so that they show the inputs (IN), and check the input level.

4-2. Start recording

- 1) Press the **channel button of track 3** several times to put this track in record mode (lit red).
- 2) Gradually raise the faders of tracks 1, 2, and 3, and check the volume of your monitor speakers (or headphones).

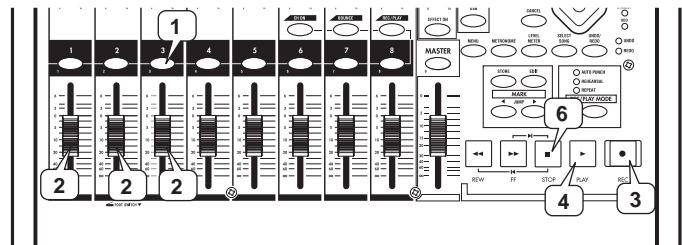

- 3) Press the **REC** button to enter record-ready mode (the button blinking).
- 4) Press the **PLAY** button to start recording. (The REC and PLAY buttons will light.)
- 5) While you listen to the playback of tracks 1 and 2, begin performing.
- 6) When you're finished performing, press the **STOP** button to stop recording (the REC and PLAY buttons will go dark).

⚠ After recording, the screen will indicate "**Working...**" while the Undo data is being created. This process will require a correspondingly longer time for completion as the length of the song is longer.

4-3. Listening to the song

Next we'll check whether your performance was recorded correctly.

- 1) Go back to the place in the song where you started recording. You can return to the beginning of the song by holding down the **STOP** button and pressing the **REW** button (→p.22 "2. Location").

- 2) Press the **PLAY** button to begin playback (the button will light).

note Since automatic switching between record/play is turned on (the factory setting), the tracks will automatically be in Play mode even if you don't change the track settings after recording (→p.31 "2-2. Auto input").

- 3) Press the **STOP** button to stop playback (the PLAY button will go dark).

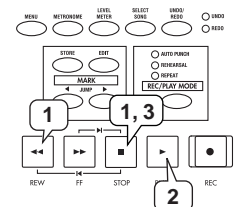

1: Setup and listening to the demo song

2: Recording

Basic operation

3: Playback

4: Overdubbing

5: Mixdown and mastering

6: Structure

5: Mixdown and mastering

“Mixdown” is the process of adjusting effects, EQ, and pan for the audio recorded on each track to create the overall balance you want, and recording this as stereo data. The D888 provides a master track for mixdown. Here’s how to mix down the song you recorded.

5-1. Adjusting the tone and volume of each track

- 1) If the channel buttons of tracks 1, 2, and 3 are not already in the play mode (lit green) press them several times until they are.
- 2) Press the **PLAY** button, and adjust each track while you listen to the playback.
 - Turn the three **EQ GAIN** knobs of channels 1, 2, and 3 to adjust the tone.
 - Turn the **PAN** knob of channels 1, 2, and 3 to left or right to adjust the stereo position.
 - If you want to apply an effect, press the **EFFECT ON** button (it will light) and turn the **EFFECT RTN** knob toward the right. Use the **EFFECT selector** to select an effect program.
 - Turn the **EFFECT knob** of channels 1, 2, and 3 toward the right to adjust the amount of effect for each channel (→p.33 “Effects”).

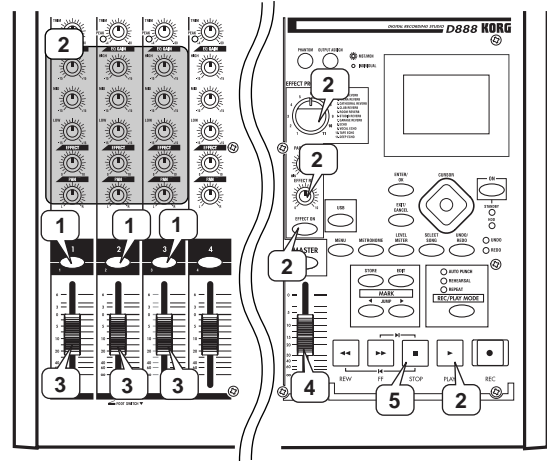

- 3) Use the **faders of channels 1, 2, and 3** to adjust the volume balance between the channels.
In the Level Meter screen, press the **EXIT/CANCEL** button several times to switch the level meters to the channel indication (IN) so that you can watch the input levels.
- 4) Use the **MASTER fader** to adjust the volume of the master track.
- 5) When you’re satisfied with the settings, press the **STOP** button to stop playback. (The button will go dark.)

5-2. Start recording

- 1) Press the **MASTER** button several times to choose **Record mode** (lit red).
- 2) Go back to the beginning of the song.
To move to the beginning of the song, hold down the **STOP** button and press the **REW** button.
- 3) Press the **REC** button to enter record-ready mode (button blinking).
- 4) Press the **PLAY** button to start recording. (The **REC** and **PLAY** buttons will be lit.)
- 5) When you’re finished recording, press the **STOP** button to stop recording.

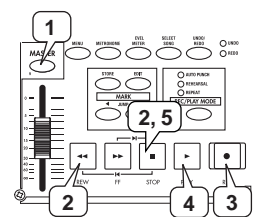

⚠ After recording, the screen will indicate “Working...” while the Undo data is being created. This process will require a correspondingly longer time for completion as the length of the song is longer.

5-3. Listen to your song

Next we’ll check whether the mixdown was recorded correctly.

- 1) Press the **MASTER** button several times to choose **Play mode** (lit green).
- 2) Move to the location at which you started recording.
You can return to the beginning of the song by holding down the **STOP** button and pressing the **REW** button.

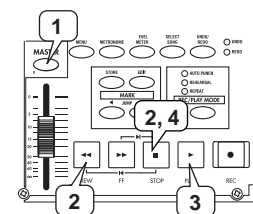

- 3) Press the **PLAY** button to begin playback (the button will light).
- 4) Press the **STOP** button to stop playback (the **PLAY** button will go dark).

5-4. Saving your song

On the D888, the song data that you have recorded or edited and the parameters that you have set are automatically saved during the power-off operation when you return the D888 to the standby mode. These settings are also saved when you select a different song. This is called “auto-save”. You can also save data manually (→p.36 “1-4. Saving a song”).

6: Structure

The following illustration is a simplified diagram showing the audio signal flow of the D888’s recorder and how the knobs and faders control the sound.

Use section “A” to adjust the recording level from each channel input to the channel tracks.

While recording, you can use section “B” to adjust the monitoring tone and volume.

You can also use section “B” to make adjustments when playing back the recorded performance.

Use section “C” to adjust the level that is recorded on the master track and sent from the output.

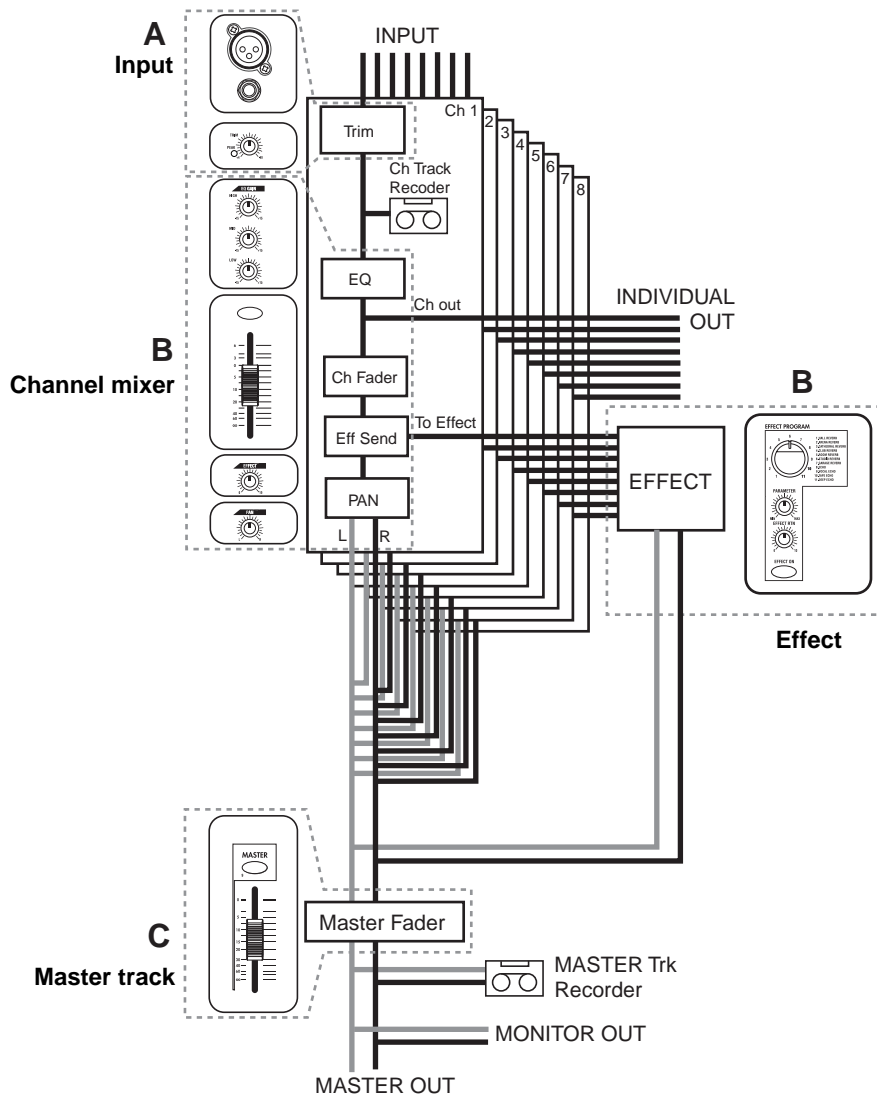

1: Setup and listening to the demo song

2: Recording

Basic operation

3: Playback

4: Overdubbing

5: Mixdown and mastering

6: Structure

Operation

Level Meter screen

When you turn on the power, the display will show this Level Meter screen. You can also access this screen by pressing the **LEVEL METER** button.

In this screen you can also view the D888's operating status and settings.

1. Display content and settings

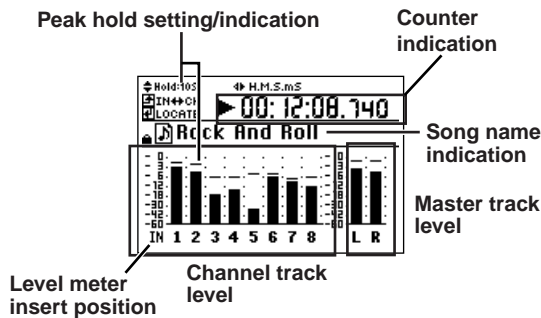

1-1. Peak Hold setting

When you're adjusting the audio input level or monitor level, lengthening the level meter's "Hold Time" can make it easier to view the levels.

- o If the display shows the Level Meter screen, press the cursor up/down buttons several times to set the "Hold Time".

The range is off (0), 4 seconds, 10 seconds, or forever (∞).

note Pressing the **LEVEL METER** button will clear the hold indication.

1-2. Level meter position

You can choose the position at which the channel track level meters are inserted in the signal path.

When recording on the channel tracks you'll want to see the input levels, and while recording on the master track or viewing the monitor levels you'll want to see the channel levels.

- o When the display shows the Level Meter screen, you can press the **EXIT/CANCEL** button repeatedly to cycle between input level and channel level metering. The display will indicate **IN** (input) or **CH** (channel).

note The master track level meter is always located after the master fader (master out).

1-3. Switching the counter display

You can choose the units that are shown in the location counter (see below) of the Level Meter screen.

- o When the display shows the Level Meter screen, you can press the left/right cursor buttons to switch the location units.

The location is shown by the counter in upper left of the screen, and you can switch between the following three types of units.

H.M.S.mS (time display)

... "Hours": "Minutes": "Seconds". "milliseconds"

The current location is shown as an absolute time from the beginning of the song.

* Maximum value is 5.59.59.999

H.M.S.F. (frame display)

... "Hours": "Minutes": "Seconds". "frames"

The current location is shown as an absolute time and number of frames from the beginning of the song. Normally you will use this when synchronized with MTC. The D888 uses the "30 non-drop" frame rate.

* Maximum value is 5.59.59.29F

Free Time (remaining time display)

... "Hours": "Minutes": "Seconds". "milliseconds"

The remaining time available for recording on the D888 (the remaining space of the hard disk) is shown.

1-4. Other Indicators

The Level Meter screen also shows other information to inform you of the D888's status and settings.

note You can press the **ENTER/OK** button to switch to the Location screen (\rightarrow p.22 "Using the counter to move").

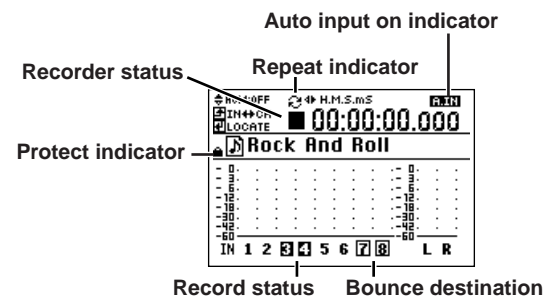

Auto Input On indication

This is shown if Auto Input is turned on. There is no indication if this is off (\rightarrow p.31).

Recorder status

A symbol in this area indicates the current status of the recorder, such as Recording, Playing, or Stopped (\rightarrow p.21).

Repeat indicator

This is shown if **REC/PLAY MODE** repeat is turned on. The panel **REPEAT** LED will be lit in this case (\rightarrow p.30, 32).

Protect indicator

A padlock symbol is shown here if the current song is protected. There is no indication if the song is not protected (\rightarrow p.36).

Record status

The track name below the level meter is highlighted for tracks that are set to Record.

Bounce destination

A square frame is shown around the track name below the level meter for tracks that are assigned as the bounce-destination (\rightarrow p.27).

Song and Location

1. Song

1-1. Creating a new song

This operation allocates space on the hard drive for recording. On the D888, this unit is called a “song”. You must create a new “song” before you can start a new recording. You can also refer to p.15 “2-1. Creating a new song”.

- 1) Press the **SELECT SONG** button to access the **Select Song** screen. The directory list appears, and the upper part of the page shows the song that you can currently play or record (this is called the “current song”).

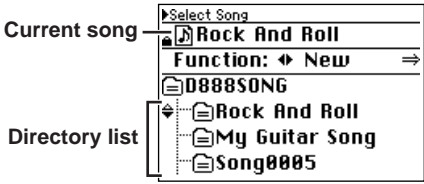

- 2) Use the left/right cursor buttons to select “NEW” in the **FUNCTION** area, and press the **ENTER/OK** button. The screen will ask “New Song: Are you sure?”
- 3) Press the **ENTER/OK** button once again to begin creating a new song. The screen will indicate “New Song: Working ...”
- 4) When the process is complete, a song named “Song*****” will be added. (***** is a consecutive number starting at 1.) “Song *****” will be selected as the current song.

1-2. Selecting an existing song

When loading a song, you can choose whether the mixer settings and effect settings of the song will also be loaded as well. (→p.48 “Song file details”).

- 1) Press the **SELECT SONG** button to access the **Select Song** screen. The song list appears in the directory area, and the upper part of the page shows the song that is currently selected for recording or playback (the “current song”).
- 2) Use the cursor left/right buttons to choose “Select” in the **FUNCTION** area, and use the cursor up/down buttons to select the desired song.
- 3) Press the **ENTER/OK** button. The selected song will be shown in the current song area, and the screen will indicate “Resume Mix/...”

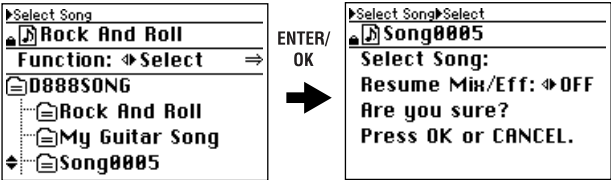

- 4) Use the cursor left/right buttons to select “ON” if you want the mixer and effect settings to also be loaded, or “OFF” if you don’t want these settings to be loaded. Then press the **ENTER/OK** button.
 - ⚠ You can’t choose “OFF” (i.e., “don’t load settings”) for a protected song.
 The screen will indicate “Select Song: Working...”
- 5) When the song has been loaded, the name of the selected song will appear in the current song area.

1-3. Renaming a song

You can rename the song that is currently selected. A song name of up to sixteen characters can be assigned.

- 1) Press the **SELECT SONG** button to access the **Select Song** screen. The song list appears as a directory display, and the upper part of the page shows the current song.
- 2) Use the cursor left/right buttons to select “Rename” in the **FUNCTION** area, and use the cursor up/down buttons to select the song that you want to rename. If you want to rename the current song, there’s no need to select a song.
- 3) Press the **ENTER/OK** button to access the **Rename** screen.

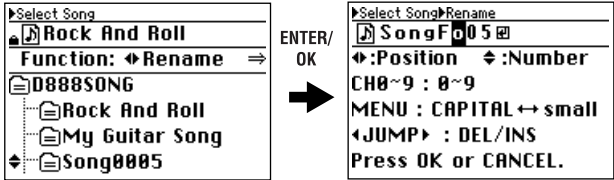

- 4) Use the cursor left/right buttons to select the position of the character you wish to change, and use the cursor up/down buttons to select the desired character. Alternatively, you can use the channel buttons to directly select numerals instead of using the cursor up/down buttons. Press the **MENU** button to switch between uppercase and lowercase characters. Use the **JUMP** buttons to delete (DEL) or insert (INS) characters.
- 5) To apply the changes you made, press the **ENTER/OK** button to confirm the edited name. If you decide to discard the changes you made, press the **EXIT/CANCEL** button.

You can use uppercase and lowercase alphabetical characters A-Z and a-z, numerals 0-9, space, and the symbols shown below.



1-4. Controlling a song

Use the transport buttons to perform song control operations such as recording and playback.

The current status of the song (e.g., playing or recording) is shown in the Level Meter screen.

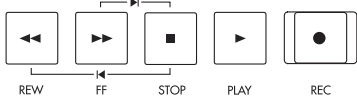

- PLAY button**
Starts playback. This button will be lit during playback, and blinking during fast-forward or rewind.
- REC button**
Starts recording. You can’t record unless at least one track is set to Record mode. When you press this button, the D888 will be in record-ready mode (button blinking); then press the **PLAY** button to start recording (button lit).
 - ⚠ The conditions for starting recording will depend on the **REC/PLAY MODE** setting.

- STOP button**
Stops recording or playback. You can hold down the **STOP** button and press the **REW** button to move to the beginning of the song, or hold down the **STOP** button and press the **FF** button to move to the end of the song.

Level Meter screen

Song and Location

Mixer

Recording (basic)

Recording (advanced)

Playback

Operation

Effects

Editing

Other

FF button

Fast-forwards the song.

The song will fast-forward as long as you continue holding down the **FF button**.

REW button

Rewinds the song.

The song will rewind as long as you continue holding down the **REW button**.

2. Location

On the D888, "location" means the position within the playback data of a song.

The counter in the Level Meter screen indicates the present location in the song, displayed in currently selected format (→p.20 "1-3. Switching the counter display").

This location shows you where you are in the song, and can be also used to edit or move song data.

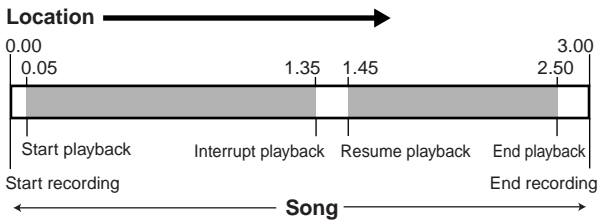

To change the location rapidly, you can register desired locations as "marks" and then select a desired mark to move instantly to the corresponding location.

2-1. Moving the location

Using the counter to move

When you're in the Level Meter screen, you can press the **ENTER/OK button** to switch to the Location screen.

Use the **cursor left/right buttons** to select the digit of the location that you want to change. Use the **cursor up/down buttons** to change the value. You can also use the **channel buttons** to directly specify a value, or use the **JUMP button** to change it.

When you've specified the location to which you want to move, press the **ENTER/OK button** to execute the move.

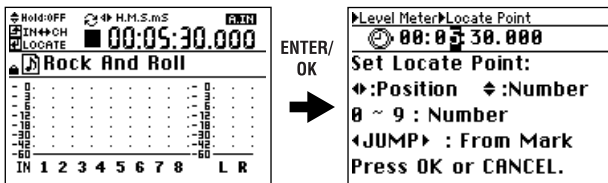

Using the FF and REW buttons to move

Moving to a point later in the song (fast-forward)

Press the **FF button**.

If you hold down the **FF button** during playback, you will move toward the end of the song. Playback will resume when you release the button.

If you hold down the **FF button** while stopped, you will move toward the end of the song and will stop when you release the button.

▲ If you press the **FF button** during repeat playback, repeat playback will stop, and then the location will begin moving toward the end of the song.

Moving to a point earlier in the song (rewind)

Press the **REW button**.

If you hold down the **REW button** during playback, you will move toward the beginning of the song. Playback will resume when you release the button.

If you hold down the **REW button** while stopped, you will move toward the beginning of the song and will stop when you release the button.

▲ If you press the **REW button** during repeat playback, repeat playback will stop, and then the location will begin moving toward the beginning of the song.

Moving to the beginning/end of the song

Moving to the beginning of the song

Hold down the **STOP button** and press the **REW button** to move to the beginning of the song.

Moving to the end of the song

Hold down the **STOP button** and press the **FF button** to move to the end of the song.

Using marks to move

You can assign marks to desired locations, and move instantly to the corresponding location.

You can store up to one hundred marks in each song.

These marks are listed in the Mark Edit screen, and you can use them as locate points for track editing or when performing auto-punch recording.

You can also use the **JUMP buttons** to move to a mark you've stored.

The mark list in the Mark Edit screen also shows the "Last Rec In" and "Last Rec Out" automatically to indicate the locations at which you most recently started and stopped recording.

▲ You can move to "Last Rec In" or "Last Rec Out" by selecting them in the list, but you can't delete these points or use the **JUMP buttons** to move to them.

Marks and location

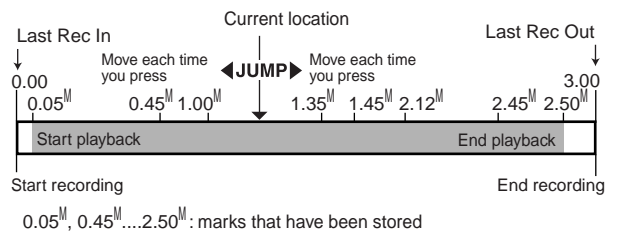

Content of the list in the Mark Edit screen

Location at which recording was last started (Last Rec In)		00:00:00.000
Location at which recording was last ended (Last Rec Out)		00:03:00.000
First mark from the beginning of the song		00:00:05.000
Second mark from the beginning of the song		00:00:45.000
Third mark from the beginning of the song		00:01:00.000
Last mark in the song		00:02:50.000

Storing a mark

- 1) **Move to the location that you want to store.**
Use the counter or the FF or REW buttons to move.
- 2) **Press the STORE button; a screen will ask you for confirmation.**
If you decide not to store the mark, press the EXIT/CANCEL button.

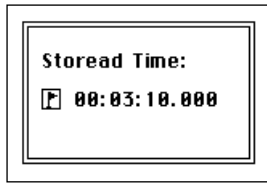

- 3) **Press the ENTER/OK button to store the mark. The mark will be stored immediately, and in several seconds you will return to the previous screen.**
To return to the previous screen immediately, you can press the ENTER/OK button while this screen is shown.

note Mark numbers are automatically reassigned according to their location, starting at the beginning of the song.

- 4) **Verify that the mark was stored.**
Press the MARK EDIT button, and look for the newly stored mark in the mark list of the Edit Mark screen. If you've stored more than three marks, use the cursor up/down buttons to scroll the list to find the mark you stored.

You can also store a mark while the song is playing or recording; simply perform steps 2) and following.

Selecting and moving to a mark

- 1) **Press the MARK EDIT button to access the Edit Mark screen.**
- 2) **Use the cursor left/right buttons to select "Recall," and use the cursor up/down buttons to select the desired mark in the mark list.**

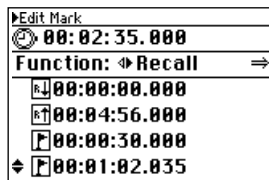

- 3) **Press the ENTER/OK button to move to the location of the mark.**

Moving sequentially through the stored marks

Press the JUMP ► button to change the location to the next mark, moving toward the end of the song.

Press the ◀ JUMP button to change the location to the preceding mark, moving toward the beginning of the song.

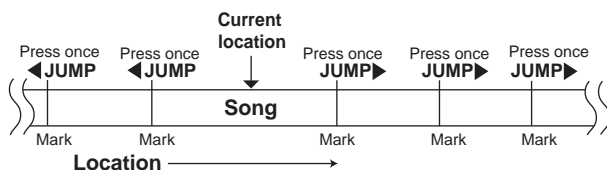

Deleting a mark

⚠ You can't use the Undo function after deleting a mark.

Deleting a single mark

- 1) **Press the MARK EDIT button to access the Edit Mark screen.**
- 2) **Use the cursor left/right buttons to select "Delete One," and use the cursor up/down buttons to choose the mark you want to delete.**
- 3) **Press the ENTER/OK button.**
The mark to be deleted will be selected, and the screen will ask "Delete Mark: Are you sure?"

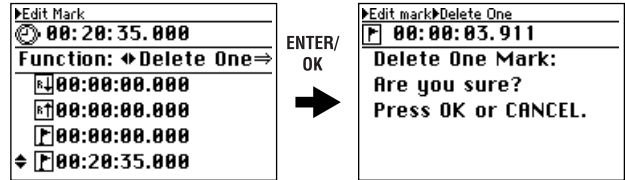

- 4) **Press the ENTER/OK button once again.**
When deletion is complete, the screen will indicate "Delete One Mark: Completed".
- 5) **When you press the ENTER/OK button, you will move to the mark that preceded the deleted mark, and return to the Edit Mark screen.**

Deleting all marks

- 1) **Press the MARK EDIT button to access the Edit Mark screen.**
- 2) **Use the cursor left/right buttons to select "Delete All".**
- 3) **Press the ENTER/OK button.**
The screen will ask "Delete All Marks: Are you sure?"
- 4) **To execute the Delete operation, use the cursor left/right buttons to select "Yes" for the "Execute" field, and then press the ENTER/OK button once again.**
When deletion is complete, the screen will indicate "Delete All Marks: Completed".

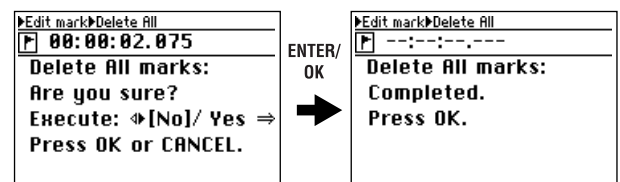

- 5) **When you press the ENTER/OK button, all marks will be deleted and you will return to the Edit Mark screen.**

⚠ You can't delete "Last Rec In" and "Last Rec Out".

Mixer

1. Mixer inputs

The D888 has eight sets of analog input jacks. The audio from the devices connected to these input jacks 1 through 8 are assigned to mixer channels 1 through 8, and can be recorded on the corresponding tracks.

1-1. Connecting audio sources

Keyboard or line output device

Connect keyboards and other line level signals to the TRS phone jacks. In this case, the TRS phone jacks will take priority even if a mic is connected to the corresponding XLR jacks.

Guitar or bass

Connect your guitar or bass to the TRS phone jacks. The D888 does not have a dedicated guitar jack, so you may use any channel.

note A guitar or bass that has active pickups can be connected directly to the D888's inputs. However if your instrument has passive pickups (i.e., without a built-in preamp), the impedance mismatch will mean that you will not obtain a satisfactory input volume or audio quality. In such cases, please route your instrument through a preamp or effect unit.

Mic

Connect your mics to either the TRS phone jack or the XLR jack, depending on the type of mic you're using. If you use the XLR jack, don't use the TRS phone jack of the same channel, since the XLR jack is unavailable if the TRS phone jack is connected.

⚠ If you use phantom power, please be aware that it is supplied to all eight channels.

⚠ You may damage your mic or the D888 if you connect or disconnect a mic while phantom power is turned on.

1-2. Adjusting the input level

On the D888, the input channels correspond to the channel tracks. There are no routing settings to worry about; the audio signals received at **INPUT jacks** 1, 2 ... 8 are sent to channel tracks 1, 2 ... 8 respectively.

- 1) **Connect your input device.**
Lower the **MASTER fader**, **PHONES level knob**, and **monitor LEVEL knobs** before you connect your device to the **INPUT jacks**.
- 2) **Send the input signal to the mixer channel.**
 - Turn the **CH ON button** on, and set the **channel button** of each channel to on (lit orange).
 - Turn the **REC/PLAY button** on, and set the **channel button** of the channel to Record (lit red).
- 3) **Adjust the input level.**
Adjust the **TRIM knob** so that the **PEAK LED** does not light when the input device is played at its maximum volume.
When doing so, you can switch the display to the Level Meter screen and press the **EXIT/CANCEL button** to switch to the input display (IN) so that you can watch the input level.

1-3. Adjusting the monitor level

- 1) Switch the display to the Level Meter screen, and press the **EXIT/CANCEL button** several times to choose the channel display (CH).
- 2) Set the channel fader to unity gain (0 dB).
- 3) When there is input from your input device, the level meter in the screen will move according to the input.
- 4) Adjust the channel fader so that the clip indicator "□" does not appear in the level meter even when you play most strongly.
 - Gradually raise the **MASTER fader** and **PHONES level knob** or **monitor LEVEL knob** until you can hear the sound in your headphones or from the monitor speakers connected to the **MONITOR jacks**.

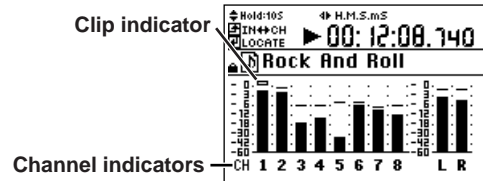

2. Mixer outputs

The eight outputs of the D888 can be reconfigured using the **OUTPUT ASSIGN button**.

Pressing this button will toggle between the **MST/MON** (button lit) and **INDIVIDUAL** (button dark) output configurations.

2-1. When MST/MON is selected

The output jacks will carry the audio signals of **MASTER L,R**, **MONITOR L,R**, and mixer channels 5, 6, 7, and 8.

MASTER L,R

These jacks output the audio of the master bus. Use the **MASTER fader** to adjust the level.

MONITOR L,R

These jacks output the audio of the master bus after the **MASTER fader**. Use the **monitor LEVEL knob** to adjust the final level.

5, 6, 7, 8

These jacks output the audio of channel tracks 5, 6, 7, and 8 from a point immediately before the **channel faders**. You can use these as **AUX OUT jacks**.

S/P DIF OUT

This jack outputs the same audio signal as the **MASTER L,R jacks** as a 44.1 kHz 16-bit digital signal.

PHONES 1, 2

These jacks output the same audio signal as the **MONITOR L,R jacks**. Use the corresponding **PHONES level knob** to adjust the level.

2-2. When INDIVIDUAL is selected

Each jack will carry the audio output of a single mixer channel of the same number - 1, 2, 3, 4, 5, 6, 7, and 8.

1, 2, 3, 4, 5, 6, 7, 8

These jacks output the audio of channel tracks 1, 2, 3, 4, 5, 6, 7, and 8 from a point immediately before the channel faders. You can use these as pre-outputs for the devices connected to the D888.

The output of channel tracks 1 and 2 can be adjusted by the monitor LEVEL knob.

Note If you want the output level of channel tracks 1 and 2 to match the output of channel tracks 3 through 8, turn the monitor LEVEL knob to "10" (all the way toward the right).

S/P DIF OUT

This jack outputs the same audio signal as channel tracks 3 and 4 in the form of a 44.1 kHz 16-bit digital signal.

PHONES 1, 2

These jacks output the same audio signal as channel tracks 1 and 2. Use the corresponding PHONES level knob to adjust the level.

3. Adjusting the mixer

Use the mixer section to monitor the inputs, and to create a listening mix by adjusting the volume, tone, and pan of the playback.

Note For details on adjusting effects, refer to p.33 "Effects".

3-1. Adjusting the volume

Adjusting the volume level of each channel

Use the channel faders to adjust the monitoring level of the inputs or playback. Raise or lower the fader to adjust the volume.

- 1) Switch the display to the Level Meter screen, and press the EXIT/CANCEL button several times to select the channel level display.
- 2) Use the channel faders to adjust the volume while you watch the level meters, making sure to avoid clipping the signal.

Note The channel faders let you adjust the gain in a range of silence ($-\infty$) - unity gain (0 dB) - +6 dB.

Adjusting the overall volume level

Use the MASTER fader to adjust the volume that is output from the MASTER OUT jacks, the volume that is sent to the MONITOR OUT jacks and the headphone jacks, and the level that is recorded on the master track.

- 1) Switch the display to the Level Meter screen, and press the EXIT/CANCEL button several times to select the channel level display.
- 2) Use the MASTER fader to adjust the volume being recorded on the master track while you watch the level meters, making sure to avoid clipping the signal.

Use the monitor LEVEL knob to adjust the final volume that is output from the MONITOR OUT jacks.

Use the PHONES level knobs to adjust the final volume that is output from the headphone jacks.

3-2. Adjusting the pan

Use the PAN knob of each channel to adjust the pan (stereo position).

3-3. EQ (Equalizer)

HIGH, MID, and LOW equalizer gain knobs are provided on each channel to adjust the high, mid, and low-range gain. You can boost or cut the gain of each band by +/-15 dB. The center frequencies are fixed at 10 kHz, 2.5 kHz, and 100 Hz. The EQ applies to the playback, and to the master and channel output, but is not applied when recording individual tracks (Refer to p.19 "6: Structure").

Applying EQ to the playback

- 1) Press the REC/PLAY button, and press the channel button of the channel whose EQ you want to adjust (the button will light green).
- 2) Press the PLAY button to play back the song.
- 3) Use the HIGH, MID, and LOW knobs to adjust the high, mid, and low-range gain.
- 4) Press the LEVEL METER button, and use the level meters to check the channel levels.

If you boost or cut the EQ values by a large amount, you may need to re-adjust the level balance between channels or the overall level (Refer to "3-1. Adjusting the volume").

3-4. Muting a channel

You can turn the CH ON button on, and then use the channel buttons to mute (silence) individual channels.

- 1) Turn the CH ON button on. Channel buttons of enabled channels will light orange.
Note If you've created a new song, all channels will be enabled.
- 2) Press the channel button of the channel you want to mute; the sound will be muted and the button will go dark.

4. Metronome

You can listen to a metronome while you record.

You can send the metronome from the master outputs and the monitor outputs, but you can also choose to send the metronome only from the monitor output if you don't want it to be heard from the master outputs (for example during a live performance).

- 1) Press the METRONOME button to access the Metronome screen.
- 2) When you press the ENTER/OK button, a check mark will appear for the "Use Metronome" setting, and the metronome will be turned on. The metronome will switch between on and off each time you press the ENTER/OK button.
- 3) Use the cursor up/down buttons to select the parameter you want to adjust, and the cursor left/right buttons to select the value or setting.

If "Use Metronome" is on, the METRONOME button will light and the metronome will start when you begin recording.

Metronome	
<input checked="" type="checkbox"/> Use Metronome	
Tempo =	128
Beat =	4
Volume =	8
Assign =	MST&MON

Metronome parameters

Tempo	♩ = 40-240
Beat (time signature)	0 (no strong beat), 2, 3, 4, 6, 8 beats
Volume	0-10
Assign (output destination)	Mst&Mon (Master & Monitor), Monitor

Level Meter screen

Song and Location

Mixer

Recording (basic)

Recording (advanced)

Playback

Operation

Effects

Editing

Other

Recording (basic)

During regular recording, the D888 can record up to eight individual tracks. During mixdown, the D888 can record a single stereo master track.

1. Virtual tracks

The D888 has eight channel tracks for each song, and each channel track has eight virtual tracks.

When recording or playing, you can specify the virtual track that will be used for recording or playback.

This means that by switching between virtual tracks, you can record multiple performances and choose the best take afterward.

Since you can perform bounce-recording even after you've recorded all eight channels, you can also re-record onto the tracks you've freed-up by bouncing.

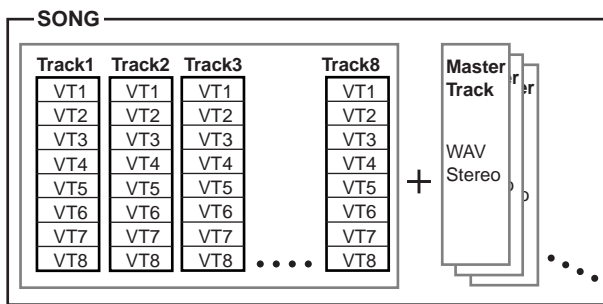

1-1. Selecting virtual tracks

- 1) Press the MENU button to access the Menu screen.
- 2) Use the cursor up/down buttons to choose "1. TRACK," and use the cursor left/right buttons to select "V.Track". Alternatively, you can press channel button "1" to select "1. TRACK" instead of using the cursor up/down buttons.
- 3) Press the ENTER/OK button to access the Virtual/Wav screen.

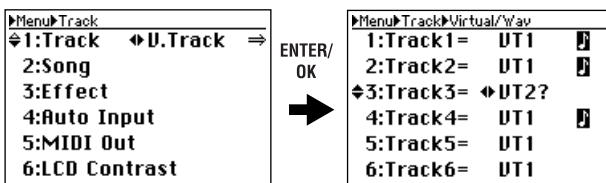

- 4) Use the cursor up/down buttons to select the track whose virtual track you want to change, and use the cursor left/right buttons to select a virtual track. Alternatively, you can press a channel button 1-8 to select a virtual track instead of using the cursor up/down buttons.
- 5) When you change the virtual track, an "?" indication will appear. Press the ENTER/OK button to confirm the change. If you use the cursor up/down buttons (or a channel button) to move to another track when the "?" indication is still shown, the change in virtual track will be discarded.
- 6) When you've confirmed all of your changes and there are no "?" indications shown in the Virtual/Wav screen, press the EXIT/CANCEL button to return to the Menu screen.

1-2. Track display

The virtual track you've selected for recording and playback is shown as an indication of VT1-VT8 in the Virtual/Wav screen.

You can also select WAV files in the virtual track selection screen, but if you select a WAV file (→p.39), you won't be able to record on the track that is adjacent to this track. If you want to record, be sure to select VT1-VT8.

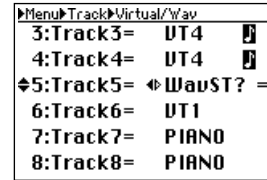

VT1...VT8: These are virtual tracks that can be recorded by the D888. An icon is shown for virtual tracks that have already been recorded.

WavST?: This is shown when you first select a WAV file instead of using a virtual track (→p.39).

Other: If a WAV file is selected, approximately the first eight characters of the file name are shown.

2. Types of recording

There are several types of recording, such as channel track recording, overdub recording, bounce recording, and master track recording. By using these various methods appropriately, you can combine large numbers of recorded tracks into a stereo master track.

Channel track recording

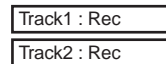

Overdub recording

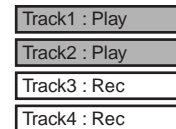

Bounce recording (bouncing to channel tracks)

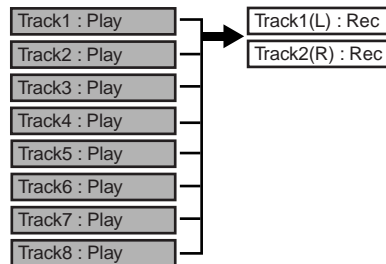

Master track recording (bouncing to the master track)

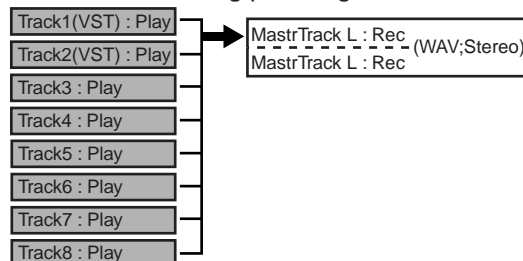

note It's convenient to turn the Auto Input setting on (the default setting) so that tracks assigned for recording will automatically play back when the recorder is in Play mode (→p.31).

In addition to the types of recording described above, you can also use punch recording to re-record a specified region of an existing performance, loop recording, and also a track copy function that is not actually a recording operation but allows you to copy tracks in the same way as bounce recording. (Refer to "Recording (advanced)")

▲ After recording, the screen will indicate “Working...” while the Undo data is being created. This process will require a correspondingly longer time for completion as the length of the song is longer.

Procedure for completing a song

To create a song, you will start by recording the tracks for each of the channels. You can record up to eight channels simultaneously, or you can record them one by one (overdubbing).

If you use up all eight tracks, you can perform bounce recording to free up some tracks and then record additional material on those tracks.

▲ If you want to keep the original recordings that you bounced, you can switch the virtual track for those channels and record on them again without overwriting the original recordings.

By repeatedly bounce-recording and overdubbing on up to eight tracks in this way, you will finish recording your channel tracks.

Then you will create the final mixdown by recording it on the master track in stereo.

The master track is recorded as a stereo 16-bit 44.1 kHz WAV file. This means that you can connect your computer and write that file to digital media to create an audio CD or the equivalent.

A new master track WAV file for this song is created every time you mix down (i.e., every time you record the master track), so you can create different mixes and choose the best one later.

▲ A master track WAV file is created in the song folder each time you record, up to the available capacity of the hard disk drive. However, the D888 is able to recognize only one hundred such files.

▲ The most recently recorded WAV file will be selected for the master track. If you want to hear a master track WAV file that you recorded earlier, select the desired file as described in p.39 “2-4. Selecting a master track file (Master)”.

2-1. Recording channel tracks

Here’s how to record channel tracks. You can record up to eight channels simultaneously.

- 1) **Create a new song** (→p.21 “1-1. Creating a new song”).
- 2) **Connect an audio source to the channel on which you want to record it** (→p.24 “1-1. Connecting audio sources”).
- 3) **Put the channel to be recorded in Record mode.**
 - Turn the **REC/PLAY button** on, and set the appropriate **channel button** to Record mode (lit red).
- 4) **Adjust the input level.**

Adjust the **TRIM knob** so that the **PEAK LED** does not light when the audio input source is at its maximum volume.

When making this adjustment, you can switch the display to the Level Meter screen and press the **EXIT/CANCEL button** to select the input display (IN) so that you can view the levels.
- 5) **Adjust the monitor level** (→p.24 “1-3. Adjusting the monitor level”).
- 6) **Move the current location to the point at which you want to start recording.**

You can move to the beginning of the song by holding down the **STOP button** and pressing the **REW button**.
- 7) **Put the recorder in record-ready mode.**

Press the **REC button** (it will blink).
- 8) **Begin recording.**

Press the **PLAY button**. (The REC and PLAY buttons will light.)
Begin performing.

9) Stop recording.

When you’ve finished performing, press the **STOP button**. (The **REC** and **PLAY buttons** will go dark.) Return to the location at which you began recording, and verify that the performance was recorded correctly.

note You can return to the location at which recording began by selecting **Last Rec In** in the mark list of the Mark Edit screen.

2-2. Overdub recording

Here’s how to record additional performances on other tracks while you listen to the previously-recorded performances.

- 1) **Connect an audio source to the channel on which you want to record it** (→p.24 “1-1. Connecting audio sources”).
- 2) **Select the tracks for playback.**

Press the **REC/PLAY button**, and press the channel buttons to select Play mode (button lit green) for each track that you want to hear.
- 3) **Select a track for recording.**

Press the appropriate channel button to select Record mode (button lit red).
- 4) **Record.**

Refer to steps 4) through 9) in the preceding section “2-2. Recording channel tracks”.

2-3. Bounce recording

The D888 can record a maximum of eight channels simultaneously, but you can use “bounce recording” to combine these eight channels into two channels or one channel.

While you listen to the playback of the bounced tracks, you can continue overdubbing to build up a complex arrangement as though you were using a 16-track or 32-track recorder.

To free up extra tracks for recording, you can bounce multiple tracks down to two tracks (stereo) or to one track (mono).

note You can also use an effect while bounce-recording (→p.33).

▲ When bouncing to one track, you can choose any track. However when bouncing to two tracks, you can only select a pair of adjacent tracks (1-2, 3-4, 5-6, or 7-8).

Combining multiple tracks into two tracks (stereo)

If the bounce-destination already contains recorded data, it will be overwritten and replaced by the newly recorded data; i.e., you will lose the previously recorded data. If you want to preserve the data on the tracks/virtual tracks you will be bouncing to, you can copy the data to a different set of virtual tracks before you begin bounce recording. Alternatively, you could copy the track data to a computer via USB as a safety back up.

- 1) **Make sure that you’ve selected the desired virtual track for each playback track you want to bounce.**

note If there are any tracks you don’t want to include, in the bounce recording, lower their faders or press the **CH ON button** and then press the corresponding **channel buttons** to mute (silence) those tracks.

- 2) **Press the BOUNCE button, and then press the two channel buttons for an adjacent pair of tracks to specify the bounce-destination.**

The **channel buttons** you selected as the bounce-destination will blink red.

note The bounce-destination can be a stereo set of tracks (1-2, 3-4, 5-6, or 7-8), and the two tracks will contain the L and R channels respectively.

▲ You cannot select any combination of tracks other than 1-2, 3-4, 5-6, or 7-8. If you press any other combination of channel buttons, the valid combination of channels for the button you last pressed will be enabled.

▲ If the bounce-destination already contains recorded data, it will be overwritten and replaced by the newly recorded data; i.e., you will lose the previously recorded data.

- 3) **Adjust the EQ and pan of each playback track.**
Press the **PLAY** button to play back. Use the track 1–8 **EQ GAIN** knobs to adjust the tone, and the **PAN** knobs to adjust the stereo position.
- 4) **Adjust the playback and recording levels.**
Use the **channel faders** to adjust the playback levels. You can press the **LEVEL METER** button and watch the channel level (CH) corresponding to each fader.
- 5) **Use the MASTER fader to adjust the recording level.**
When you've finished making adjustments, press the **STOP** button.
- 6) **Move the current location to the point at which you want to start recording.**
You can move to the beginning of the song by holding down the **STOP** button and pressing the **REW** button.
- 7) **Put the recorder in record-ready mode.**
Press the **REC** button (it will blink).
- 8) **Begin recording.**
Press the **PLAY** button. (The **REC** and **PLAY** buttons will light.)
Playback will begin.
- 9) **Stop recording.**
When playback ends, press the **STOP** button. (The **REC** and **PLAY** buttons will go dark.) Return to the location at which you began recording, and play back to verify that recording occurred correctly.

Combining multiple tracks into one track (monaural)

- 1) **Make sure that you've selected the desired virtual track for each playback track you want to bounce.**
note If there are any tracks you don't want to include, lower their faders or press the **CH ON** button and then press the corresponding **channel buttons** to mute (silence) those tracks.
- 2) **Press the BOUNCE button, and then press a channel button to specify the bounce-destination.**
The channel button you selected as the bounce-destination will blink red.
note As the bounce-destination, you should select an unrecorded channel track or an unrecorded virtual track of a track that's not playing back. If you select an already-recorded track or a virtual track of that track, the existing data will be overwritten, so the data originally recorded in that channel track will be lost.
- 3) **Adjust the EQ of each playback track.**
Press the **PLAY** button to play back. Use the track 1–8 **EQ GAIN** knobs to adjust the tone.
- 4) **Perform steps 4) through 9) of the preceding section "Combining multiple tracks into two tracks (stereo)".**

2-4. Recording the master track

When you're finished recording, you can apply EQ and an effect to the playback to adjust the final overall balance, and then create a master track.

Each master track you create is preserved as a stereo WAV file. The files will automatically be named MST0001.WAV, MST0002.WAV, MST0003.WAV, and so on, in order of their creation.

note The WAV file that was most recently recorded in this way will always be selected for the master track, so if you want to hear the WAV file of a master track you recorded earlier, you'll need to use the operation described on p.39 "Selecting a master track file".

▲ A master track WAV file you create in this way can be selected for a channel track and played back (→p.39).

- 1) **Make sure that you've selected the desired virtual track for each playback track 1–8 you want to record to the master track.**
- 2) **Select the desired playback tracks.**
Press the **CH ON** button, and press the channel button for each track you don't want to play, making the channel button go dark.
- 3) **Press the MASTER button several times to make it light red.**
The **channel buttons** of the playback tracks will be green.
- 4) **Perform steps 4) and following of "2-3. Bounce recording".**

You can also use the effect while you record the master track (→p.33).

Recording (advanced)

1. Re-recording

1-1. Punch-in Recording

(Re-recording a specific area)

If you made a mistake in a recorded performance, or are not satisfied with a portion of the performance, you can use “punch-in/out” recording to fix just that portion without having to record the entire part over again. Punch-in/out recording can be done manually or automatically.

Punch-in: Switches from the playback mode to the record mode.

Punch-out: Switches from the record mode back to the playback mode.

⚠ After recording, the screen will indicate “Working...” while the Undo data is being created. This process will require a correspondingly longer time for completion as the length of the song is longer.

Manual punch-in/out

Here’s how to punch-in and punch-out manually. During playback, press the **REC button** or a foot switch (we recommend the separately sold Korg PS-1 pedal switch) to begin recording, and then press the **REC button, PLAY button**, or foot switch to stop recording.

⚠ You can’t punch-in again after punching-out.

Manual punch-in/out recording

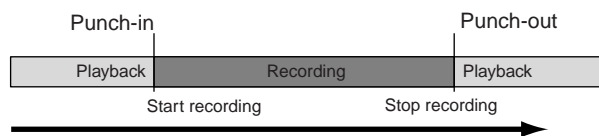

- 1) **Connect your audio source device to the channel that you want to partially re-record** (→p.24 “1-1. Connecting audio sources”).
- 2) **Select the tracks that you want to play back.** Press the **REC/PLAY button**, and press the **channel buttons** of the desired tracks to put them in Play mode (button lit green).

note If there is a track that you don’t want to play, press the **CH ON button** and then press the **channel button** for that track to mute it (the button will go dark).
- 3) **Arm the track that you want to re-record.** Press the channel button of the track you want to re-record, putting it in Record mode (button blinking red).
- 4) **Adjust the input level.** Adjust the **TRIM knob** so that the **PEAK LED** does not light even when the audio source device is played at its loudest level. At this time, you may find it convenient to select the Level Meter screen and press the **EXIT/CANCEL button** to select the input display (IN) so that you can view the levels.
- 5) **Adjust the monitor level** (→p.24 “1-3. Adjusting the monitor level”).
- 6) **Move the location to a point slightly earlier than where you want to begin re-recording** (→p.22).
- 7) **Press the PLAY button to begin playback.** (The **PLAY button** will light.) The song will play back, and you will hear the playback tracks as well as the track you’re going to partially re-record.

- 8) **Press the REC button at the location at which you want to start re-recording.** (The **REC** and **PLAY** buttons will light.) Recording will begin (manual punch-in), allowing you to re-record your performance.
- 9) **Press the REC button or PLAY button at the location at which you want to stop re-recording.** (The **REC** button will go dark.) Recording will end, and playback will resume (manual punch-out).
- 10) **Press the STOP button to stop playback.** (The **PLAY button** will go dark.) After you’ve finished recording, move the current location to a point slightly earlier than where you began recording, and play back to verify the recorded content.

Using a foot switch for manual punch-in/out

You can alternately punch-in or punch-out by pressing a foot switch (we recommend the Korg PS-1 pedal switch). This is convenient when your hands are occupied with playing your instrument, or if you need to punch-in/out from a distance.

- 1) **Connect your foot switch to the FOOT SWITCH jack.**
- 2) **Set the polarity of the foot switch** (→p.40).
- 3) **Perform manual punch-in/out.** Proceed as described in “Manual punch-in/out”. In steps 8) and 9), you can press the foot switch to punch-in and punch-out.

Auto punch-in/out

Auto punch-in/out recording is a function that automatically starts recording (punch-in) and stops recording (punch-out) at the locations that you specify beforehand.

Auto punch-in/out recording

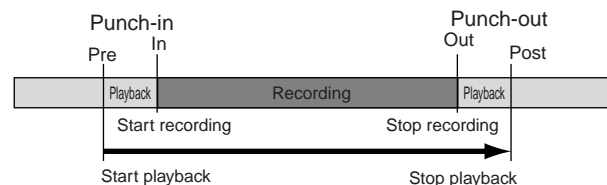

- 1) **Perform steps 1) through 5) of “Manual punch-in/out,” above.**
- 2) **Press the REC/PLAY MODE button to access the Rec/Play Mode screen, use the cursor up/down buttons to select “Auto-Punch,” and press the ENTER/OK button.** A check mark will be added to the Auto-Punch field, and the **AUTO PUNCH LED** will light.

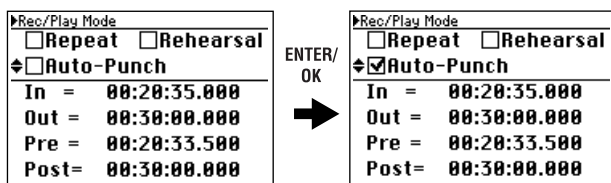

- 3) **Use the cursor up/down buttons to select “In= ...” (punch-in) or “Out=...” (punch-out), and press the ENTER/OK button.** The display will show the point setting screen.
- 4) **Use the point setting screen to specify the locate points.** Refer to “Setting the In, Out, Pre, and Post locate points”.

Level Meter screen

Song and Location

Mixer

Recording (basic)

Recording (advanced)

Playback

Operation

Effects

Editing

Other

- Specify how playback will occur before and after the recording.
Use the cursor up/down buttons to select "Pre=..." (the location at which playback will start, before the beginning of recording) or "Post=..." (the location at which playback will end, after the end of recording), and press the ENTER/OK button.

The point setting screen will appear in the display.

- Use the point setting screen to specify the locate points.
Refer to "Setting the In, Out, Pre, and Post locate points".
- Press the LEVEL METER button to return to the Level Meter screen.
- Begin recording.
 - When you press the REC button, you will move to the locate point specified by "Pre=..." and enter record-ready mode (REC button blinking).
 - When you press the PLAY button, playback will begin. Recording will occur from the locate point specified for "In=..." (The REC and PLAY buttons will light.)
- Stop recording.
 - Recording will stop when you reach the locate point specified for "Out=..." and playback will resume. (The REC button will go dark and the PLAY button will light.)
 - Playback will stop when you reach the locate point specified for "Post=..."

Setting the In, Out, Pre, and Post locate points

To set the locate points, you can enter them numerically in the point setting screen, or you can store them beforehand as marks (→p.22).

note After selecting a mark, you can also make fine adjustments to its value if desired.

! If the locate point you specify does not meet the following condition, an error indication will appear, and the setting will not be accepted.

$$Pre \leq In < Out \leq Post$$

Using numeric input

- Use the cursor up/down buttons to select "In=..." (or "Out=...", "Pre=...", "Post=..."), and press the ENTER/OK button to access the point setting screen.

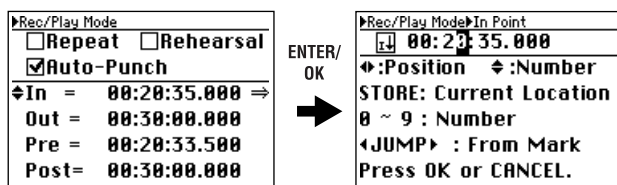

- Use the cursor left/right buttons to select the desired position, and use the cursor up/down buttons to select a numeric value.
You can also use the channel buttons to enter numeric values directly, instead of using the cursor up/down buttons.
By pressing the STORE button at this time, you can specify the current location as the point.
- When you're finished entering the point, press the ENTER/OK button to confirm your entry.

Using marks

- Use the cursor up/down buttons to select "In=..." (or "Out=...", "Pre=...", "Post=..."), and press the ENTER/OK button to access the point setting screen.

- Use the JUMP buttons to select the stored mark that corresponds to the desired locate point.
You can use step 2) of "Using numeric input" to adjust the value if desired.
- Press the ENTER/OK button to confirm your entry.

1-2. Repeat recording

If "Repeat" is turned on in the Rec/Play Mode screen when you make auto punch-in/out settings, the IN-OUT region will be recorded repeatedly.

- Make auto punch-in/out settings.
Refer to steps 1) through 6) of the preceding section "Auto punch-in/out".
- Use the cursor up/down buttons to select "Repeat" and press the ENTER/OK button.
A check mark will be added (the setting will be on), and the REPEAT LED will light.
- Specify the locate points for auto punch-in/out.
Refer to steps 7) through 11) of the preceding section "Auto punch-in/out".

Auto punch-in/out, repeat recording

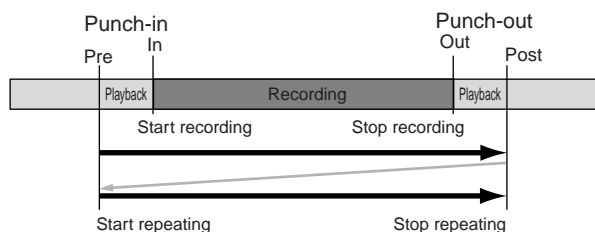

- Start recording.
 - When you press the REC button, you will move to the locate point specified by "Pre=..." and enter record-ready mode. (The REC button will blink.)
 - When you press the PLAY button, playback will begin. Recording will occur from the locate point specified by "In=..." (The REC and PLAY buttons will light.)
 - When you reach the locate point specified by "Out=..." recording will end and playback will resume. (The REC button will be dark and the PLAY button will light.)
 - When you reach the locate point specified by "Post=..." playback will stop.
 - Then you will move to the locate point specified by "Pre=..." and the same operations will continue repeating.
 - When you are satisfied with the performance you re-recorded, press the STOP button outside the recorded region (IN-OUT) to stop repeating.

note You can use the Undo/Redo function to compare and choose between the most recent recording and the recording that precedes it.

- Listen to the recorded performance.
 - Press the PLAY button to play back, and listen to the recorded performance. If "Repeat" is on, playback will occur from the IN (punch-in) location to the OUT (punch-out) location.

2. Recording-related functions

2-1. Rehearsal function

The D888 provides a rehearsal function that lets you practice with the mixer settings, LEDs, and display in the same state as when actually recording.

This operation does not actually record anything, and will not occupy space on the hard disk.

You can practice as many times as you like under the same conditions as when actually recording, until you're satisfied with your playing.

When you're ready, simply turn off the rehearsal function to record immediately with the same settings.

note If you want to re-do a specific portion of a recording, it is convenient to use the rehearsal function in conjunction with the "repeat recording" function described in the preceding section.

Turning the rehearsal function on

- 1) Press the REC/PLAY mode button to access the Rec/Play Mode screen, and use the cursor up/down buttons and the cursor left/right buttons to select "Rehearsal".
- 2) Press the ENTER/OK button.
A check mark will be added to the setting (it will be turned on), and the REHEARSAL LED will light.

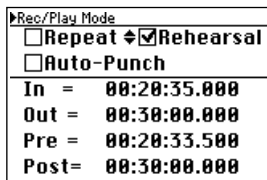

- 3) Proceed as described in "2-2. Channel track recording" or "2-3. Overdub recording".

As long as the REHEARSAL LED is lit, no new recording will occur regardless of how many times you repeat this.

Turning the rehearsal function off

- 1) Press the REC/PLAY mode button to access the Rec/Play Mode screen, and use the cursor up/down buttons and the cursor left/right buttons to select "Rehearsal".
- 2) Press the ENTER/OK button.
The check mark will be cleared (the setting will be turned off), and the REHEARSAL LED will go dark.
- 3) Record with the current settings.

2-2. Auto input

Automatically switching between recording and playback

This function automatically switches the mixer channel inputs in tandem with the record/playback state of the recorder.

Normally you will leave this on so that you can smoothly transition between recording, playback, and overdubbing.

When auto input is on

Channels set to Record mode (press the PLAY/REC button and then press a channel button to make it light red)

While rewinding (REW), fast-forwarding (FF), or stopped (STOP), you will hear the input signal for that channel.

During playback (PLAY), you will hear the playback of the track recorder for that channel.

During recording (REC), you will hear the input signal for that channel.

Channels set to Play mode (press the PLAY/REC button and then press a channel button to make it light green)

While rewinding (REW), fast-forwarding (FF), or stopped (STOP), you will not hear anything for that channel.

During playback (PLAY) or recording (REC), you will hear the playback of the track recorder for that channel.

When auto input is off

Channels set to Record mode (press the PLAY/REC button and then press a channel button to make it light red)

You will always hear the input signal for that channel.

Channels set to Play mode (press the PLAY/REC button and then press a channel button to make it light green)

While rewinding (REW), fast-forwarding (FF), or stopped (STOP), you will not hear anything for that channel.

During playback (PLAY) or recording (REC), you will hear the playback of the track recorder for that channel.

In this way, you can leave the Auto Input function turned on so that channels assigned to Record mode will automatically switch between recording you when record and playback at other times.

This means that you won't need to change the setting of the channel buttons to hear the channels you've recorded.

note If the Auto Input function is on, an icon is shown in the Level Meter screen (→p.20).

! If you want to practice on an instrument connected to the D888 while playing back previously-recorded tracks, you'll need to turn the Auto Input function off in order to hear the input signal. Alternatively, you can leave the Auto Input function on, and turn on the Rehearsal function (see the preceding section) so that you can hear the input signal while you practice.

Turning auto input on/off

- 1) Press the MENU button to access the Menu screen.
- 2) Use the cursor up/down buttons to select "4. Auto input".
Alternatively, you can press channel button "4" to select "4. Auto Input" instead of using the cursor up/down buttons.
- 3) Use the cursor left/right buttons to switch the setting between "ON" and "OFF".

If the setting you make differs from the current setting, a "?" symbol will appear.

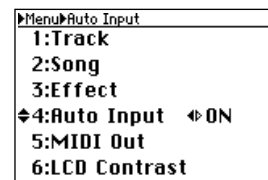

- 4) To confirm the change you made, press the ENTER/OK button.

If you decide not to make the change, press the EXIT/CANCEL button to revert to the original setting.

Playback

The D888 is able to play back eight tracks simultaneously. If the Auto Input setting is on, channels that are set to Record mode can be played simply by pressing the **PLAY** button, without your having to switch the **channel buttons** between Record and Play modes.

1. Types of playback

You can play back up to eight channel tracks simultaneously, or play back the master track that contains the stereo data you mastered.

🔊 *Even if there is no audio data, playback will continue until you press the **STOP** button.*

1-1. Playing the channel tracks

🔊 *Before you continue, select the desired virtual track for each channel you want to play (→p.26 “1. Virtual tracks”).*

- 1) **Select the track(s) that you want to hear during playback.**
Press the **CH ON** button (it will light).
Press the **channel buttons** to select On (lit orange) for the tracks that you want to play.
Press the **REC/PLAY** button (it will light).
Press the **channel buttons** to select Play (lit green) for the tracks that you want to hear during playback.
- 2) **Move to the location at which you want to begin playing** (→p.22).
- 3) **Press the PLAY button to start playback.** (The **PLAY** button will light.)
- 4) **Adjust the EQ or panning.**
- 5) **Apply an effect** (→p.33).
- 6) **Press the STOP button to stop playback.** (The **PLAY** button will go dark.)

You can use channel tracks to play back the data of virtual tracks, or you can load a master track WAV file or a WAV file loaded in USB mode (→p.39) into a channel track and play it from there.

1-2. Playing a master track

The master track (WAV file) most recently recorded will be selected. If you want to hear a master track that you recorded earlier, proceed as described in p.39 “2-4. Selecting a master track file (Master)” before you continue.

- 1) **Press the master track MASTER button to select Play mode (button lit green).**
At this time, all channel tracks will automatically turn off.
- 2) **Move to the location at which you want to begin playing** (→p.22).
- 3) **Press the PLAY button to begin playback.** (The **PLAY** button will light.)
- 4) **Press the STOP button to stop playback.** (The **PLAY** button will go dark.)

1-3. Repeat playback

This function lets you play repeatedly over the IN–OUT region of the song. This is a convenient way to check the content of that region, or you can use this function in conjunction with Auto Punch recording to record repeatedly (→p.30).

- 1) **Press the REC/PLAY MODE button to access the REC/PLAY MODE screen.**
- 2) **Use the cursor up/down buttons to select “Repeat”.**
- 3) **Press the ENTER/OK button to add a check mark to “Repeat”.**
The **REPEAT** LED of the panel will light.
- 4) **Specify the region (IN–OUT) that you want to repeat.**
- 5) **Use the cursor up/down buttons to select “In=...” and press the ENTER/OK button to access the point setting screen.**
- 6) **Use the point setting screen to specify the locate point.** Refer to “Setting the In, Out, Pre, and Post locate points” (p.29).

🔊 *You don't need to specify the “Pre=...” or “Post=...” settings when using the Repeat Playback function. These settings are used only for Repeat Recording.*

- 7) **Select the playback tracks.**
Refer to “1-1. Playing the channel tracks,” earlier on this page.
 - 8) **Perform repeat playback.**
When you press the **PLAY** button, playback will begin from the IN location and repeat over the IN–OUT region.
- 🔊 *When using repeat playback, it may take approximately one second to move from the OUT location to the IN location and continue playing.*
- 9) **Press the STOP button to stop playback.** (The **PLAY** button will go dark.)

Effects

The D888 provides eleven different effect types. The effect is shared between the channel tracks, and you can use the **EFFECT knob** of each channel track to adjust the depth of the effect.

Use the **EFFECT RTN knob** to adjust the overall amount of effect for the entire song.

You can edit the parameters of each effect, and the changes you make will also be saved when you save the song.

Effect structure

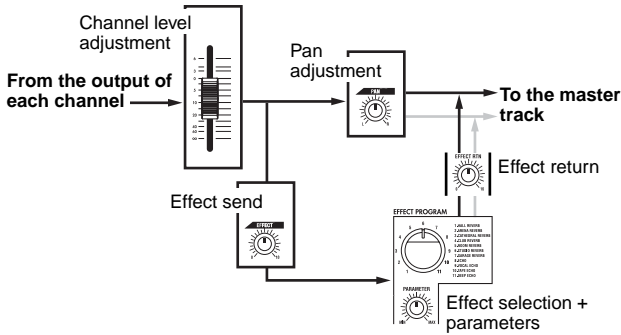

1. Using an effect

- 1) Press the **EFFECT ON** button.
- 2) Turn the **EFFECT RTN knob** all the way to the right. Turning the **EFFECT RTN knob** toward the right will increase the amount of sound processed by the effect, and turning the knob toward the left will decrease this amount.
- 3) Turn the **EFFECT knob** for each channel track to which you want to apply the effect. This adjusts the effect depth for each channel track. If the **EFFECT knob** is turned all the way toward the left, there will be no effect on that channel track (the sound will be "dry"). Turning the knob toward the right will increase the amount of effect for that channel track (making the sound "wet").
- 4) Select the effect which you want to apply with the selector.
- 5) Turn the **PARAMETER knob** to hear how the effect changes. The actual parameter assigned to the **PARAMETER knob** will depend on the effect program. (See the table at right.)

Adjust the amount sent from each channel to the effect

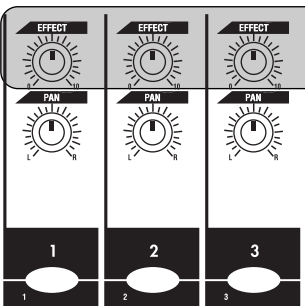

Select an effect

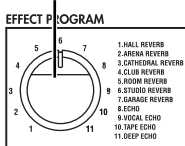

- PARAMETER — Adjust the effect
- EFFECT RTN — Amount of effect sound returned to master
- EFFECT ON — Effect on/off

2. Effect programs and parameters

1. HALL REVERB	A hall-type reverb	Reverb time	0.1...10.0 sec
2. ARENA REVERB	The reverberation of a fairly large hall.	Reverb time	0.1...10.0 sec
3. CATHEDRAL REVERB	The distinctive reverberation of a cathedral.	Reverb time	0.1...10.0 sec
4. CLUB REVERB	The reverberation of a mid-sized music club.	Reverb time	0.1...5.0 sec
5. ROOM REVERB	A room-type reverb.	Reverb time	0.1...5.0 sec
6. STUDIO REVERB	A subtle reverb such as heard in a studio.	Reverb time	0.1...5.0 sec
7. GARAGE REVERB	A loose reverb such as heard in a garage.	Reverb time	0.1...5.0 sec
8. ECHO	A conventional echo that continues repeating the sound for a while.	Delay time	0.1...4.0 sec
9. VOCAL ECHO	An echo with somewhat attenuated repeats, designed for vocals.	Delay time	0.1...4.0 sec
10. TAPE ECHO	A soft-sounding tape-type echo.	Delay time	0.1...4.0 sec
11. DEEP ECHO	An echo with strong repeats.	Delay time	0.1...4.0 sec

Level Meter screen

Song and Location

Mixer

Recording (basic)

Recording (advanced)

Playback

Operation

Effects

Editing

Other

Checking the program

When you reload or select a song that uses an effect, you also have the option of loading the effect parameter setting that were saved with that song, regardless of the physical position of the **EFFECT selector**, **PARAMETER**, and **EFFECT RTN knobs**. In this case, you can use the Effect screen to check the effect settings.

- 1) Press the **MENU** button to access the Menu screen.
- 2) Use the cursor up/down buttons to select “3. EFFECT,” and press the **ENTER/OK** button.

The Effect screen will appear.

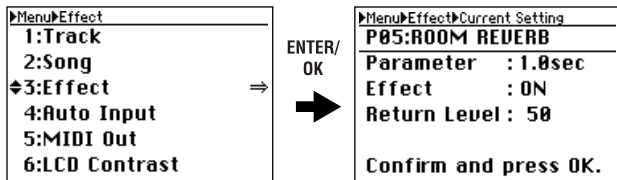

In this state when you move the **EFFECT selector** or **PARAMETER knob**, the screen will switch correspondingly.

- 3) Press the **EXIT/CANCEL** button to return to the Menu screen.

3. Saving effect settings

When you save a song that uses an effect, the current effect settings will also be saved along with the song.

When you reload or select a song, you can choose whether these settings will also be loaded. The effect settings consist of the **EFFECT program**, and the positions of the **PARAMETER knob** and **EFFECT RTN knob**.

If you load these effect settings, they will apply regardless of the physical position of the **EFFECT selector** and the **PARAMETER** and **EFFECT RTN knobs**. However when you move the selector or a knob, the setting will immediately switch to the corresponding position.

Editing

1. Song editing

1-1. Reloading a song

This operation reloads the current song in the state in which it was last saved. At this time you can choose whether the mixer settings and effect settings saved with the song will also be loaded (→p.48 “Song file details”).

⚠ The audio data you modified by recording, Track Copy, or Erase operations will not return to its former state.

- 1) Press the MENU button to access the Menu screen.
- 2) Use the cursor up/down buttons to select “2. SONG” and use the cursor left/right buttons to select “Reload”. Alternatively, you can press channel button “2” to select “2. SONG” instead of using the cursor up/down buttons.

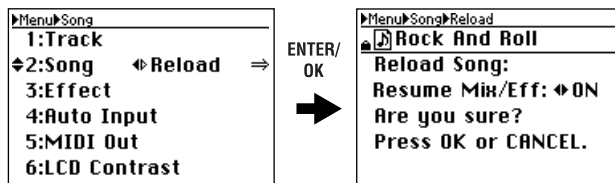

- 3) Press the ENTER/OK button. The display will indicate “Resume Mix/...”
- 4) Use the cursor left/right buttons to choose “ON” if you want the mixer and effect settings to be loaded, or “OFF” if you don’t want them to be loaded. Then press the ENTER/OK button.

⚠ If this setting is “OFF” (i.e., “don’t load the mixer and effect settings”) and the song you load is protected, these settings will be loaded anyway, just as if this setting were “ON”.

The screen will indicate “Song Reload: Working...” for a time, and then “Song Reload: Completed”.

- 5) Press the ENTER/OK button to return to the Menu screen.

1-2. Deleting a song

This operation lets you delete an unwanted song.

- 1) Press the SELECT SONG button to access the Select Song screen. A list of songs will appear, with the top line of the page showing the song that can currently be recorded or played (the “current song”).
- 2) Use the cursor left/right buttons to select “Delete” in the FUNCTION area, and use the cursor up/down buttons to select the song that you want to delete.
- 3) Press the ENTER/OK button. The song to be deleted will appear in the current song area, and the screen will ask “Delete Song: Are you sure?”

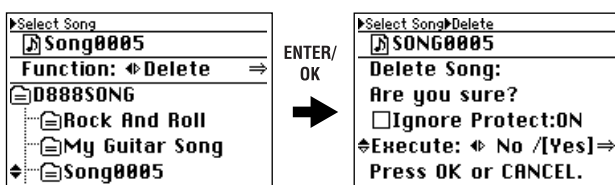

- 4) To execute the Delete Song operation, use the cursor left/right buttons to select “Yes” for the “Execute” field, and then press the ENTER/OK button once again. The screen will indicate “Delete Song: Working ...”, and when deletion is complete, will indicate “Delete Song: Completed”.

⚠ If the song you’re attempting to delete is protected, you won’t be able to delete it. In this case, check the “Ignore Protect: ON” check box before you execute the Delete Song operation.

- 5) Press the ENTER/OK button to return to the Menu screen.

⚠ If you delete the current song, the next song will be selected as the current song.

1-3. Copying a song

This operation copies (duplicates) the current song. You can use this when you want to create a different mix or arrangement of the same song.

- 1) Select the copy-source song.
- 2) Press the MENU button to access the Menu screen.
- 3) Use the cursor up/down buttons to select “2. SONG” and use the cursor left/right buttons to select “Copy”. Alternatively, you can press channel button “2” to select “2. SONG” instead of using the cursor up/down buttons.
- 4) Press the ENTER/OK button to access the Copy Song screen. If you change your mind, press the EXIT/CANCEL button to return to the Menu screen.

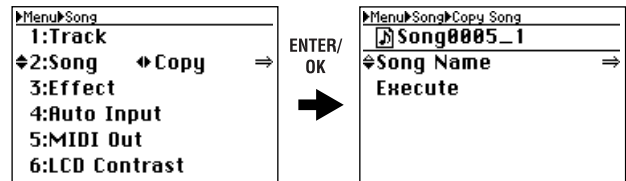

- 5) If you want to rename the copy of the song, proceed as described in “Naming the copied song” and then continue with step 6).
- 6) If you don’t need to rename the copy of the song (or if you have already renamed it), use the cursor up/down buttons to select “Execute”.

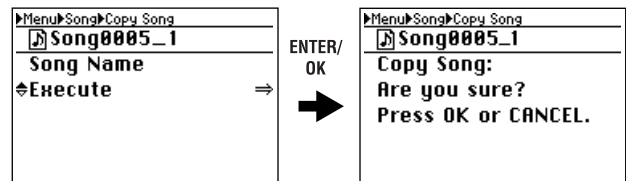

- 7) Press the ENTER/OK button. The screen will ask “Copy Song: Are you sure?”
- 8) Press the ENTER/OK button once again. The screen will indicate “Copy Song: Working...”, and then “Copy Song: Completed” when the copy is completed.

⚠ If you have not renamed the newly copied song, it will automatically be given a name consisting of the copy-source name ended by a serial number starting at 1.

- 9) Press the ENTER/OK button to return to the Menu screen.

⚠ The Undo data maintained within the song will not be copied.

Level Meter screen

Song and Location

Mixer

Recording (basic)

Recording (advanced)

Playback

Operation

Effects

Editing

Other

Naming the copied song

You can assign a song name of up to sixteen characters.

- 1) To assign a new name to the copied song, use the cursor up/down buttons to select “Song Name”.
- 2) Press the ENTER/OK button to access the renaming screen.
- 3) Use the cursor left/right buttons to select the position at which you want to change the character, and use the cursor up/down buttons to choose a character.
Alternatively, you can use the channel buttons to enter numerals directly instead of using the cursor up/down buttons.
Press the MENU button to switch between uppercase and lowercase characters.
Use the JUMP buttons to delete (DEL) or insert (INS) characters.

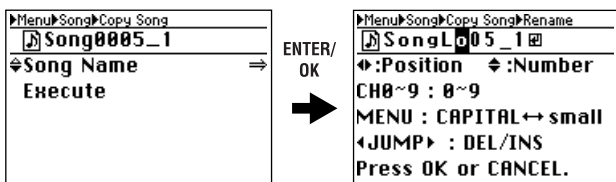

- 4) If you are satisfied with the name you edited, press the ENTER/OK button to confirm the change and return to the Copy Song screen.
If you decide not to make the change, press the EXIT/CANCEL button.

You can use uppercase characters A–Z, lowercase characters a–z, numerals 0–9, space, and the following symbols.



If you want to edit the name after copying the song, perform the Rename operation in “2: Song” (→p.21).

1-4. Saving a song

Since the D888 automatically saves song data and parameters when you perform the shut-down operation or when you select a song, it is not absolutely necessary for you to save manually.

However if the power should be interrupted by a power failure or other accident, the data that has been recorded or edited since the most recent power-on (or since a song was last selected) will be lost.

We recommend that you use this command to save the data periodically after recording or editing for an extended period, or if you are using the D888 in an environment where the power supply is unreliable.

note The song will also be saved automatically when you press the USB button to enter USB mode.

- 1) Use the cursor up/down buttons to select “2. SONG,” and use the cursor left/right buttons to select “Save Now”.
Alternatively, you can press channel button “2” to select “2. SONG” instead of using the cursor up/down buttons.

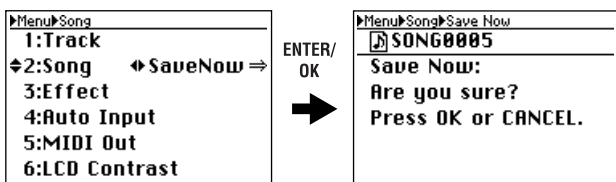

- 2) Press the ENTER/OK button, and the screen will ask “Save Now: Are you sure?”
If you decide not to save the song, press the EXIT/CANCEL button to return to the Menu screen.

- 3) Press the ENTER/OK button once again.
The screen will indicate “Save Now: Working...”, and when saving is complete, the indication will change to “Save Now: Completed”.
- 4) Press the ENTER/OK button to return to the Menu screen.

note The length of time taken by this operation until the Completed indication appears will be proportionate to the length of the song.

1-5. Protecting a song

You can protect a song so that it will not be accidentally overwritten or deleted.

If the song is protected (protect On), you won’t be able to switch to Record by pressing the MASTER button or the channel buttons when the REC/PLAY button is on. Nor will you be able to rewrite any of the parameters of that song. The song will automatically be saved when you protect it. Follow the same procedure to defeat protection (i.e., to turn protect off).

note You can change the protect setting only for the currently selected song.

- 1) Press the MENU button to access the Menu screen.
- 2) Use the cursor up/down buttons to select “2. SONG,” and use the cursor left/right buttons to select “Protect”.
Alternatively, you can press channel button “2” to select “2. SONG” instead of using the cursor up/down buttons.
- 3) Press the ENTER/OK button to access the Protect screen.
If you decide not to change the Protect setting, press the EXIT/CANCEL button to return to the Menu screen.

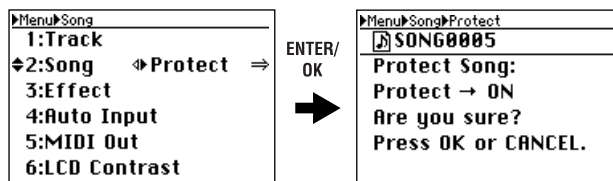

- 4) If the song is not currently protected, the screen will indicate “Protect→ON: Are you sure?” If the song is currently protected, the screen will indicate “Protect→OFF: Are you sure?”
- 5) Press the ENTER/OK button once again.
The screen will indicate “Protect Song: Working...”, and when the setting has been made, the indication will change to “Protect Song: Completed”.
- 6) Press the ENTER/OK button to return to the Menu screen.

A padlock symbol is displayed beside the song name for protected songs.

2. Track editing

The D888 provides various track editing operations that let you copy, delete, or exchange tracks. In order to copy or delete tracks, you will need to store the appropriate locate points beforehand.

note In some cases, it may be impossible to execute a track editing operation if there is insufficient free space on the song drive. In this case, you'll need to delete unneeded tracks or songs to make the necessary free space for executing the track editing operation.

2-1. Copy a track (Copy)

This command copies the specified region (IN-OUT) of track data to another location (TO). You can copy data from one track, or from two tracks simultaneously.

Here are some ways in which you can use this command.

- Copy the first verse of a song to create the second verse.
- Record a favorite phrase from a track, and copy it to a different track.

▲ Select the virtual tracks of the copy-source (SourceTrk) and copy-destination (DestTrk) before you make settings for this Copy operation.

- 1) Press the MENU button to access the Menu screen.
- 2) Use the cursor up/down buttons to select "1: Track," and use the cursor left/right buttons to select "Copy". Alternatively, you can press channel button "1" to select "1: Track" directly instead of using the cursor up/down buttons.
- 3) Press the ENTER/OK button to access the Copy Track screen. If you change your mind, press the EXIT/CANCEL button to return to the Menu screen.

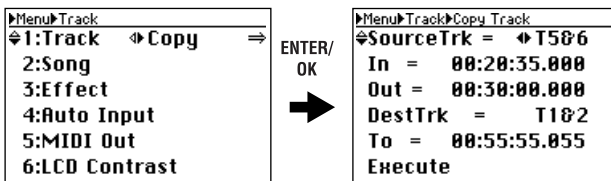

- 4) Use the cursor up/down buttons to select the parameter that you want to change, and use the cursor up/down buttons to select a setting.
- 5) For the In, Out, and To fields, press the ENTER/OK button and specify a locate point. Refer to the explanation of how to specify a locate point.
- 6) When you've finished making settings, use the cursor up/down buttons to select "Execute" at the bottom of the screen.

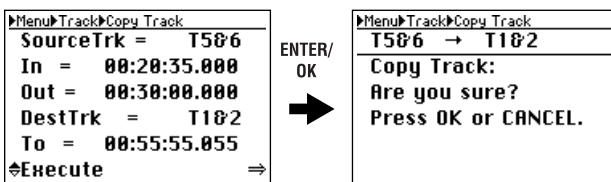

- 7) Press the ENTER/OK button. The display will ask "Copy Track: Are you sure?" If you decide to cancel, press the EXIT/CANCEL button to return to the Copy Track screen.
- 8) Press the ENTER/OK button once again. The screen will indicate "Copy Track: Working...", and when the operation is finished, will indicate "Copy Track: Completed".
- 9) Press the ENTER/OK button to return to the Copy Track screen, and press the Menu button to return to the Menu screen.

Parameters

SourceTrk (copy-source track)	T1...T8, T1&T2...T7&T8
In (start copying here)	any desired location
Out (stop copying here)	any desired location, but In < Out
DestTrk (copy-destination track)	T1...T8, T1&T2...T7&T8
To (copy to this location in the destination)	any desired location

- ▲** Any track data in the destination will be overwritten.
- ▲** This operation will take more time if the track is longer.
- ▲** You must specify the same number of tracks for "SourceTrk" and "DestTrk".
- ▲** If you change your mind, you can use Undo to revert to the previous state of the data (→p.41).
- note** Play back from the To location to verify that the operation was executed correctly.

Setting the locate points

To set a locate point, you can either use numeric input in the point setting screen, or store marks beforehand and use these marks.

note You can also select a mark and then edit its numerical value to adjust the location.

Using numeric input

- 1) Use the cursor up/down buttons to select "In=..." (or "Out=...", "To=..."), and press the ENTER/OK button to access the point setting screen.
- 2) Use the cursor left/right buttons to select the digit you want to edit, and use the cursor up/down buttons to select a numeric value. Alternatively, you can use the channel buttons to enter numeric values directly, instead of using the cursor up/down buttons. By pressing the STORE button at this time, you can specify the current location as the point.

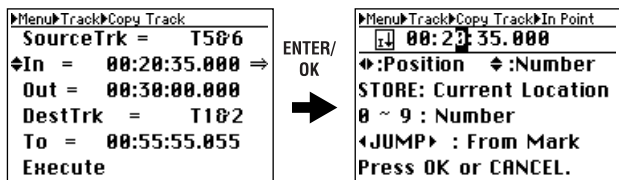

- 3) When you're finished entering the point, press the ENTER/OK button to confirm your entry.

Using marks

- 1) Use the cursor up/down buttons to select "In=..." (or "Out=...", "Post=..."), and press the ENTER/OK button to access the point setting screen.
- 2) Use the JUMP buttons to select the stored mark that corresponds to the desired locate point. You can use step 2) of "Using numeric input" to adjust the value if desired.
- 3) Press the ENTER/OK button to confirm your entry.

Level Meter screen

Song and Location

Mixer

Recording (basic)

Recording (advanced)

Playback

Operation

Effects

Editing

Other

2-2. Erase a track (Erase)

This command erases track data from the specified region (IN-OUT) of a track. The region will become blank. This Erase Track command will not cause the data following the OUT point to move.

- You can also erase the IN through OUT region of a pair of two tracks.

⚠ Before you make settings for this operation, check the virtual track of the **DestTrk** track from which you will be erasing data.

- Press the **MENU** button to access the Menu screen.
- Use the cursor up/down buttons to select “1: Track,” and use the cursor left/right buttons to select “Erase”. Alternatively, you can select “1. Track” by pressing channel button “1” instead of using the cursor up/down buttons.

- Press the **ENTER/OK** button to access the Erase Track screen. If you change your mind, press the **EXIT/CANCEL** button to return to the Menu screen.

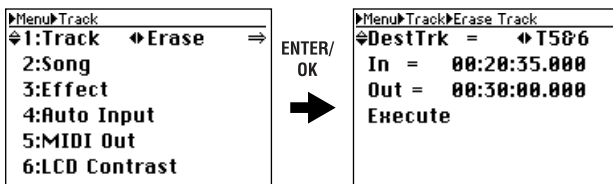

- Use the cursor up/down buttons to select the parameter you want to change, and use the cursor left/right buttons to select the value.

- To make the In and Out settings, press the **ENTER/OK** button and specify the appropriate locate points. For details, refer to the section on how to set locate points.

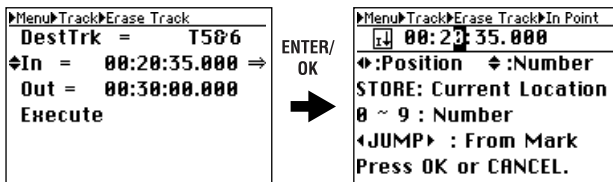

- When you’ve finished making settings, use the cursor up/down buttons to select “Execute” in the bottom line.

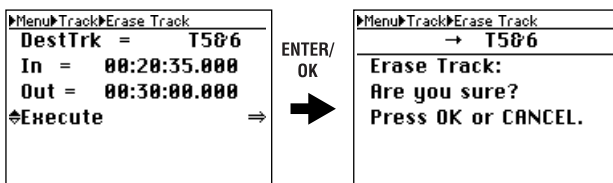

- Press the **ENTER/OK** button. The display will ask “Erase Track: Are you sure?” If you change your mind, press the **EXIT/CANCEL** button to return to the Erase Track screen.
- Press the **ENTER/OK** button once again. The screen will indicate “Erase Track: Working...”, and when the operation is completed, will indicate “Erase Track: Completed”.
- Press the **ENTER/OK** button to return to the Erase Track screen, and press the **Menu** button to return to the Menu screen.

Parameters

DestTrk (track to erase)	T1...T8, T1&T2...T7&T8
In (start erasing here)	any desired location
Out (stop erasing here)	any desired location, but In < Out

⚠ This operation will take longer in proportion to the length of the track.

⚠ If you change your mind, you can use **Undo** to revert to the previous state of the data (→p.41).

⚠ Play back from the **In** location to verify that the operation was executed correctly.

2-3. Exchanging tracks (Swap)

This operation exchanges (swaps) track data between the two channels you specify.

⚠ Before you make swap settings for the tracks, you should verify that the appropriate virtual track is selected for the swap source (**SourceTrk**) and swap destination (**DestTrk**).

- Press the **MENU** button to access the Menu screen.
- Use the cursor up/down buttons to select “1: Track,” and use the cursor left/right buttons to select “Swap”. Alternatively, you can select “1. Track” by pressing channel button “1” instead of using the cursor up/down buttons.

- Press the **ENTER/OK** button to access the Swap Track screen. If you change your mind, press the **EXIT/CANCEL** button to return to the Menu screen.

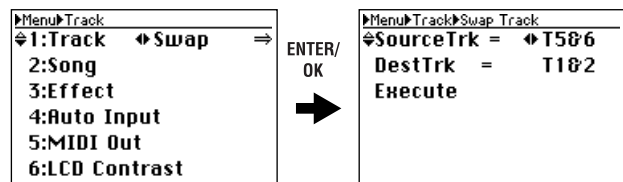

- Use the cursor up/down buttons to select the parameter you want to change, and use the cursor left/right buttons to select the value.

- When you’ve finished making settings, use the cursor up/down buttons to select “Execute” in the bottom line.

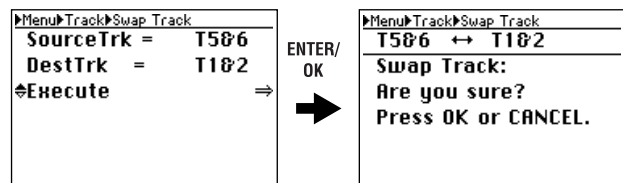

- Press the **ENTER/OK** button. The display will ask “Swap Track: Are you sure?” If you change your mind, press the **EXIT/CANCEL** button to return to the Swap Track screen.
- Press the **ENTER/OK** button once again. The screen will indicate “Swap Track: Working...”, and when the operation is completed, will indicate “Swap Track: Completed”.
- Press the **ENTER/OK** button to return to the Swap Track screen, and press the **Menu** button to return to the Menu screen.

Parameters

SourceTrk (swap source track)	T1...T8
DestTrk (swap destination track)	T1...T8

⚠ If you change your mind, you can use **Undo** to revert to the previous state of the data (→p.41).

⚠ Play back the tracks you swapped to verify that the operation was executed correctly.

2-4. Selecting a master track file (Master)

The most recently created master track recording will be selected as the current master track. However, you may also select and play master track recordings that you made earlier. You can also select and play WAV files that you loaded into the D888 using USB mode. However, you can only select WAV files (44.1 kHz 16-bit, stereo only) that are in the same folder as the current song.

- 1) Press the MENU button to access the Menu screen.
- 2) Use the cursor up/down buttons to select "1: Track," and use the cursor left/right buttons to select "Master". Alternatively, you can select "1. Track" by pressing channel button "1" instead of using the cursor up/down buttons.
- 3) Press the ENTER/OK button to access the Master Play File screen. If you change your mind, press the EXIT/CANCEL button to return to the Menu screen.

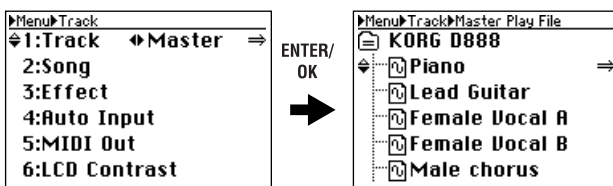

- 4) Use the cursor up/down buttons to select a WAV file.
- 5) Press the ENTER/OK button, and the display will ask "Select Wav File: Are you sure?" If you change your mind, press the EXIT/CANCEL button to return to the Master Play File screen.

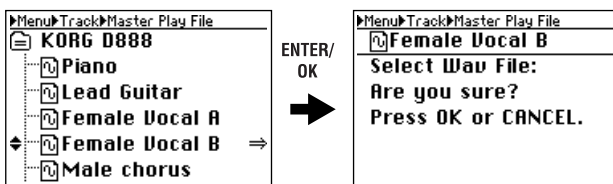

- 6) Press the ENTER/OK button once again. The screen will indicate "Select Wav File: Working...", and then "Select Wav File: Completed" when the operation is completed.
- 7) Press the ENTER/OK button to return to the Menu screen.

44.1 kHz 16-bit stereo WAV files are the only type of files you can select. An error message will appear if you attempt to select a file of any other format. If an error message is displayed, press the ENTER/OK button to return to the Master Play File screen.

2-5. Selecting a channel track file (VTrack)

Here's how to select the file that is assigned to each channel track.

You can select a virtual track (VT1-VT8), a master track WAV file, or a WAV file that you loaded into the D888 using USB mode. However, you can only select WAV files (44.1 kHz 16-bit) that are in the same folder as the current song.

Note You can't use a file that is already selected for the master track.

Selecting a virtual track

Refer to p.26 "1-1. Selecting virtual tracks".

Selecting a WAV file

Note You can't record or edit a track for which you've selected a WAV file. In order to record or edit, you must select a virtual track (VT1-VT8).

Note To select a mono WAV file, it must be named using the automatic D888 naming conventions (TRK01VT1.WAV, TRK01VT2.WAV,... TRK08VT8.WAV). These files can be renamed by connecting the D888 to a computer via USB. Once they are named in this way, the D888 will see them as virtual tracks. Refer to p.26 "1-1. Selecting virtual tracks"

Note If you select a stereo WAV file, the file will be assigned to the adjacent pair that includes the selected track (1-2, 3-4, 5-6, 7-8).

Note You can't use a file that is already selected for another track.

- 1) Press the MENU button to access the Menu screen.
- 2) Use the cursor up/down buttons to select "1: Track," and use the cursor left/right buttons to select "V.Track". Alternatively, you can select "1: Track" by pressing channel button "1" instead of using the cursor up/down buttons.
- 3) Press the ENTER/OK button to access the Virtual/Wav screen.

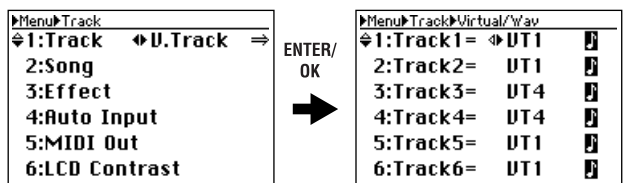

- 4) Use the cursor up/down buttons to select the track to which you want to assign the WAV file, and use the cursor left/right buttons to select "WavST?". Alternatively, you can select a track by pressing a channel button 1-8 instead of using the cursor up/down buttons.

If you change the selection of a track for which a file is already selected, a "?" symbol will appear when you select the file name.

- 5) Press the ENTER/OK button to access the Wave File screen.
- 6) Use the cursor up/down buttons to select a WAV file.

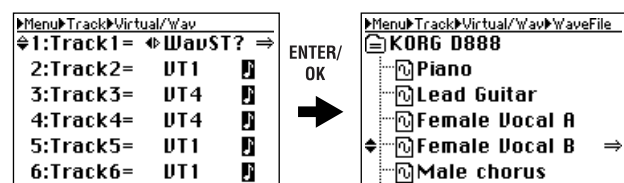

- 7) Press the ENTER/OK button. The screen will ask "Select Wav File: Are you sure?" If you change your mind, press the EXIT/CANCEL button to return to the Virtual/Wav screen.

- 8) Press the ENTER/OK button once again. The screen will indicate "Select Wav File: Working...", and then "Select Wav File: Completed" when the operation is completed.

Note Since the selected WAV file is stereo, tracks 1-2, 3-4, 5-6, or 7-8 will be the L and R channels respectively.

- 9) Press the ENTER/OK button to return to the Virtual/Wav screen.
- 10) When all changes have been finalized and there are no "?" symbols shown in the Virtual/Wav screen, press the EXIT/CANCEL button (or the Menu button) to return to the Menu screen.

2-6. Deleting track data (Delete)

You can use this operation to delete the data of virtual tracks that are not currently selected for channel tracks 1 through 8, and WAV files other than the one that is currently selected for the master track.

By deleting unwanted data you can increase the free space (the remaining recordable time) on the hard drive.

▲ If you select master tracks for deletion, all WAV files not assigned to the master track or to a channel track will be deleted.

▲ You can't use Undo to reverse the result of this operation. Be careful not to delete any important track data.

- 1) Press the MENU button to access the Menu screen.
- 2) Use the cursor up/down buttons to select "1: Track," and use the cursor left/right buttons to select "Delete". Alternatively, you can select "1: Track" by pressing channel button "1" instead of using the cursor up/down buttons.
- 3) Press the ENTER/OK button to access the Delete Unused V.Track screen. If you change your mind, press the EXIT/CANCEL button to return to the Menu screen.

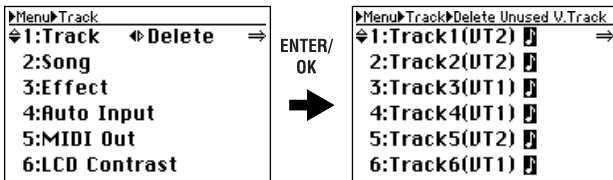

- 4) Use the cursor up/down buttons to select the track or master track whose unused virtual track data you want to delete. As an alternative to using the cursor up/down buttons, you can press a channel button 1–8 or the MASTER button to make your selection.
- 5) Press the ENTER/OK button. The display will ask "Delete Unused V.Track: Are you sure?" If you change your mind, press the EXIT/CANCEL button to return to the Delete Unused V.Track screen.

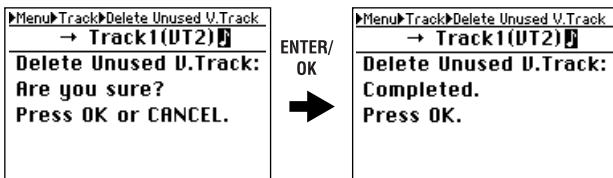

- 6) Press the ENTER/OK button once again. The display will indicate "Delete Unused V.Track: Working..." When the deletion is completed, you will return to the Delete Unused V.Track screen.

note If the track you selected only contains data for the currently-used virtual track, an error message will appear. Press the ENTER/OK button to return to the Delete Unused V.Track screen.
- 7) When you've finished deleting unwanted track data, press the EXIT/CANCEL button (or the Menu button) to return to the Menu screen.

Other

1. Adjusting the contrast

If you find the display difficult to read, you can adjust the contrast.

- 1) Press the MENU button to access the Menu screen.
- 2) Use the cursor up/down buttons to select "6. LCD Contrast". Alternatively, you can select "6: LCD Contrast" by pressing channel button "6" instead of using the cursor up/down buttons.
- 3) Use the cursor left/right buttons to adjust the contrast setting. When you modify the setting, a "?" symbol will appear after the value. If you change your mind, press the EXIT/CANCEL button; the "?" will disappear and you will revert to the previous contrast setting.

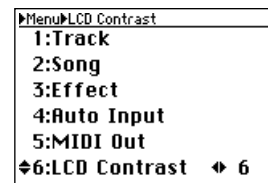

- 4) Press the ENTER/OK button. The "?" following the value will disappear, and the new contrast setting will be applied.

2. Using a foot switch

You can use a foot switch (we recommend the optional Korg PS-1 pedal switch) to switch between punch-in and punch-out when performing manual punch recording. Connect your foot switch to the FOOT SW jack. You will need to specify the correct polarity for the foot switch you're using.

note You don't need to specify the polarity if you're using a Korg PS-1 pedal switch.

Specifying the foot switch polarity

- 1) Press the MENU button to access the Menu screen.
- 2) Use the cursor up/down buttons to select "7. Foot Switch," and press the ENTER/OK button. Alternatively, you can select "7: Foot Switch" by pressing channel button "7" instead of using the cursor up/down buttons.
- 3) Connect the foot switch you want to use to the FOOT SW jack.
- 4) Use the cursor left/right buttons to specify the polarity.
- 5) Specify the polarity that makes the "Check status" ON indication appear when you press your foot switch.

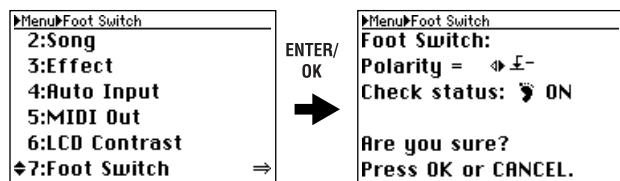

- 6) To confirm the change, press the ENTER/OK button. You will return to the Menu screen. If you decide not to change the setting, press the EXIT/CANCEL button to maintain the existing setting.

3. Undo and Redo

When the **UNDO** or **REDO LED** is lit, you can cancel the preceding operation or revert to the state prior to cancelling. Undo and Redo let you revert only the single most recently executed operation.

Undo and Redo are available for the following operations.

- Channel track recording (→p.27)
- Overdub recording (→p.27)
- Bounce recording (→p.27)
- Master track recording (→p.28)
- Track copy (→p.37)
- Track erase (→p.38)
- Track swap (→p.38)

The undo and redo data is erased when you perform Song Select or Reload (the **UNDO** and **REDO LEDs** will go dark).

Examples

- Copy a track

- 1) Copy a track (→p.37 “2-1. Copy a track (Copy)”).
- 2) The **UNDO LED** will light.
- 3) Press the **UNDO/REDO** button.
- 4) The **UNDO LED** will go dark, and the **REDO LED** will light.
- 5) The track copy operation will be cancelled.

In this way, Undo will cancel the preceding operation, but you can use Redo to bring back the cancelled operation.

- Bring back the cancelled track copy operation

- 1) Make sure that the **REDO LED** is lit.
- 2) Press the **UNDO/REDO** button.
- 3) The **REDO LED** will go dark and the **UNDO LED** will light.
- 4) The data will return to its state before you executed **Undo**.

If you execute a new operation while the **REDO LED** is lit, the **REDO LED** will go dark and the **UNDO LED** will light. Undo will cancel the most recently performed operation, but Redo will cancel the operation only if you executed Undo.

4. Formatting the drive

This operation will format the D888’s hard disk drive. You should execute this operation if you want to erase all the data stored on the drive, or if a “**Drive error occurred**” message appears frequently.

Remember that all data on the drive will be erased when you execute the Format operation, so please be sure that you’re not erasing any data you need to keep. If necessary, you can make a backup before you execute this operation. (→“5. Connecting to a computer,” below)

note If the power is turned off accidentally while the drive is being formatted, it is possible that the D888 may stop operating correctly.

- 1) Press the **MENU** button to access the Menu screen.
- 2) Use the cursor up/down buttons to select “8. HDD Format”.
Alternatively, you can select “8. HDD Format” by pressing channel button “8” instead of using the cursor up/down buttons.
- 3) Press the **ENTER/OK** button.
The screen will ask “HDD Format: All Data... Are you sure?”

If you decide not to format the drive, press the **EXIT/CANCEL** button to return to the Menu screen.

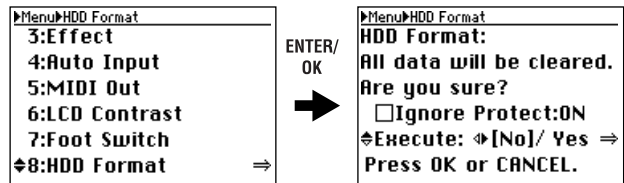

- 4) To format the drive, use the cursor left/right buttons to select “Yes” for the “Execute” field, and then press the **ENTER/OK** button once again.
The screen will indicate “HDD Format: Working...”, and then “HDD Format: Completed” when formatting is complete.

⚠ You won’t be able to format the drive if the D888’s hard disk contains even one protected song. In this case, check the “Ignore Protect: ON” check box before you execute the HDD Format operation.

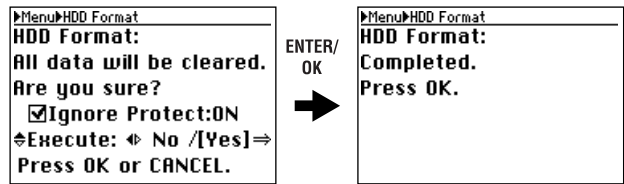

- 5) Press the **ENTER/OK** button to return to the Menu screen.

5. Connecting to a computer

⚠ You cannot connect USB peripheral devices such as an external hard disk or CD-R/RW drive to the D888.

The D888 has a **USB connector** that lets you connect it directly to your computer so that you can save data from the D888’s hard drive onto your computer or write data from your computer to the D888’s hard drive.

When you connect the D888 to your computer and enter USB mode, you’ll be able to perform the following operations.

- Copy track data (WAV) to your computer.
- Copy WAV files from your computer to the D888
- Rename folders or files (some restrictions apply)
- Back up your data
- Update the system software
- Use the D888 as an external drive for your computer
- Defrag the hard drive

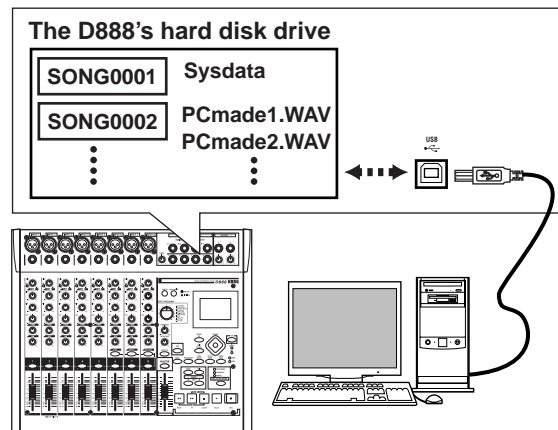

Level Meter screen

Song and Location

Mixer

Recording (basic)

Recording (advanced)

Playback

Operation

Effects

Editing

Other

5-1. USB mode

note If you power-on the D888 with it already connected to your computer via a USB cable, it will enter USB mode immediately after displaying the opening screen.

Windows users (Windows Me/2000 or later)

In order to use the D888 with Windows 98, you must install a device driver. For details on obtaining and installing the device driver, refer to the Korg website (<http://www.korg.com>).

note The computer screen will differ depending on your system. The screens shown here are for Windows XP.

- 1) Use a USB cable to connect the D888 to your computer. Connect the USB cable from your computer to the D888's USB connector. Make sure that the connector is oriented correctly, and press it all the way in.

▲ Before you make this connection, turn on your computer and start up the operating system.

- 2) Press the USB button to access the USB screen.

▲ Don't disconnect the USB cable or turn your computer on/off while this screen is shown.

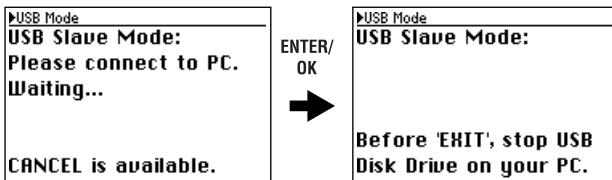

- 3) A drive named "Local disk (*)" will appear on your computer.

note When you connect the D888 to your computer for the first time, a device driver will be installed.

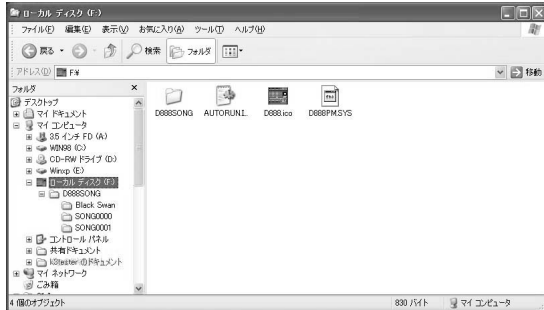

- 4) Use your computer to save the data. When you open the "Local disk (*)" drive that appeared in step 3), you will see the contents of the PC drive area within the D888's internal hard drive.

Copy the desired data onto your computer. You may also copy data from your computer back to the D888's internal hard drive.

- 5) Disconnect the D888 from your computer. Left-click the () icon that is displayed in the right side of your computer's taskbar.

From the menu that appears, left-click "Stop USB disk drive (drive name)". Verify that you see a message of "Safely remove USB Mass Storage Device".



- 6) Press the USB button or disconnect the USB cable to return to the previous screen.

note If you leave the D888 connected to your computer via the USB cable, the USB screen will appear when you power-on the D888, and it will be in USB mode.

▲ If you are using Windows Me, "USB high capacity storage device" will be displayed as "USB disk".

Macintosh users (Mac OS9.0.4 or later)

- 1) Use a USB cable to connect the D888 to your computer. Connect the USB cable from your computer to the D888's USB connector. Make sure that the connector is oriented correctly, and press it all the way in.

- 2) Press the USB button to access the USB screen.

▲ Don't disconnect the USB cable or turn your computer on/off while this screen is shown.

- 3) A drive named "Unnamed" will appear on the desktop of your computer.

note When you connect the D888 to your computer for the first time, a device driver will be installed.

- 4) Use your computer to save the data.

When you open the "Unnamed" drive that appeared in step 3), you will see the contents of the D888's internal hard drive. Copy the desired data onto your computer. You may also copy data from your computer back to the D888's internal hard drive.

- 5) Drag the added drive into the trash.

When you want to disconnect the D888, either drag the drive from the desktop into the trash, or select the "File" menu command "Put Away".

- 6) Press the USB button or disconnect the USB cable to return to the previous screen.

note If you leave the D888 connected to your computer via the USB cable, the USB screen will appear when you power-on the D888, and it will be in USB mode.

5-2. Files you can use

Your computer will recognize the D888's drive as an externally attached drive named "Local disk (*)" (or "Unnamed").

This disk contains a folder named **D888SONG**. A folder for each song will be created within this folder.

The song folder contains performance data files (WAV files) and a song setting file.

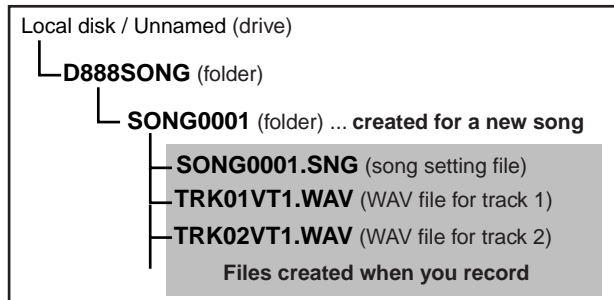

You can copy these folders and files to your computer to back them up as needed.

WAV files that meet the D888's file conditions can also be copied from your computer, and you can use your computer to rename folders and files.

For details on the file conditions and hierarchy that the D888 can recognize, refer to "File details" on page 47.

6. Synchronization via MIDI

MIDI stands for Musical Instrument Digital Interface, and is a world-wide standard used to exchange performance data between electronic musical instruments and computers.

6-1. MIDI connections

Use only MIDI cables to transfer MIDI data. Connect these cables between the MIDI connector of the D888 and the MIDI connectors of the external MIDI device with which you want to transfer data.

MIDI OUT connector

Transmits MIDI messages from the D888. Connect this to the MIDI IN connector of the external device.

6-2. MIDI messages used by the D888

Since the D888 will transmit MTC (MIDI Time Code), it can operate in synchronization with an external sequencer or recorder.

The frame rate is 30 fps, and the MTC format is 30 NDF.

 *The D888 can operate as the master, but not as a slave.*

About the MIDI implementation chart

The owner's manual of each MIDI device includes a MIDI implementation chart. This chart shows the types of MIDI message that the device can transmit and receive. When using two MIDI devices together, compare their MIDI implementation charts to verify that the devices will be able to communicate as you expect.

* A detailed explanation of the D888's MIDI functionality can be found in the separate MIDI implementation. Consult your local Korg distributor for more information on MIDI Implementation.

6-3. MIDI synchronization settings

Here's how to select whether you will synchronize an external MIDI device to the D888. If you're not using synchronization, choose the "OFF" setting to avoid malfunctions.

- 1) Press the MENU button to access the Menu screen.
- 2) Use the cursor up/down buttons to select "5. MIDI Out".
Alternatively, you can select "5. MIDI Out" by pressing channel button "5" instead of using the cursor up/down buttons.
- 3) Use the cursor left/right buttons to select "ON" or "OFF".
If you've changed the current setting, a "?" symbol is shown.



- 4) To accept the change, press the ENTER/OK button to confirm it.
If you decide not to change the setting, press the EXIT/CANCEL button to maintain the original setting.

7. Upgrading the system

7-1. Downloading the operating system

The most recent operating system can be downloaded from the Korg website (<http://www.korg.com>). For details on the procedure, refer to the Korg website.

Preparations for updating the system

Use a USB cable to connect the D888 to your computer (refer to p.42 "5-1. USB mode"), and copy the downloaded system file to the root directory (or folder) of the KORG D888 hard drive.

7-2. Updating the system

If the power is turned off accidentally while the system is being loaded, the D888 may stop operating correctly. If this occurs, please contact Korg customer service.

- 1) Press the MENU button to access the Menu screen.
- 2) Use the cursor up/down buttons to select "System Load".
- 3) Press the ENTER/OK button.
The screen will indicate "System Load: Are you sure?"

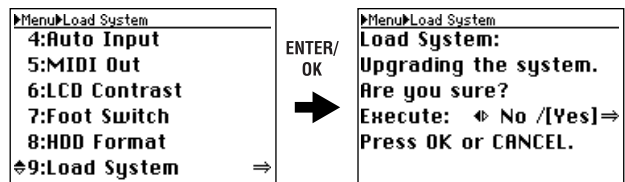

- 4) To execute the Load System operation, use the cursor left/right buttons to select "Yes" for the "Execute" field, and then press the ENTER/OK button once again.
The display will indicate "System Load: Working..." and loading will begin.
- 5) When system load is complete, the display will indicate "System will shut down. Press OK".

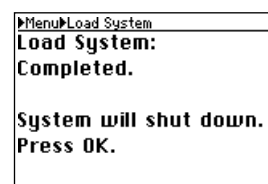

- 6) Press the ENTER/OK button.
The D888 will shut down and enter standby mode (the STANDBY LED will light).
- 7) Press the ON button to turn on the power.
The D888 will start up with the system you loaded.

 *If the update process fails, a message will appear. Take the appropriate action for the message that appears (→p.45 "Various messages").*

Level Meter screen

Song and Location

Mixer

Recording (basic)

Recording (advanced)

Playback

Operation

Effects

Editing

Other

Appendices

Troubleshooting

Power does not turn on

- Is the power cable connected to an outlet? (→p.6)
- Is the rear panel POWER ON (power supply) switch turned on? (→p.6)

Nothing appears in the display

- Is the top panel on button lit? (→p.6, p.11)
- Is the contrast adjusted correctly? (→p.40)

Vertical lines are visible in the display

- Depending on the content of the display, vertical lines may be visible in the display, but this is not a malfunction.
→ If the screen is difficult to read, adjust the contrast (→p.40).

No sound

- Is the power of the D888 or a connected device turned off? (→p.7)
- Is the MASTER fader, monitor LEVEL knob, or PHONES level knobs set to low?
- Is the each channel volume level set to low?

Can't hear the playback

- With the REC/PLAY button on, are the channel buttons set to Play mode for the appropriate tracks? (→p.10)
- With the CH ON button on, are the channel buttons turned On? (→p.10)

Input sound is inaudible or too soft

- Is the TRIM knob raised to an appropriate level?
- Verify that audio is being input.
→ Press the LEVEL METER button to access the Level Meter screen.
Press the EXIT/CANCEL button to select the input level meter display, and verify that an audio signal is being input (→p.16, p.20).
- With the REC/PLAY button on, are the channel buttons set to Record mode? (→p.10)
- Are the monitor settings appropriate?
- With the CH ON button on, are the channel buttons turned On? (→p.10)
- Is the Auto Input setting turned on? (→p.20, p.31)
→ If Auto Input is turned on, you won't hear the input audio during playback.

Can't record

- Is the recording-destination track's REC/PLAY button set to REC?
- Is the CH ON button turned on? (→p.10)
- Is the song protect setting on? (→p.20, p.36)

- Is there enough space on the drive?
→ Set the counter display to "FreeTime," and check the available recording time. (→p.20)
→ Increase the free space on the drive by deleting unwanted songs or songs you have already backed up. (→p.35)
- Is the REC/PLAY MODE appropriate? (→p.29)

The input or recorded sound is noisy or distorted

- Is the TRIM knob set appropriately? The sound will be distorted if the TRIM knob is set too high, and there will be more noise if it is set too low.
→ Press the LEVEL METER button to access the Level Meter screen.
To adjust the level optimally, press the EXIT/CANCEL button to select the input level meter display, and use the INPUT 1-INPUT 8 TRIM knobs to adjust the level as high as possible without allowing the clip indicator of the meter to light.
- Are you using effects?
→ Some effects add distortion or noise. Verify that there is no distortion or noise when you are not using an effect.
- If the effect output is distorted, make the following adjustments.
→ Use the EFFECT knob of each channel track to lower the effect level.
→ Use the EFFECT RTN knob to lower the effect return.
- If the sound is distorting in the EQ, make the following adjustments.
→ Adjust the EQ gain values (→p.25).

Effects do not apply

- Is the EFFECT ON button on?
- Is the EFFECT knob of each channel set to "0" or near "0"?
→ Raise the send level (EFFECT knob) of the channels for which you want to use the effect.
- Is the EFFECT RTN knob set to "0" or near "0"?
→ Raise the effect return level (EFFECT RTN knob) that is sent to the master track.

Metronome

Metronome does not sound

- Is the METRONOME button off (dark)?
→ In the Metronome screen, add a check mark to "Use Metronome".
- Is the "Volume" setting lowered in the Metronome screen?
- Is the recorder stopped?
→ Press the PLAY button to start playback. The metronome will sound while the recorder is recording or playing.

Metronome is heard from the master outputs

- In the Metronome screen, is the "Assign" setting "MST&MON"?
→ Set the "Assign" setting to "MONITOR".

A button does not function when pressed

- Some buttons do not function while the recorder is playing or recording.
→ Stop the recorder, and then perform the operation.
- Are you in a setting screen?
→ Press the **ENTER/OK button** or **EXIT/CANCEL button** to move to a different screen.

MIDI

MIDI sequencer won't synchronize/MIDI control is not possible

- Are the MIDI cables connected correctly? (→p.12, p.43)
- A MIDI cable may be broken.

Can't synchronize via MTC

- Is the MTC setting turned off?
- Are the synchronization settings of your MIDI sequencer appropriate?
→ Refer to the owner's manual of your MIDI sequencer.

Audio files

Can't play back

- Is the audio file format supported? (→p.47)

USB

Computer does not recognize the D888

- Is the USB cable connected correctly? (→p.12)
- Is the D888 set to USB mode? (→p.42)
- Recognition may also fail on some models of Macintosh for specific versions of the operating system. In this case, leave the D888 in USB mode, and disconnect and then reconnect the USB cable so that the D888 will be recognized.

Error occurred when you disconnected the D888 from the computer

- Use the correct procedure to disconnect. (→p.42)

When you connected the D888, the computer asked you to install software or a device driver

- Does the operating system of your computer support the D888? (→p.42)

Various messages

The message dialog box will disappear when you press the **ENTER/OK button**.

Canceled.

- Execution was canceled due to a user operation.

Cannot execute.

- This operation cannot currently be executed.

Check Sum Error.

- The system update has failed.
→ Try the update procedure once again from the beginning. If this message still appears, please contact your Korg distributor.

Completed.

- The operation has been completed successfully.

Disk too busy.

- This message will appear if repeated punch-in/out recording or track editing operations have fragmented the data on the disk, slowing down access to the hard drive.
→ Connect the D888 to your computer in USB mode and perform the Optimize command.

⚠ *In some cases, ultra-low frequencies played back in the studio may cause "Disk too busy" messages to appear. In this case, eliminate the problem by relocating the D888 before you execute the Check Drive operation.*

Drive Error.

- An error has occurred while accessing the drive.
→ Connect the D888 to your computer in USB mode and perform the check drive command.
If error messages are still displayed after you execute the check drive command, please format the drive.

Drive Full.

- There is not enough free space on the drive.
→ Delete unneeded virtual tracks or unneeded songs.

Failed to write System File.

- System updating has failed.
→ It is possible that the D888 has malfunctioned. Please contact your Korg distributor.

IN-OUT Error.

- The operation cannot be executed because there is a problem with the IN and OUT locations specified for track editing or loop playback.
→ The IN and OUT locations are the same, or the OUT location is earlier than the IN location.
→ When using the Erase Track operation, the IN position is later than the end of the track.

Memory Full.

- You attempted to register more than 100 marks. No further marks can be registered.
→ Delete unneeded marks, and then register other marks as necessary.

No REC tracks.

- None of the tracks have been set to the record ready mode.



Not supported file.

- This is an unsupported file format.
- Check the WAV file formats that are supported.

Song error.

- The song data contains an error, and cannot be selected or saved.
- Delete the song that cannot be selected.

Song Name Error.

- An identically-named song already exists.
- Change the song name. Alternatively, use USB mode to delete the directory that has the same name as the song.

System File Error.

- Either the necessary system file for “**Load System**” does not exist, or the length of the file is incorrect.
- Check the system file and re-save it.

Time Limit.

- The maximum continuous recording time is 6 hours. It is not possible to continuously record for longer than this.
- Executing the track editing operation would cause the ending location of the song to exceed the allowable song length.
- A song cannot be more than 05:59:59.999 in length.

Too many REC tracks.

- You can punch-record a maximum of two tracks.

Confirmation messages

Info: “*****”

- This will appear when there is information to be conveyed to the user.
- Press the **ENTER/OK button** and continue operation.

Serious error messages

Fatal: “*****”

- This will appear if a problem or malfunction has occurred on the D888.
- If this type of message appears, write down the contents of “*****” and contact your Korg distributor.

File details

The structure of the D888's hard drive

When the D888 is connected in USB mode, your computer will recognize its hard drive as a drive named Local Disk (or Unnamed).

From your computer, you can copy, move, delete, or rename the folders and files on the D888's hard drive.

Type of file	Available operations
WAV files	Copy, move, delete, rename
Song setting files	Copy, rename

Supported formats

FAT 32 file system, long file names are supported, double-byte characters (such as Japanese) are not supported.

KORG D888 has the following structure.

Folder/file structure

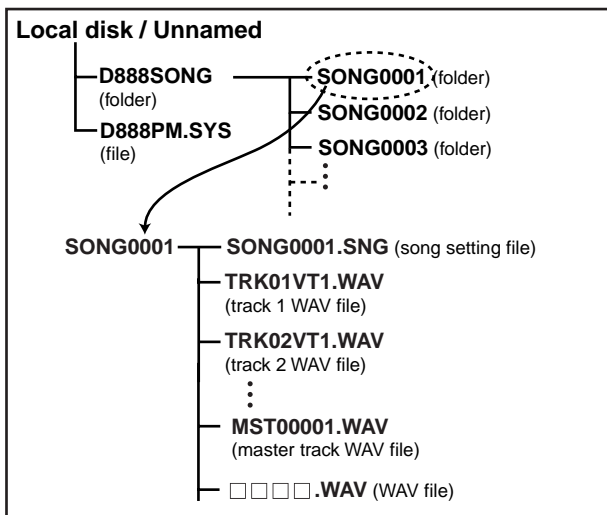

D888SONG folder

This folder contains the song data. You can create song folders within this folder as long as the remaining capacity of the hard drive will allow.

The D888 can only recognize data that is in this folder.

D888PM.SYS

This file contains settings used by the system. There must always be one and only one of this file. Do not move or delete it.

SONG0001 folder (song folders)

There will be one of these folders for each song you create. When you create a new song, a folder will be created sequentially, starting with SONG0001.

When you rename a song on the D888, the name of the song setting file in the folder will also change automatically.

▲ If you use a computer connected in USB mode to rename a song folder, you don't necessarily have to rename the song setting file (***.SNG) located inside that folder to a matching name.

Files inside a song folder

SONG0001.SNG (song setting file)

This file is specific to the D888, and contains settings for each individual song (mixer, effect, and recording settings, etc.). Only one file with a .SNG extension may exist in a song folder. You are free to rename the song settings file, but you should avoid doing so, since malfunctions may occur if two or more such files exist.

TRK01VT1.WAV (track WAV files)

These are audio files for each track. The portion of the name preceding the filename extension (.WAV) is automatically created at the time of recording according to the following conventions.

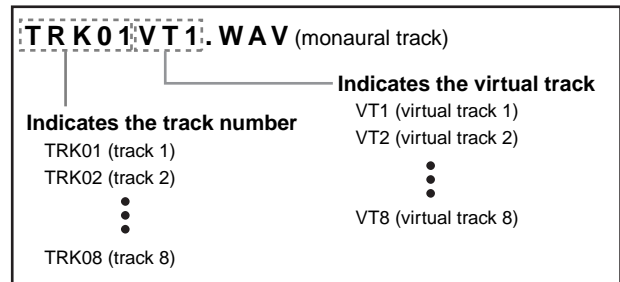

If you want to assign mono WAV files that were not created on the D888 to individual tracks and /or virtual tracks, they must also be named using the naming conventions (TRK01VT1.WAV) explained above.

If you use a computer (connected in USB mode) to rename these files, the D888 will no longer recognize them as track files, and the tracks to which those files had been assigned will be empty.

Stereo WAV files can be named freely, and can be assigned to adjacent pairs of tracks.

note By renaming the files in accordance with the automatically-assigned track file naming conventions described above, you can change the track or virtual track of the data.

MST00001.WAV (master track WAV file)

This is a stereo WAV file created each time you record the master track. The file name consists of the MST + number (the number of the recording).

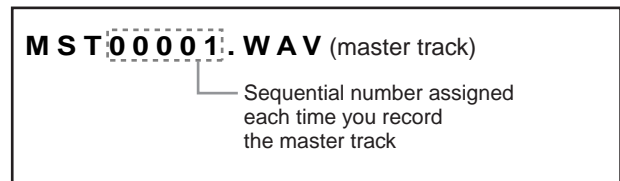

note You can create as many WAV files as the free space on the hard drive will allow, but the D888 will recognize only one hundred of them.

□□□□.WAV (WAV files)

These are 16-bit 44.1 kHz audio files. You can use them as playback data for the tracks as described in "Selecting WAV files".

WAV files that can be used on the D888

The D888 allows you to select stereo WAV files for use.

It can recognize a mono WAV file, but an error message will appear if you select it. In order to use a mono wave file, it must be named using the automatic naming conventions of the D888 (TRK01VT1.WAV, TRK01VT2.WAV, ... TRK08VT8.WAV).

note You'll be able to use a monaural WAV file if you use your computer to change the file name to the track WAV file name automatically assigned by the D888.

The D888 can display a WAV file name up to sixteen characters long, but depending on the screen this may be only eight characters. WAV files with names of seventeen characters or longer can also be recognized, but we recommend that you use short file names so that it will be easy to distinguish them on the D888's screen.

Song file details

The D888 has settings that are stored independently for each song, and settings that apply in common to all songs. Settings of the monitor LEVEL knob, headphone level knobs, and TRIM knobs are not memorized. You will need to read-just these yourself. Undo/Redo data is discarded when you shut down, select a song, or reload.

Settings common to all songs

- LEVEL METER settings (counter display, peak hold type, channel/input level meter)
- Phantom power setting
- Output assign setting
- Auto input setting
- MTC Out setting
- LCD contrast
- Foot switch polarity
- Metronome (Assign)
- Resume setting
- Last-selected song

Settings stored independently for each song

Settings that are always loaded when you select or reload a song

- Song name
- Virtual track settings
- Channel buttons (REC/PLAY, BOUNCE, CH ON)
- Master track setting
- REC/PLAY MODE setting
- Mark points
- Metronome (on/off, tempo, time signature, volume)

Settings that you can choose to omit when you select or reload a song (Resume function)

- Channel levels
- Master level
- EQ gain
- Effect send
- Pan
- Effect settings (on/off, program, parameter, effect return)

⚠ If you load these settings, the positions of the panel faders and knobs will not match the actual settings. The value of the current position will be applied when you first move that fader or knob. (The value will jump.)

Block diagram

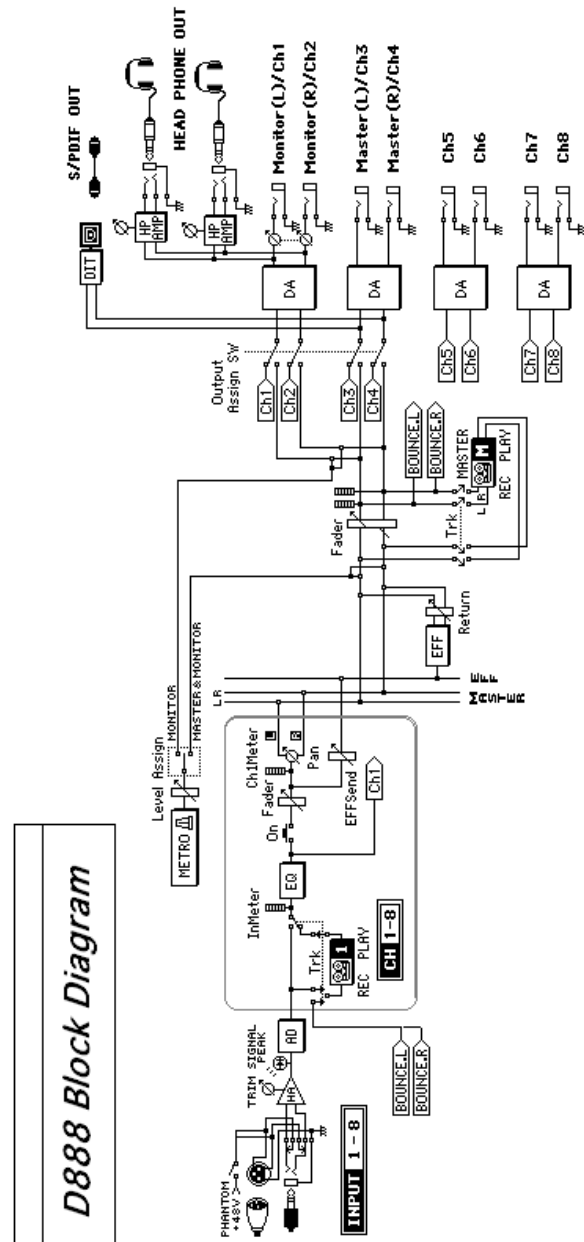

Demo Song

Song: Black Swan

Band: Uncrowned

(c)2005 Uncrowned Music, BMI

website: www.uncrowned.com

Recorded at Sonica, Atlanta GA

Edited & Assembled by Huston Singletary

www.hustonmusic.com

Specifications

Operating temperature:
+5 – +35 °C (do not allow condensation)

■ Main sections

<Recorder section>

Number of tracks: 64 + master tracks*
(including virtual tracks)*
Simultaneous playback 8 tracks,
simultaneous recording 8 tracks
* For stereo WAV files; number of tracks
will depend on the free capacity of the
hard drive

Recording format: 44.1 kHz/16-bit uncompressed

Recording time: Maximum 124 hours*
* when using a 40 GB hard drive
Maximum six hours continuous

Number of songs: Maximum 100 songs

Mark points: 100 points per song (no mark names)

USB functions: Connects to a computer via USB 2.0, and
functions as a FAT 32 USB external drive

Track editing: Copy (overwrite), erase, swap, assign WAV
files to tracks

Song editing: Copy, delete, rename, protect, save now

Metronome ♩=40–250, Time signature=0, 2, 3, 4, 6, 8

<MIDI Functionality>

MTC transmission: frame rate 30 fps, format 30 NDF

<Mixer section>

Structure: 8-channel input (8 bus), monitor x 1,
master x 1, internal effect send x 1

Signal processing 40 bit, 44.1 kHz

Equalizer: HIGH (Fc: 10 kHz, G: ±15 dB)
MID (Fc: 2.5 kHz, G: ±15 dB)
LOW (Fc: 100 Hz, G: ±15 dB)

<Effect section>

Structure: Master × 1

Signal processing 40 bit, 44.1 kHz

Programs: 11

<General>

Display: 160 × 104 pixel, movable LCD with backlight

Power supply: AC Local Voltage

Power consumption: 32 W

Dimensions: 375 mm (W) × 331 mm (D) × 110 mm (H)
15.3" (W) × 13" (D) × 4.3" (H)

Weight: 4.4 kg/9.7 lbs

■ Principal specifications

Frequency response: 10 Hz – 20 kHz +1 dB/–2 dB

S/N: 96 dB (typical) @IHF-A

THD+N: 0.03% (typical) 20 Hz–20 kHz

A/D conversion: 24-bit 64 times oversampling

D/A conversion: 24-bit 128 times oversampling

Sampling frequency: 44.1 kHz

Record/Playback bit: 16-bit

■ Analog/digital input and output specifications

Indications in square brackets [] are when output assign
is INDIVIDUAL

<INPUT 1–8>

Connectors: XLR-3-31 type (+48 V phantom power,
switchable), 1/4" TRS phone jack (balanced)

Input impedance: 4 kΩ (XLR-3-31), 10 kΩ (TRS phone jacks)

Nominal level: –60 dBu to +4 dBu @ TRIM=max. – min.

Maximum level: –48 dBu to +16 dBu @ TRIM=max. – min.

Source impedance: 600 Ω

<MONITOR OUTPUT L/R> [CH 1, 2]

Connectors: 1/4" phone jack (unbalanced)

Output impedance: 500 Ω

Nominal level: –10 dBu

Maximum level: +2 dBu

Load impedance: 10 kΩ or higher

<MASTER OUTPUT L/R> [CH 3, 4]

Connectors: 1/4" phone jack (unbalanced)

Output impedance: 500 Ω

Nominal level: –10 dBu

Maximum level: +2 dBu

Load impedance: 10 kΩ or higher

<CH 5–8> [CH 5–8]

Connectors: 1/4" phone jack (unbalanced)

Output impedance: 500 Ω

Nominal level: –10 dBu

Maximum level: +2 dBu

Load impedance: 10 kΩ or higher

<PHONES>

Connector: 1/4" stereo phone jack × 2

Output impedance: 100 Ω

Maximum level: 50 mW+50 mW @ 32 Ω

<S/P DIF OUTPUT>

Connector: optical

Format: 24-bit S/P DIF (IEC60958)

<USB>

Connector: Type B

Format: USB2.0 High-Speed device
USB Mass Storage Class

Supported OS: Window Me, Windows 2000 or later
Mac OS 9.0.4 or later

* If using the D888 with Windows 98, please
refer to the Korg website or contact your
Korg distributor.

<MIDI IN/OUT>

Connectors: DIN 5-pin

<FOOT SW>

Connector: 1/4" phone jack (use separately sold PS-1)

■ Included items

AC cable
Owner's manual

■ Options (sold separately)

PS-1 pedal switch

* Appearance and specifications of this product are
subject to change without notice. (02, 2006)

Index

A

Adjusting the volume	25
Analog input	9
Auto Input	20, 31

B

Backup	42
Block diagram	48

C

Channel output	25
Computer	41
Connect mic	9
Connection	7, 14
Contrast	40
Copy	
Song	35
Track	37
Counter	20
Cursor keys	13

D

Delete	
Song	35
Track data	40
Display	20, 44
Download	43

E

Effect	44
EQ	16, 25
Equalizer	16, 25
Erase	38
Erase Track	38
Error message	45, 46
Exchanging tracks	38

F

Files you can use	42
Foot switch	40
Formatting	41

I

Info: "****"	46
Input	9, 16, 24, 44
Input and output specifications	49
Input level	24

L

LCD	20
Level meters	20
Load system	43
Locate points	30, 37
Location	
Moving	22

M

Macintosh	42
Main power switch	6, 12
Manual punch recording	29
Mark	
Deleting	23
Moving	23
Storing	23
Mastering	18
Metronome	25, 44
MIDI	43, 45
Implementation chart	51
MIDI OUT	12, 43
Mixdown	18
Mode keys	12
Mode screen	13
Move	
FF, REW keys	22
Point	22
Muting	25

N

New song	15
----------	----

O

Operations	13
Outputting	
Audio	24
Overdubbing	17

P

PAN	16
Parameter select	13
Peak Hold	20
Playback	44
Basic	16
Channel tracks	32
Master track	32
Repeat	32
Types	32
Power	44
Off	7
On	6
Protect	20

R

Recording	44
Automatically switching	31
Basic	15
Bounce	27
Channel tracks	27
Manual punch	29
Master track	18, 28
Overdub	17, 27
Punch-in/out	29
Rehearsal	31
Repeat	30
Types	26
Redo	41
Rehearsal function	31
Repeat	20

S

S/P DIF OUT	12
Save	
Effect	34
Song	19, 36
Settings common	48
Shutdown	7
Song	
Copy	35
Delete	35
Name	21
New	15, 21
Protect	36
Reloading	35
Save	19, 36
Selecting	21
Specifications	49
Stereo position	16, 25
Structure	19
Swap track	38

T

Track	
Copy	37
Delete	40
Erase	38
Swap	38
Trouble	44

U

Undo	41
Upgrading the system	43
USB	12, 45
USB mode	42

V

Virtual tracks	26
----------------	----

W

WAV files	47
Windows	42

MIDI Implementation Chart

Function		Transmitted	Recognized	Remarks
Basic Channel	Default Changed	× ×	× ×	
Mode	Memorized Messages Altered	× × *****	× ×	
Note Number:	True Voice	× *****	×	
Velocity	Note On Note Off	× ×	× ×	
Aftertouch	Polyphonic (Key) Monophonic (Channel)	× ×	× ×	
Pitch bender		×	×	
Control Change	0 – 111	×	×	
Program Change	Variable Range	× *****	× *****	
System Exclusive		○	×	MTC full messages are transmitted if the menu's MTC Out setting is "ON".
System Common	Quarter frame Song Position Song Select Tune	○ × ×	× × × ×	Transmitted if the menu's MTC Out setting is "ON".
System Real Time	Clock Command	× ×	× ×	
Aux Messages	Local On/Off All Notes Off Active Sense Reset	× × × ×	× × × ×	
Notes				

Mode 1 : OMNI ON, POLY Mode 2 : OMNI ON, MONO : Yes ○
Mode 3 : OMNI OFF, POLY Mode 4 : OMNI OFF, MONO : No ×

Consult your local Korg distributor for more information on MIDI IMPLEMENTATION.

IMPORTANT NOTICE TO CONSUMERS

This product has been manufactured according to strict specifications and voltage requirements that are applicable in the country in which it is intended that this product should be used. If you have purchased this product via the internet, through mail order, and/or via a telephone sale, you must verify that this product is intended to be used in the country in which you reside.

WARNING: Use of this product in any country other than that for which it is intended could be dangerous and could invalidate the manufacturer's or distributor's warranty.

Please also retain your receipt as proof of purchase otherwise your product may be disqualified from the manufacturer's or distributor's warranty.

KORG KORG INC.

4015-2 Yanokuchi, Inagi-city, Tokyo 206-0812 Japan