

FIELD MEMORY RECORDER *Model* **FR-2**

Owner's Manual

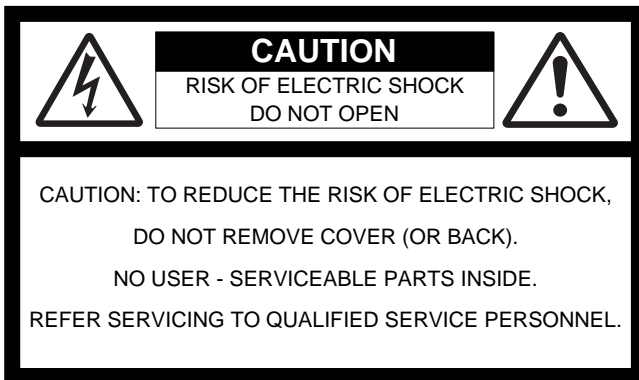



"WARNING"

"TO REDUCE THE RISK OF FIRE OR ELECTRIC SHOCK, DO NOT EXPOSE THIS APPLIANCE TO RAIN OR MOISTURE."

SAFETY INSTRUCTIONS

1. Read Instructions - All the safety and operating instructions should be read before the appliance is operated.
 2. Retain Instructions - The safety and operating instructions should be retained for future reference.
 3. Heed Warnings - All warnings on the appliance and in the operating instructions should be adhered to.
 4. Follow Instructions - All operating and use instructions should be followed.
 5. Water and Moisture - The appliance should not be used near water - for example, near a bathtub, washbowl, kitchen sink, laundry tub, in a wet basement, or near a swimming pool, and the like.
 6. Carts and Stands - The appliance should be used only with a cart or stand that is recommended by the manufacturer.
-
- An appliance and cart combination should be moved with care. Quick stops, excessive force, and uneven surfaces may cause the appliance and cart combination to overturn.
7. Wall or Ceiling Mounting - The appliance should be mounted to a wall or ceiling only as recommended by the manufacturer.
 8. Ventilation - The appliance should be situated so that its location or position does not interfere with its proper ventilation. For example, the appliance should not be situated on a bed, sofa, rug, or similar surface that may block the ventilation openings; or, placed in a built-in installation, such as a bookcase or cabinet that may impede the flow of air through the ventilation openings.
 9. Heat - The appliance should be situated away from heat sources such as radiators, heat registers, stoves, or other appliances (including amplifiers) that produce heat.

CAUTION:

TO PREVENT ELECTRIC SHOCK, MATCH WIDE BLADE OF PLUG TO WIDE SLOT, FULLY INSERT.

ATTENTION:

POUR ÉVITER LES CHOCS ÉLECTRIQUES, INTRODUIRE LA LAME LA PLUS LARGE DE LA FICHE DANS LA BORNE CORRESPONDANTE DE LA PRISE ET POUSSER JUSQU' AU FOND.



The lightning flash with arrowhead symbol, within an equilateral triangle, is intended to alert the user to the presence of uninsulated "dangerous voltage" within the product's enclosure that may be of sufficient magnitude to constitute a risk of electric shock to persons.



The exclamation point within an equilateral triangle is intended to alert the user to the presence of important operating and maintenance (servicing) instructions in the literature accompanying the appliance.

10. Power Sources - The appliance should be connected to a power supply only of the type described in the operating instructions or as marked on the appliance.
11. Grounding or Polarization - The precautions that should be taken so that the grounding or polarization means of an appliance is not defeated.
12. Power Cord Protection - Power supply cords should be routed so that they are not likely to be walked on or pinched by items placed upon or against them, paying particular attention to cords at plugs, convenience receptacles, and the point where they exit from the appliance.
13. Cleaning - The appliance should be cleaned only as recommended by the manufacturer.
14. Nonuse Periods - The power cord of the appliance should be unplugged from the outlet when left unused for a long period of time.
15. Object and Liquid Entry - Care should be taken so that objects do not fall and liquids are not spilled into the enclosure through openings.
16. Damage Requiring Service - The appliance should be serviced by qualified service personnel when:
 - A. The power supply cord or the plug has been damaged; or
 - B. Objects have fallen, or liquid has been spilled into the appliance; or
 - C. The appliance has been exposed to rain; or
 - D. The appliance does not appear to operate normally or exhibits a marked change in performance; or
 - E. The appliance has been dropped, or the enclosure damaged.
17. Servicing - The user should not attempt to service the appliance beyond that described in the operating instructions. All other servicing should be referred to qualified service personnel.
18. The appliance should be situated away from drops of water or spray of water.
19. Objects containing liquid such as vase must not be put on the appliance.
20. The appliance is not completely isolated from the power supply even if the power switch is at off position.

Table of contents

About this manual7
Precautions7
Precautions on installation8
Brief guide to this manual9
 Manual organization9
 Manual conventions10

Chapter 1: Product overview13

Overview14
Main features14
What is in the box15
FR-2 options and related Fostex products15

Chapter 2: Before using the FR-217

About power supply18
 Operating on batteries18
 Inserting batteries18
 Reducing battery power consumption19
 Operating on AC adaptor20
 Connecting the AC adaptor20
 Turning on the power20
 About power supply voltage21
Setting the display backlight/contrast22
 Turning the backlight on or off22
 Adjusting the display contrast22
About the realtime clock23
About memory cards24
 Inserting/removing a memory card24
 Inserting a card25
 Removing a card27
Initial format of a memory card29

Chapter 3: Names and functions31

Front panel32
Top panel34
Left side panel37
Right side panel37
Bottom panel38
Details about screen39
 Home screen39
 When no memory card is set in the slot39

When a virgin memory card is set in the slot	40
When a recorded memory card is set in the slot	40
MENU mode screens	40
Warning messages	41

Chapter 4: Basic connections43

Audio input/output connection	44
Analog audio input connection	44
Digital audio input connection	45
Analog audio output connection	45
Digital audio output connection	45
PC/Keyboard connection	46
Connecting the FR-2 to a PC	46
Connecting the FR-2 to a USB keyboard	46

Chapter 5: Recording / playback47

About recording system	48
Recording analog audio	49
Selecting the input source	49
Adjusting the input gain	49
Filter setting	49
Limiter setting	50
Selecting the sampling frequency/quantization bit length	50
Selecting the track mode	51
Adjusting the recording level	51
Monitoring recording signals	52
Checking the remain for recording	52
Making recording	53
Recording with PRE REC active	54
About overloading	54
Recording digital audio	55
Selecting the track mode	55
Selecting the sampling frequency /bit length	55
Setting cue points	56
Setting a cue point on-the-fly	56
Viewing cue point information	57
Deleting a cue point in realtime	57
Playback	58
Normal audio playback	58
Cueing playback	58
Skip / locate functions	59
Skipping by file	59
Skipping by cue point	59
Locating to the beginning (ABS 0) of a file	59
Locating to the end (REC END) of a file	59
Locating to the desired cue point	59

Chapter 6: MENU mode	61
Menu mode outline	62
Cue menu	63
Locating to a cue point (Locate)	63
Renaming a cue point (Rename)	64
Editing time data of a cue point (Edit)	66
Deleting a cue point (Delete)	67
File menu	68
Selecting an audio file to be played back (Select)	68
Renaming an audio file (Rename)	69
Deleting an audio file (Delete)	70
Audio file protection on/off (Protect)	72
Restoring an audio file (Restore)	73
Disk menu	72
Selecting the current drive (Select)	72
Optimizing a memory card (Optimize)	75
Formatting a memory card (Format)	76
Editing a volume label of a memory card (Volume Label)	77
Viewing information of a memory card (Disk Info.)	79
Setup menu	80
Selecting default file name type (File Name Mode)	81
Setting the default file name (Default File Name)	82
Adjusting the real time clock (Adjust Real Time)	85
Speaker mute function on/off (Speaker Mute)	86
Setting error tone output condition (Error Tone)	87
Setting the peak hold time of the level meters (Peak Hold Time)	88
Setting the time length stored in the buffer for Pre rec mode (Pre Rec Time)	89
Selecting the remain display mode (Remain Display)	90
Setting the digital output signal format (Digi Out Type)	91
Selecting the battery type (Battery)	92
Selecting the USB keyboard type (Keyboard)	93
Checking the ROM version (Version)	94
Initializing settings of the Setup menu (Init Setup)	95
Chapter 7: Exporting audio files to a PC	97
Connecting the FR-2 to a PC	98
Connecting the FR-2 to a PC	99
Exporting audio data to a computer application (example)	100
Chapter 8: Main specifications	103
Inputs/Outputs	104
Recording/Playback	105
General	105
Physical dimensions	106

About this manual

This manual covers all about how to use the Fostex FR-2 Field Memory Recorder.

Its explanations assume that you have basic knowledge and experience of professional digital recording.

To understand the FR-2 features and learn how to use the FR-2 quickly and roughly, we recommend reading "Chapter 1: Introduction" and "Chapter 3: Names and Functions".

Chapter 2 ("Before using the FR-2) describes important basics about power supply and memory cards. We recommend to read this chapter before using the FR-2 first time.

Precautions

- When supplying the power to the unit from the AC power outlet, only use the Fostex Model AD12-1300 AC adaptor (note that the AD12-1300 is an option).
If you use any other AC adaptor, the unit may not work correctly and there is a serious risk of damage to the unit.
- Make sure that the voltage of your AC power outlet matches the voltage requirements printed on the AC adaptor.
If you wish to use the unit in a country where the voltage of the AC power outlet does not match your AC adaptor, ask your local Fostex dealer or service station for purchasing an appropriate AC adaptor. Note that the AC adaptor can be used both in 50 Hz and 60 Hz areas.
- When operating the unit on batteries, use alkaline, Ni-Cd, or Ni-MH batteries. Rechargeable batteries should be fully charged.
- When removing batteries or disconnecting the AC adaptor, make sure that the unit [POWER] switch is set to "OFF".
Removing batteries or disconnecting the AC adaptor while the power is "ON" may damage data because the unit always transfers data between the current card and memory.
- While the unit is accessing a memory card (for example, during recording), never turn off the power. Make sure that the unit completely stops accessing the card before you turn off the power. Otherwise, recorded data may be lost, as well as the memory card may be damaged.
Note that Fostex assumes no responsibility on data loss or whatsoever due to use of the unit.
- Fostex is not responsible for any "direct damage" or "indirect damage" caused by using the unit.

- Do not let water or other liquid, or metal objects such as pins, accidentally enter the inside of the unit (especially inside of the card slots) because this may lead to electric shock or damage. Should water enter the inside of the unit, turn off the power, unplug the AC adaptor and remove batteries, and consult your dealer or the nearest FOSTEX service station.
- Do not drop the unit or give it a strong shock. The internal circuits, display, panels may be damaged. Although the unit is designed to operate outside, handle the unit with great care because it is a precision machine.
- To prevent possible electric shock and damage to the unit, do not remove the cover or reach the inside of the unit.
- When using the supplied carrying belt, to prevent the unit from dropping accidentally, make sure that it is attached to the unit correctly.
- Do not give a strong shock to the LCD display. The liquid used inside the LCD display is toxic. If the liquid is spilled, do not suck it in. If it is stained to your hand or skin, wash immediately with plenty of water.

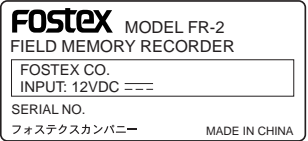
<p><Important> The model name, power requirement and serial number of the unit are labeled on the bottom panel.</p>	
--	---

Precautions on installation

- **Do not install the unit in the following conditions.**
 - in a extremely hot or cold place
 - in a moist place
 - in a shaky or unstable place
 - in a dusty place
 - in a strong magnetic field or near a device which generates a magnetic field
 - in the direct sunshine
 - in the direct rain or water
- **Notes on moisture condensation**
When you bring the unit from a cold place to a warm place, moisture may condense on the drive, display, panels, etc. In such a case, leave the unit for a while until it warms up and evaporates any moisture.

Brief guide to this manual

This manual is intended to be used as a guidebook for using the Fostex FR-2 Field Memory Recorder.

The manual is divided into Chapters. Each Chapter covers instructions for a specific subject or feature of the FR-2 which you should know for using the unit, as well as safety instructions, precautions, etc. Please retain this manual at hand so that you can read it whenever necessary.

<Manual organization>

The following shows a brief introduction of each chapter, though you may know the contents of each chapter from the "Table of Contents".

Chapter 1: Product overview

This chapter describes the brief introduction of the FR-2, as well as main features.

Chapter 2: Before using the FR-2

This chapter describes some notes on the power supply, as well as memory cards including the initial format.
Read this chapter before using the FR-2 for the first time.

Chapter 3: Names of Functions

This chapter describes names and functions of keys and controls on the front and top panels, as well as those of connectors on the left and right side panels.

If you are familiar with digital equipment, you may roughly understand the FR-2 functions
by looking through this chapter.

Chapter 4: Basic connection

This chapter describes basic connection between the FR-2 and external devices. It includes details about how to connect analog and digital audio signals, as well as how to connect a PC and a USB keyboard to the unit via USB connectors.

Chapter 5: Recording/playback

This chapter describes analog and digital audio recording/playback using the FR-2.

Descriptions for storing cue points, as well as the skip and locate functions, are also included.

Chapter 6: MENU mode

This chapter describes details about each menu items on each menu in the MENU mode.

Five menus are available in the MENU mode. Each menu includes various menu items as shown below. (Note that menu items may change when the FR-2 is upgraded.)

1) Cue menu (including menu items regarding cue points)

Locate	Used to locate to a desired cue point directly.
Rename	Used to rename a cue point.
Edit	Used to edit a cue point.
Delete	Used to delete a cue point.

2) File menu (including menu items regarding audio files)

Select	Used to select a file for playback.
Rename	Used to rename a file.
Delete	Used to delete a file.
Protect	Used to select file protection on/off setting.
Restore	Used to restore a deleted file.

3) Disk menu (including menu items regarding a memory card)

Select	Used to select the current drive.
Optimize	Used to optimize a memory card.
Format	Used to format a memory card.
Volume Label	Used to edit a volume label of a memory card.
Disk Info.	Shows the current memory card information.

4) Setup menu (including menu items for FR-2 preferences, etc.)

File Name Mode	Used to select the file name mode.
Default Scene Name	Used to set the default scene name and take number for a file name.
Adjust Real Time Clock	Used to adjust the real time clock.
Speaker Mute	Used to select speaker mute function on/off setting.
Error Tone	Used to set the error tone output condition.
Peak Hold Time	Used to set the peak hold time of the level meters.
Pre Rec Time	Used to set the time length of audio stored in the buffer when the Pre rec mode is set to ON.
Remain Display	Used to select the remaining display readout.
Digi Out Type	Used to select the digital output signal format.
Battery	Used to select the battery type.
Keyboard	Used to select the USB keyboard type.
Version	Shows the current ROM version.
Init Setup	Used to initialize all Setup menu item settings to the default (when the unit is shipped).

5) USB mode menu (enables PC connection for file transfer)

Chapter 7: Exporting audio files to a PC

This chapter describes how to copy recorded audio file data (WAV file) to a PC hard disk and how to export data to a computer application software such as the Digidesign Pro Tools.

Chapter 8: Specifications

This chapter describes mechanical and electrical specifications of the FR-2.

Manual conventions

This manual is described according to the following conventions.

1. **The following abbreviations are sometimes used.**

<Examples>

CompactFlash card	->	CFC
Flash ATA Card	->	ATA
Sampling frequency	->	FS
Realtime clock	->	RTC
Personal computer	->	PC

2. **The names of keys, switches and connectors of the FR-2 used in this manual match their labels on the panel.**

<Examples>

Playback key	->	the [PLAY] key
Sampling frequency select switch	->	the [FS (kHz)] switch
Analog input connectors	->	the [ANALOG IN] connectors

3. **The on-screen messages and switch position names are surrounded by " ".**
4. **The on-screen messages and items, as well as the indicators on the panel, "light" or "flash".**
5. **"Notes" give a tip or advice for using the FR-2 powerfully and skillfully.**

Memo

Chapter 1: Product overview

This chapter describes the product overview as well as main features/functions, etc.

Overview

The Model FR-2 is a portable two-track field memory recorder for professional use, which records to CompactFlash cards or Flash ATA cards. You can make high quality recording either in stereo or mono.

Designed specifically for location recording, the FR-2 is a portable and light-weighted machine, offering simple and easy-to-use operation. You can operate the FR-2 on batteries or on the optional AC adaptor.

The FR-2 provides two types of USB ports, allowing PC and USB keyboard connection. By making PC connection, you can easily transfer audio files from the FR-2 to a PC and edit the files on it.

Main features

- Two card slots are provided; one for TYPE II CompactFlash cards, the other for Flash ATA cards. You can use either of these slots according to the card used.
- Two ways to supply the power to the unit; batteries (alkaline, Ni-Cd, or Ni-HM batteries) and the optional AC adaptor (Model AD12-1300).
- Supports the FAT32 file system. The Broadcast Wave File (BWF) recording file format (interleave 1 file mode) is used, which enables exporting files to a DAW such as Pro Tools.
- Supports a variety of sampling frequencies/quantization bits. 24-bit at 44.1 kHz, 48 kHz, 88.2 kHz, 96 kHz, 176.4 kHz and 192 kHz. 16-bit at 22.056 kHz, 44.1 kHz and 48 kHz.
- The "Pre Record" function, a useful feature for location recording, enables FR-2 to constantly store up to approximately 20 seconds of audio to the internal buffer. When you start recording, the previous data is first delivered from the buffer (you can edit the time length of audio stored in the buffer using the Setup menu in the MENU mode).
- Provides the input selector, trim control, high-pass filter and limiter for each of left and right channels independently.
- 128 x 64 highly visible, low power consumption, backlit dot matrix LCD display shows various information.
- USB port for PC connection. By connecting a PC directly, you can transfer audio files (WAV files) between the FR-2 and the PC.
- USB port for keyboard connection. By connecting a USB keyboard, you can make some of setting or editing operations from the keyboard, instead of operations using the FR-2 panel keys. (Note that operations which you can make from a keyboard are limited.)
- You can set a marker (cue point) at a desired point during recording (up to 99 cue points can be set per file). You can locate or skip to a desired cue point quickly.

- The reference input level is fixed to -20 dB. The headroom margin of the line input is +24 dB, while that of the mic input is +40 dB.
- By installing the optional TC/SYNC card (available soon), you can stripe the IEC timecode.
- The error tone can be generated to warn you when the analog input amplifier clips due to over level, when the battery voltage drops down to the specific level, or when the remaining recording time of the memory card gets short (you have to set the associated menu item appropriately).

What is in the box

Make sure that the box contains the following. If any of them are missing, please contact your Fostex dealer.

FR-2	1
Carring belt	1
Operation manual (this manual)	1

<Note>

No power supply (batteries or the AC adaptor) for operating the FR-2 is supplied. To operate the unit on batteries, use alkaline, Ni-Cd, or Ni-MH batteries . To operate the unit on AC adaptor, use the optional Fostex AC adaptor (Model AD12-1300).

FR-2 options and related Fostex products

The following FR-2 options and related products are available. Apply to your local Fostex dealer or sale office for further details (prices, specifications, etc). you can also get information from the Fostex web site by accessing to the following URL.

<http://www.fostex.co.jp>

Options

- External power supply unit (AC adaptor): AD12-1300

The following related products are also available from Fostex.

Related products

- DVD digital master recorder: DV40
- DVD location recorder: PD-6
- DAT digital master recorder: D-15
- Personal powered monitor: 6301B/BX
- Stereo headphones: T20RP MkII/T-5/T-7/T40RP MkII/T50RP

Memo

Chapter 2: Before using the FR-2

<Please read this chapter before using.>

This chapter describes details about power supply for operating the unit and memory cards for recording. Please read this chapter thoroughly before using the unit so that you can supply the power to the unit properly, as well as make recording smoothly. Especially, never miss to read the description of how to format a memory card.

<Table of contents>

About power supply	18
Operating on batteries	18
Inserting batteries	18
Reducing battery power consumption	19
Operating on AC adaptor	20
Connecting the AC adaptor	20
Turning on the power	20
About power supply voltage	21
Setting the display backlight/contrast	22
Turning the backlight on or off	22
Adjusting the display contrast	22
About the realtime clock	23
About memory cards	24
Inserting/removing a memory card	24
Inserting a memory card	25
Removing a memory card	27
Initial format of a memory card	28

About power supply

The FR-2 is powered either by eight AA-type batteries (alkaline, Ni-HM or Ni-Cd) or by the AC adaptor (Fostex Model AD12-1300, optional).

Ask your local Fostex dealer or sales office for purchasing the optional AC adaptor.

<Note>: Make sure that the FR-2 power switch is set to "OFF" when changing batteries or when disconnect the AC adaptor from the unit. The unit continuously accesses data when the power is on, so the memory contents may be reset by the sudden power interruption.

Operating on batteries

Batteries are not supplied with the FR-2, therefore, if you wish to operate the FR-2 on batteries, purchase appropriate batteries.

<Notes on using batteries>

- * Use alkaline, Ni-Cd, or Ni-HM batteries. Do not use manganese batteries.
- * Use new batteries (or fully charged batteries) when replacing batteries.
- * Do not mix old and new batteries together.
- * Use the same type of batteries in the FR-2 at one time.
- * Do not use leaked batteries.

<Notes on using rechargeable Ni-Cd/Ni-HM batteries>

- * The FR-2 does not provide battery charging facility. To charge rechargeable Ni-Cd or Ni-HM batteries, use an appropriate battery charger for the battery type and follow the instructions of the charger to fully charge batteries.

• Inserting batteries

<Important! (Do not forget to make the following setting.)>
After inserting (or replacing) batteries and turning on the FR-2, be sure to select the battery type (Ni-HM, Ni-Cd or Alkaline) to match the batteries inserted using the "Battery Type" menu item on the Setup menu in the MENU mode. If the batteries in the battery compartment do not match the battery type setting, the error tone function, etc. may not work correctly because of the voltage difference.
See page 87 for details about how to set the battery type.

- 1) **Remove the compartment cover on the bottom panel of the FR-2.**
Use a coin, etc. to loosen the screw and remove the compartment cover.

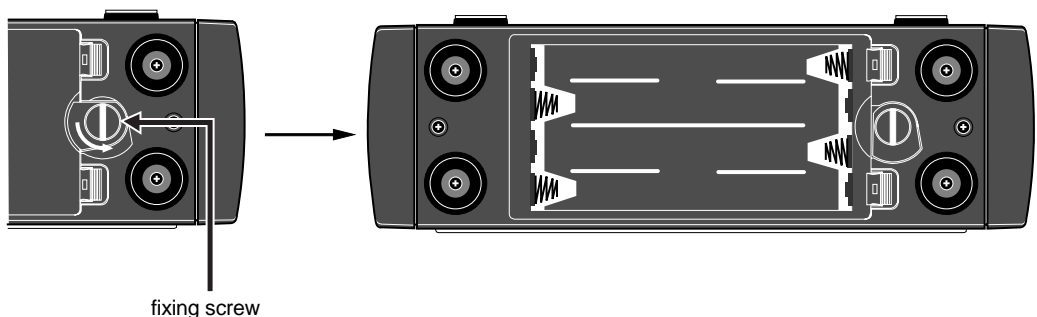

2) **Insert eight AA-type batteries.**

Make sure that the batteries are the right way round (+ and -), as shown below.

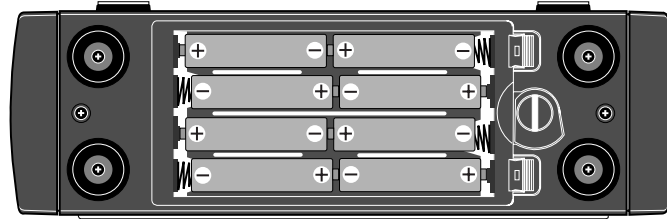

<Warning!> Wipe terminals of the battery compartment and batteries with a dry cloth on occasion. If terminals are dirty, the voltage supplied to the unit may drop down.

3) **Fit the compartment cover as it was before.**

Be sure to fasten the screw tightly so that the compartment cover never drops while using the FR-2.

<Warning!> Used batteries should be disposed following to your local regulations to avoid problems of environmental pollution.

The chart below shows the expected battery life of continuous operation by type. Note that it depends on the circumstance the FR-2 is used (temperature, humidity, the number of recordings) and battery manufacturers, therefore, use the chart just for your reference.

The FR-2 can indicate remaining battery life, as well as can generate the error tone when the power voltage drops down to the specific level. When you use batteries for operating the FR-2, you should also read "About power voltage" described on page 21.

Ni-HM	Alkaline
approx. 2 hours 30 minutes (using 2300 mAh)	approx. 1 hours 20 minutes (using 2300 mAh)

• **Reducing the battery power consumption**

For reducing battery power consumption to extend the battery life, when the internal monitor speaker is disengaged (i.e. when a headphones plug is inserted to the [PHONES] jack), no power is supplied to the internal amplifier which is used for driving the internal speaker.

You can also reduce power consumption by the following tips.

- The lower the input impedance of a device connected to the FR-2's output connectors, the less battery power the FR-2 consumes.
- The lower the output level of headphones or internal monitor speaker, the less power consumption.
- If you do not use the FR-2 for a long period of time, you should remove batteries (when batteries are inserted, the FR-2 consumes little power even though the [POWER] switch is set to "OFF").

Operating the FR-2 on the AC adaptor

To operate the FR-2 on an AC adaptor, use the optional Fostex AD12-1300 AC adaptor.

<Notes>: Use only the AD12-1300 for an AC adaptor. Using another AC adaptor may damage the FR-2 due to the mismatch of the power voltage, polarity, etc. When connect or disconnect the AC adaptor, make sure that the [POWER] switch is set to "OFF".

• Connecting the AC adaptor

While the [POWER] switch of the FR-2 is set to "OFF", connect the AC adaptor to the [DC IN] jack on the left side panel of the FR-2, and then to the AC main outlet.

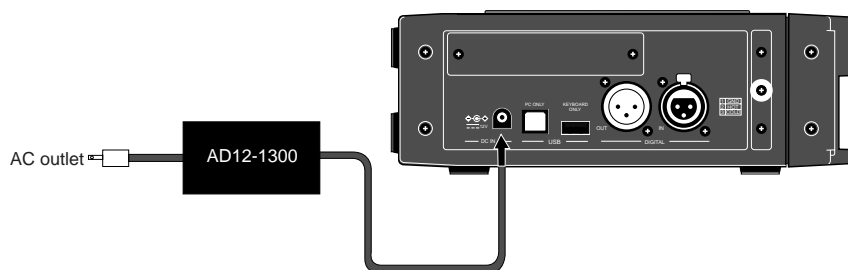

<Note>: Do not unplug the AC adaptor while the FR-2 is accessing a memory card (i.e. during recording, playback, etc.). By turning off the power, recorded or dacording data may be lost, as well as the memory card may be damaged.

Turning on the power

By setting the [POWER] switch to "ON" after inserting batteries or connecting the AC adaptor, the FR-2 starts up. If you turn on the power while no memory card is inserted, the screen as shown below appears on the LCD display. This screen is called "Home screen". See "Home screen" on page 39 for details.

<Note>: The [POWER] switch is of the "momentary type", therefore, when turning off the power, you move it to the same direction as when turning on the power. To protect a memory card and data, the FR-2 is designed to disable the [POWER] switch during re-cording or playback so that you cannot turn off the power.

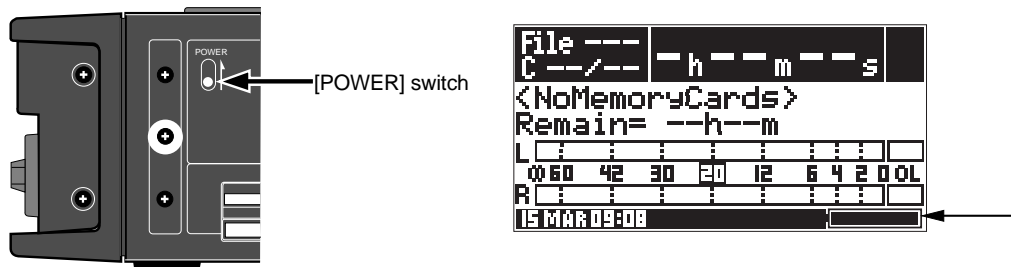

When the FR-2 normally starts up, the "BATT" indicator at the lower right of the screen (pointed by the arrow above) fully lights up. This indicates the sufficient power is supplied to the unit.

While operating the FR-2 on the AC adaptor, the indicator always fully lights up. While operating the FR-2 on batteries, the length of the "BATT" indicator changes according to the battery condition (the lower battery power voltage, the shorter "BATT" indicator). Pay attention to the indicator when you operate the FR-2 on batteries, and replace batteries at the appropriate timing. See the next page for details about power voltage.

You can turn on the backlight of the display, as well as adjusting the display contrast. See "Setting the display backlight/contrast" on page 22 for details.

About power supply voltage

When the FR-2 operates on batteries, you can check the battery condition via the "BATT" indicator.

When the battery voltage gets lower, the lighting area of the "BATT" indicator becomes shorter. The battery life depends on batteries, however, you can roughly know the current battery condition via the indicator (when operating the unit on the AC adaptor, the indicator always fully lights).



<Notes> If you continue to use the FR-2 after the "BATT" indicator gets shorter and batteries are exhausted, the display shows the warning message as shown right, and the FR-2 automatically shuts down. When operating the FR-2 on batteries, you should always pay attention to the battery power condition.

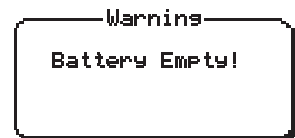

In addition to the "BATT" indicator, the FR-2 provides the error tone function which warns you when the battery power drops down.

This function generates the error tone from the internal monitor speaker (or from headphone output) when the battery power voltage drops down to the specific level. You can make the error tone output setting from the "Error Tone" menu item on the "Setup" menu in the "MENU mode". See "Setting error tone output condition" on page 87.

<Notes>

- Supplying excessive voltage may damage the unit. Never supply voltage which exceeds the regular voltage.
- If batteries are completely exhausted or the power supply section has a trouble by surge current, etc., the protection circuit works and the power is shut off. In such a case, set the [POWER] switch to "OFF", replace batteries with new (or fully-charged) ones, then set the [POWER] switch to "ON" again.
If the FR-2 does not return to the normal condition after carrying out the procedure above, there may be some trouble inside the circuit. In such a case, consult your local Fostex dealer or service station.
- Never turns off the power when the [ACCESS] indicator flashes. Data currently being recorded or played back may be damaged.

Setting the display backlight/contrast

According to the situation, you can turn the display backlight on or off, as well as adjust the display contrast.

Turning the backlight on or off

By pressing the [LIGHT] key on the front panel, the display backlight turns on for three seconds and then automatically turns off.

By pressing and holding the [LIGHT] key for more than two second, the backlight turns on and keeps lighting. To turn off the backlight, press the [LIGHT] key again.

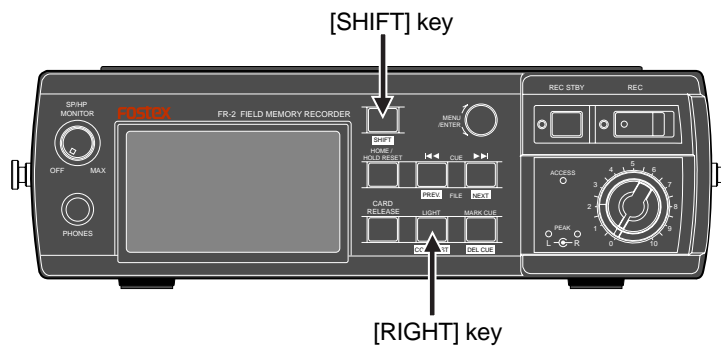

<Note>: When operating the unit on batteries, to save the battery power, we recommend not keeping the backlight lighting unless it is necessary.

Adjusting the display contrast

While the unit is stopped, you can adjust the display contrast by following the procedure below.

- 1) **When the FR-2 is stopped, press the [LIGHT] key while holding down the [SHIFT] key.**
The current contrast value is shown at the position where the current file name is usually shown (pointed by the arrow below).

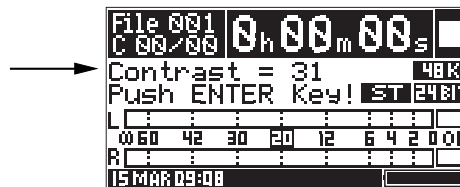

- 2) **Rotate the [MENU] dial to adjust the display contrast (adjustable level: 0 to 63).**
Rotating the [MENU] dial changes the contrast in realtime.
The lower the contrast value, the lower the contrast is.
The higher the value, the higher the contrast is.
- 3) **Press the [ENTER] key to fix the contrast value.**
The display returns to show the previous Home screen, while the selected contrast value is stored to the Flash ROM. If you do not press the [ENTER] key for five seconds after adjusting the contrast, the display returns to show the Home screen and the contrast value is stored automatically.

Setting the realtime clock

The FR-2 offers the realtime clock and the time data is shown on the display .
 Realtime clock data itself can be used as a file name when a new audio file is created on the card (i.e. the file name shows the creation date/time of the file).



<Notes>: By default, the realtime clock is adjusted to the local time of the factory when shipped. Therefore, set the time to your local time before using the unit.
 You can adjust the realtime clock from the "Adjust Real Time Clock" menu item on the "Setup" menu in the MENU mode. See "Adjusting the real time clock" on page 85 for details.

<Notes>: By default, when an audio file is created, the realtime clock data is automatically used as the file name (we call it "default file name"). The file name is shown on the display as in the example below (pointed by the arrow).
 You can select the default file name between "realtime clock data" and "scene name + take number" from the "File Name Mode" menu item on the "Setup" menu in the MENU mode. Also, when the "scene name + take number" option is selected in this menu item, you can set the desired scene name and take number using the "Default File Name" menu item on the "Setup" menu in the MENU mode.

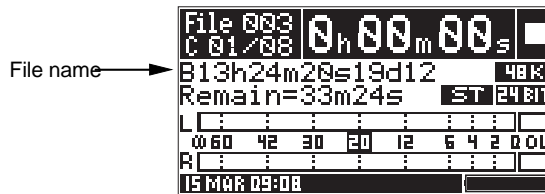

* See "Selecting default file name type" and "Setting the default scene name" on pages 81 and 82.

<Note>: The FR-2 is equipped with a lithium battery which operates the realtime clock. Normally, the battery life is approximately four or five years. When battery voltage drops down to the specific level, the following warning message appears (the warning message can be dismissed by pressing the [ENTER] key).
 If this warning message appears, ask your local Fostex dealer or service station for replacing the lithium battery (the battery cannot be replaced by a user).

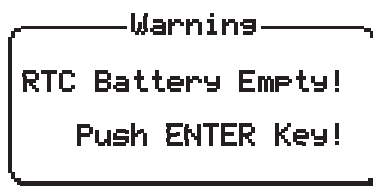

About memory card

The FR-2 records audio data to a memory card such as a CompactFlash card ("CFC" for short) and Flash ATA Card (ATA, for short) which are formatted with the FAT32 file system.

<Note>: A virgin memory card which is FAT32 formatted can be used without the need of initial-formatting, however, we recommend to format such a card using the "Format" menu item on the "DISK" menu in the MENU mode. Also, if you use a FAT32 formatted memory card which has been used with a PC, we recommend to format it in the same manner. See "Formatting a memory card" on page 76 for details about the "Format" menu item.

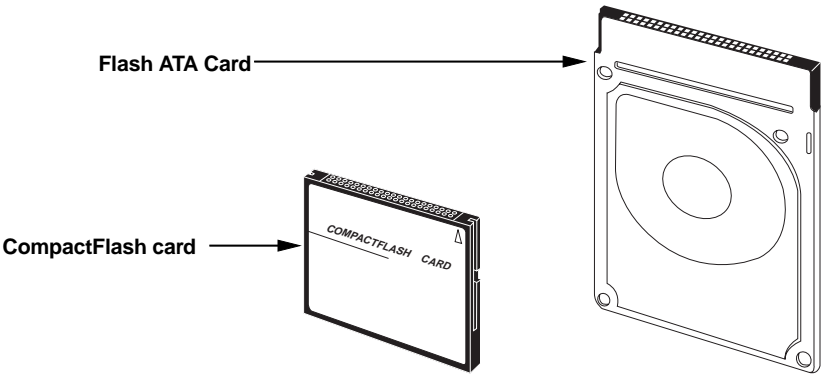

Inserting/removing a memory card

A memory card should be inserted to the appropriate card slot on the side panel of the unit. A CFC should be inserted to slot (1), while an ATA should be inserted to slot (2) in the figure below.

<Note>: You can remove or insert a card regardless of whether the power is on or off, however, never remove a card while the FR-2 is writing data to the card or reading data from the card. When you remove or insert a card when the power is on, follow the appropriate procedures described from the next page. Also be sure to insert a card in the correct direction and side. Note that Fostex is not responsible for any damage of a card caused by incorrect card handling. Note that Fostex is not responsible for any damage of a card caused by incorrect card handling.

• **Fostex is not responsible for any "direct damage" or "indirect damage" caused by using the unit.**

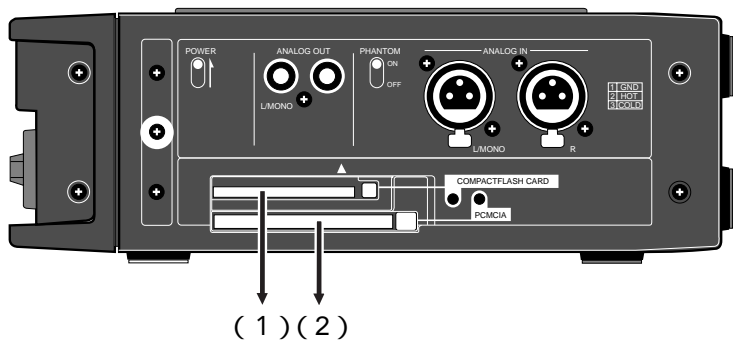

• Inserting a card

The following description assumes that no memory card is inserted to the unit and the power is turned on. "NoMemoryCards" is shown on the display.

In the following procedure example, let's assume we are going to use a virgin CompactFlash card which is FAT32 formatted.

1) Insert a memory card to card slot (1).

When inserting a memory card to the slot, the display shows the screen for asking you whether loading the card or not. (If you insert an ATA to slot (2), "Loading: PCMCIA?" is shown.)

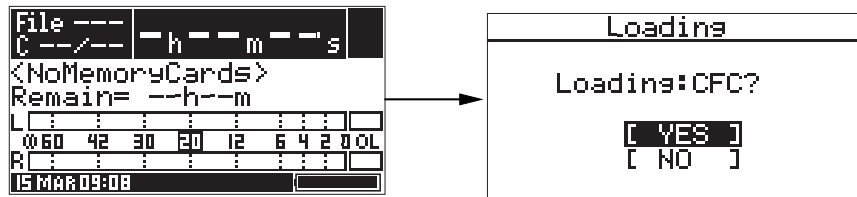

2) While "YES" is highlighted, press the [ENTER] key.

The FR-2 starts loading the card.

When loading is completed, "<No Files>" is shown on the display, together with the remaining time (or space) of the card. This shows that no audio file exists on the card. When making recording, an audio file is automatically created on the card. For details, see "Chapter 5: Recording/playback" from 47 pages.

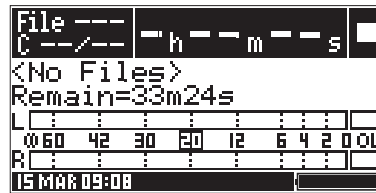

If you load a memory card on which any audio files created by the FR-2 are stored, the first file in the entry list ("File001") automatically is selected and the recorder locates the beginning of that file, while the display shows the Home screen of the file.

*** When loading a used FAT32 formatted card**

When loading a card which has been used with a PC, etc., the display also shows "<No Files>", as the screen example above. If any data is recorded on the card, the remaining space which can be used for recording by the FR-2 may be smaller. Therefore, we recommend to format the card using the "Format" menu item on the "Disk" menu in the MENU mode. See "Formatting a memory card" on page 76 for details.

*** When loading a card which is not FAT32 formatted**

When loading a card which is not FAT32 formatted, the display shows a warning message ("Illegal Format!"). You need to format the card according to the procedure described in "Initial format of a memory card" on the next page.

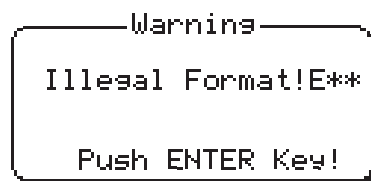

*** How to switch the current card when inserting a card to the other slot**

While a card is inserted in either of the card slots, you can insert another card to the unused card slot and switch the current card.

Assuming that a CFC is currently loaded, the procedure below shows how to switch the current card from "CFC" to "PCMCIA" after inserting an ATA.

1) While the recorder is stopped, insert an ATA to the PCMCIA slot.

The screen as shown below appears, asking whether loading the inserted ATA or not.

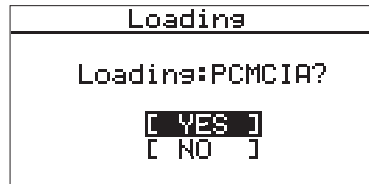

2) While "[YES]" is highlighted, press the [ENTER] key.

Pressing the [ENTER] key releases the current card (CFC, in this case) and starts loading the newly inserted card (ATA, in this case).

This operation automatically switches the setting of the "Select" menu item (on the "Disk" menu in the MENU mode) from "CFC" to "PCMCIA".

While memory cards of both types are inserted to the appropriate slots and the unit is turned on, you can select the current card using the "Select" menu item on the "Disk" menu in the MENU mode. See "Selecting the current memory card" on page 74 for details.

<Notes on the current card>

- If a card is inserted in either one of the card slots when turning on the unit, the unit automatically recognizes the inserted card as the current card, and appropriately set the "Select" menu item on the "Disk" menu in the MENU mode. For example, if you insert only an ATA and turn on the unit while the "Select" item is initially set to "CFC", the "Select" setting is automatically switched to "PCMCIA".
- If both CFC and ATA are inserted in the appropriate card slots when turning on the unit, the current card is selected according to the "Select" setting (by default, it is set to "CFC"). For example, if both CFC and ATA are inserted in the appropriate card slots and the "Select" item is set to "PCMCIA" when turning on the unit, the ATA is automatically loaded as the current card.

• Removing a card

The following describes how to remove a memory card from the slot, assuming that a CFC is inserted to the appropriate slot.

- 1) **While the recorder is stopped, press the [CARD RELEASE] key.**
 Pressing the [CARD RELEASE] key brings up the screen as shown below. This screen shows that a CFC is inserted and mounted, while no ATA is inserted, and is asking whether releasing the CFC or not.

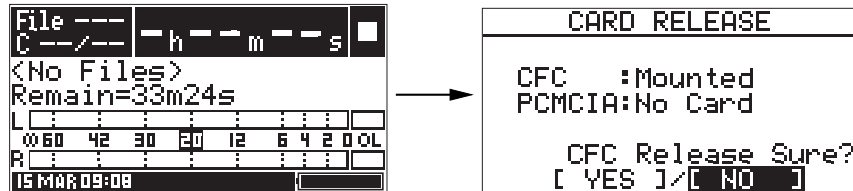
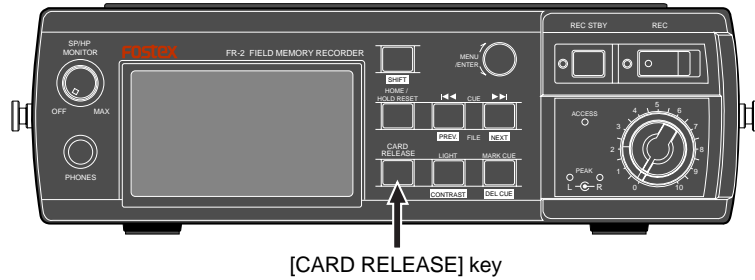

- 2) **Use the [MENU] dial to select "[YES]" and press the [ENTER] key.**
 The display shows "Please Wait!", followed by "CARDS Release OK!". When the card is completely released, the CFC indicator lights.



"Mounted" and "No Card" shown on screens above mean as below.

“ Mounted ”	The power is delivered to the card drive (the indicator is unlit). You cannot eject the card until the card is released.
“ No Card ”	No card is inserted to the slot.

- 3) **While CFC indicator is lit, press the eject key and pull out the memory card from the slot.**

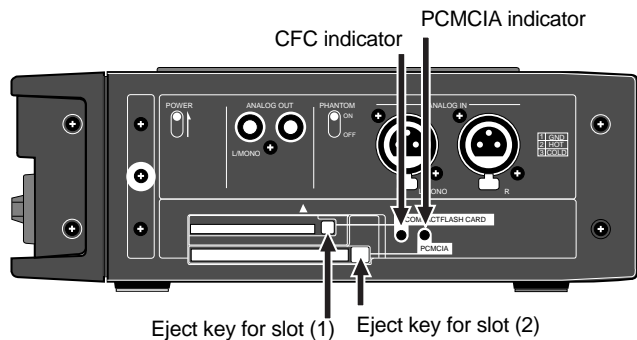

<Notes on ejecting a card when both CFC and ATA are inserted>

When both CFC and ATA are inserted to slots (1) and (2) respectively, pressing the [CARD RELEASE] key brings up the screen as shown below. This screen example shows the current card is a CFC and the power is supplied to the CFC card drive, while an ATA is not mounted. Therefore, you can eject the ATA, while cannot eject the CFC. In this condition, the CFC indicator beside the eject key is unlit, while the PCMCIA indicator is lit. ("Not Mounted" : No power is delivered to the card drive and you can eject the card (the indicator is lit).

```

CARD RELEASE
-----
CFC   :Mounted
PCMCIA:Not Mounted

CFC Release Sure?
[ YES ]/[ NO ]
    
```

"Mounted" and "Not Mounted" shown on screens above mean as below.

" Mounted "	The power is delivered to the card drive (the indicator is unlit). You cannot eject the card until the card is released.
" Not Mounted "	No power is delivered to the card drive and you can eject the card (the indicator is lit).

To remove the CFC, select "YES" on the screen and press the [ENTER] key, then press the eject key after the display shows the screen below.

```

CARD RELEASE
-----
CFC

CARD Release OK!
    
```

Initial format of a memory card

The FR-2 accommodates memory cards formatted with the FAT32(*) file system. In the following procedure, it is assumed that a card, which is formatted with a file system other than FAT32, is loaded, and the display shows the warning message ("Illegal Format!").

- 1) **While the warning message is shown, press the [ENTER] key.**
 The FR-2 goes to the "Format" menu item and the display now shows the caution with flashing "Are you sure?", as shown below.

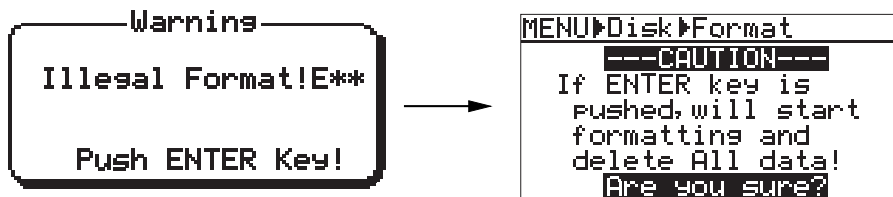

- 2) **If you are sure, press the [ENTER] key again.**
 Formatting starts and the display shows "Please Wait!", followed by "Completed!" when completed, and then returns to the Home screen (note that the "Please Wait!" and "Completed!" screens may not appear when formatting a small size card).



After formatting, no file exists on the card, therefore, "<No Files>" is shown on the Home screen. The remaining time or space on the card for recording is also shown (by default, the remaining time is shown).



Now, the memory card is formatted with the FAT32 file system and you can make recording/playback using it. See "Chapter 5: Basic recording/playback" which starts from page 47.

<Volume label>

A volume label is automatically given when a card is formatted. By default, a volume label is set as below (we call it "default volume label"), depending on the card type. You can edit the default volume label using the "Volume Label" menu item on the "DISK" menu in the MENU mode (see page 77).

<Default volume label examples>

ATA -> "PCM000"

CFC -> "CFC000"

Memo

Chapter 3: Names and functions

<Table of contents>

Front panel	32
Top panel	34
Left side panel	37
Right side panel	37
Bottom panel	38
Details about screens	39
Home screen	39
When no memory card is set in the slot	39
When a virgin memory card is set in the slot	40
When a recorded memory card is set in the slot	40
MENU mode screens	40
Warning messages	41

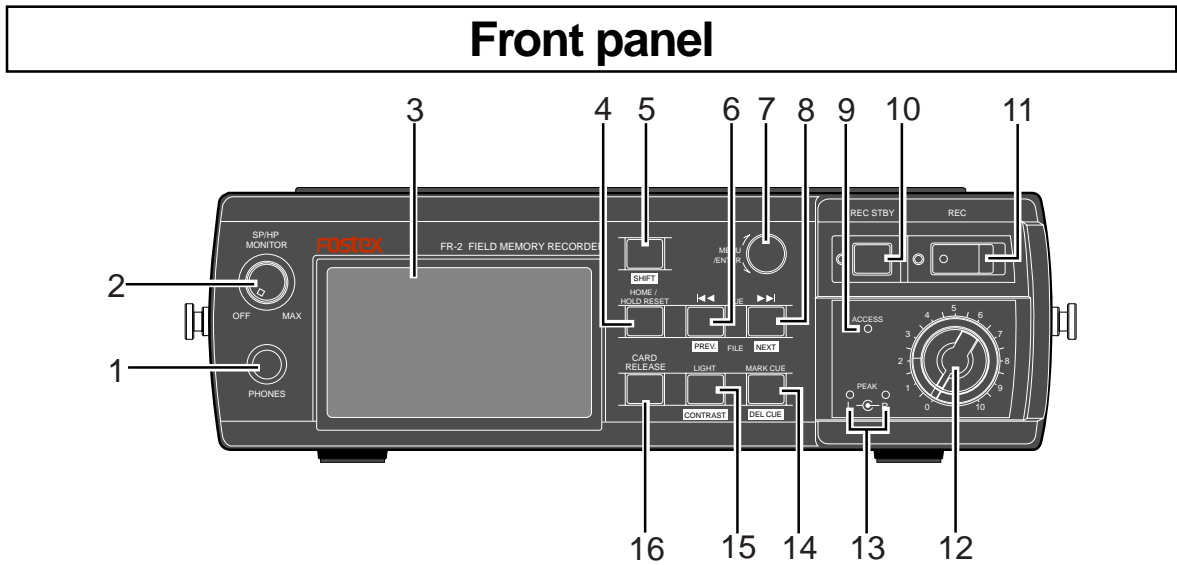

- 1) **[PHONES] jack**
Connects headphones for monitoring.
Inserting a plug automatically disables the internal monitor speaker.
Note that, regardless of the setting of the "Speaker Mute" menu item on the Setup mode in the MENU mode, the [PHONES] jack always feeds audio.
See "Speaker mute function on/off" on page 86 for details about "Speaker Mute" setting.
- 2) **[SP/HP MONITOR] control**
Adjusts the monitor level of headphones and the internal monitor speaker.
You can push down the control to the same level as the panel. Pushing the control again raises it up. Turning the control counterclockwise until clicked turns off the monitor sound.
- 3) **LCD display**
Displays various kinds of information including audio input/output levels, settings, etc.
See "About the LCD display" on page 39 for details.
- 4) **[HOME/HOLD RESET] key**
This key works in the following situations.

 - <While the HOME screen is shown>
Resets the peak hold on the meters.
 - <In the MENU mode>
Exits the MENU mode and returns the display to the HOME screen.
- 5) **[SHIFT] key**
To make a SHIFTEd function active, press a key which provides its SHIFTEd function while holding down the [SHIFT] key.
Each SHIFTEd function is labeled in a rectangular box below the key.
- 6) **[CUE <<<] key**
If cue points (CUE 01 ~ 99) are stored in the current file, pressing this key skips back to the previous cue point. Pressing this key repeatedly skips back to the associated cue point.

When more than one file exists on the card, pressing this key while holding down the [SHIFT] key switches the current file to the previous entry in the file list.

7) **[MENU/ENTER] knob**

You can rotate or press this knob.

[MENU] dial function:

Rotating this knob selects an item from a menu or a character among alphanumeric characters in the MENU mode.

[ENTER] key function:

Pressing this knob completes setting or executes the selected operation.

* In this manual, we sometimes call this knob "[MENU] dial" or "[ENTER] key" according to the function.

8) **[CUE ►►] key**

If cue points (CUE 01 ~ 99) are stored in the current file, pressing this key skips forwards to the next cue point. Pressing this key repeatedly skips forwards to the associated cue point.

When more than one file exists on the card, pressing this key while holding down the [SHIFT] key switches the current file to the next entry in the file list.

9) **[ACCESS] indicator**

This indicator flashes when the FR-2 is accessing a currently selected card (CompactFlash card or Flash ATA card). The indicator may light steadily depending on the FS of a recorded material.

When removing a card, make sure that the [ACCESS] indicator is unlit.

<p><Warning>: Never turns off the power when the [ACCESS] indicator flashes. Data currently being recorded or played back may be damaged.</p>
--

10) **[REC STBY] (RECORD STANDBY) key**

Pressing this key before recording makes the unit record-standby and switches the monitor to "input monitor".

Pressing this key again releases record-standby (and "input monitor").

During recording, pressing this key stops recording (you cannot stop recording using the [STOP] key).

11) **[RECORD] key**

Pressing this key starts recording.

Each time you press this key, a new audio file is created.

For details about the file name of an audio file created when recording, see pages 81 and 82. When the PRE REC mode is set to "ON", the previous data stored in the buffer is also recorded.

12) **Input level controls**

Adjusts the input level of analog audio signals.

The controls for L and R channels are ganged.

13) **[PEAK] indicators**

When an analog audio input signal overloads, the [PEAK] indicator of the associated channel lights. You should set the input level appropriately so that the [PEAK] indicator does not light continuously.

14) **[MARK CUE - DEL CUE] key**

By pressing this key during recording/playback or while stopped, the current position data is stored as a cue point "on the fly".

You can store up to 99 cue points (01 through 99). By default, cue points are labeled as "Mark01", "Mark02", etc. according to the order you store points.

Default cue labels can be edited using the Cue menu in the MENU mode.

By pressing this key while holding down the [SHIFT] key during playback (or while stopped), the cue point before the current position is deleted.

15) [LIGHT - CONTRAST] key

By pressing this key briefly, the backlight of the display lights for three seconds and then automatically turns off.

By pressing down this key for more than two second, the backlight turns continuously on. To turn off the backlight in this condition, press this key again.

<Note>: When operating the unit on batteries, to save the battery power, we recommend not to keep the backlight continuously on unless it is necessary.
 Note that, if you turn off the unit's power while the backlight continuously lights and then turn on the unit, the backlight continuously lights.

You can adjust the display contrast by pressing this key while holding down the [SHIFT] key. See "Before using the FR-2" on page 22 for details.

16) [CARD RELEASE] key

By pressing this key while stopped, the current memory card is released and ready for being removed from the slot. To remove the card from the slot, press the eject key beside the slot. See "About memory cards" on page 24 for details.

Top panel

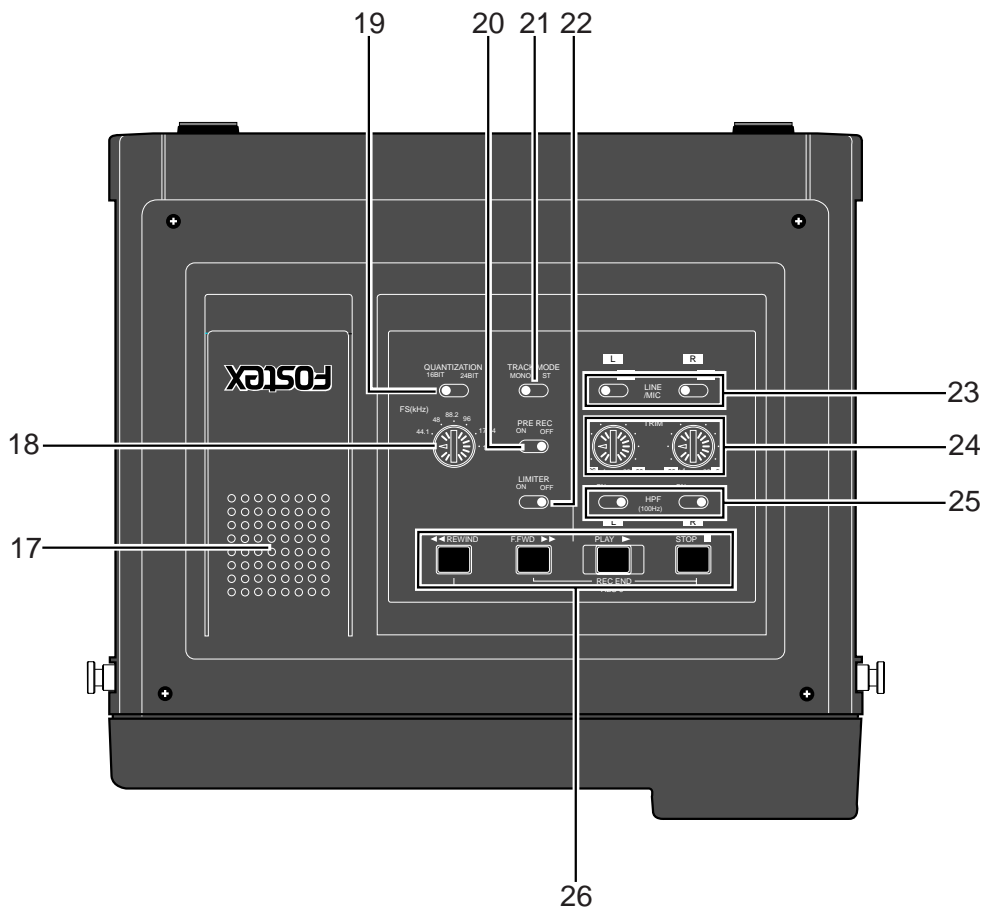

17) Internal monitor speaker

This speaker is used for monitoring.

When a headphones plug is inserted to the [PHONES] jack, this monitor speaker is muted.

You can also select whether or not muting the speaker except during playback using the "Speaker Mute" menu item on the "Setup" menu in the MENU mode.

See "Speaker mute function on/off" on page 86 for details.

Phones	Speaker mute setting	During input monitor	During recording	During playback
Disconnected	Off	Input monitor	Source monitor	Playback monitor
	On	Mute	Mute	Playback monitor
Connected	-	Mute	Mute	Mute

18) [FS (kHz)] switch

Selects a sampling frequency (FS) for recording.

You can select a desired FS from among 22.05, 44.1, 48, 88.2, 96, 176.4 and 192 kHz.

<Note>: When recording a digital source whose FS is unknown, the internal clock locks to the digital source and recording is made with the FS selected by the [FS (kHz)] switch. If the FS of the digital source is 48 or 44.1 kHz, the internal clock locks to the digital source and recording is made with the FS of the digital source.

19) QUANTIZATION switch

Selects a quantization bit (16 and 24 bits) for recording.

You can select from among the following combinations of FS and quantization bit.

16Bit	22.05kHz / 44.1kHz / 48kHz
24Bit	44.1kHz / 48kHz / 88.2kHz / 96kHz / 176.4kHz / 192kHz

20) [PRE REC] switch

Selects ON or OFF of the PRE REC mode.

When it is set to ON, input data is always stored to the internal buffer.

If you start recording when the [PRE REC] switch is set to ON, the previous data is first delivered from the buffer. You may not miss the start of an important event to be recorded.

The time length of audio stored in the buffer depends on the FS setting. You can edit the time length using the "Pre Rec Time" menu item on the Setup menu in the MENU mode. See "Setting the time length stored in the buffer for Pre rec mode" on page 89 for details.

21) [TRACK MODE] switch

Selects the track mode for recording between STEREO and MONO.

MONO	The left channel of a source is recorded in mono.
STEREO	A stereo source is recorded in stereo.

During recording (or input monitor) with the [TRACK MODE] switch set to "MONO", you can monitor the source in mono (positioned in center) via headphones.

22) [LIMTER] switch

Selects ON or OFF of the LIMTER function.

23) [LINE/MIC] switches

These switches select analog input sources of the left and right channels between MIC and LINE. You can select the sources of the left and right channels independently.

24) [TRIM] controls

These controls adjust the analog input levels of the left and right channels.

When the [LINE/MIC] switch is set to LINE	Adjustable within the range between -30 dBu and +4 dBu.
When the [LINE/MIC] switch is set to MIC	Adjustable within the range between -60 dBu and -26 dBu.

25) [HPF] switches

These switches select ON or OFF of the high-pass filter (100 Hz,12 dB/oct).

26) Transport keys

[PLAY] key

Starts playback of the current file.

[STOP] key

Stops the transport.

When the unit is in the MENU mode, pressing this key exits the MENU mode.

Pressing the [F FWD] or [REWIND] key while holding down the [STOP] key moves the transport as follows.

[STOP] + [REWIND]	The transport locates to the beginning (ABS 0) of the current file.
[STOP] + [F FWD]	The transport locates to the record end position (REC END) of the current file.

[F FWD] key

While stopped, pressing this key fast-forwards the transport.

During playback, pressing this key cues the transport in the forward direction at up to double speed.

By pressing this key while holding down the [STOP] key locates the record end point (REC END) of the current file.

[REWIND] key

While stopped, pressing this key rewinds the transport.

During playback, pressing this key cues the transport in the reverse direction at up to double speed.

By pressing this key while holding down the [STOP] key locates the beginning (ABS 0) of the current file.

<Note>: With a file recorded at 176.4 or 192 kHz FS, you cannot operate cueing playback.

Left side panel

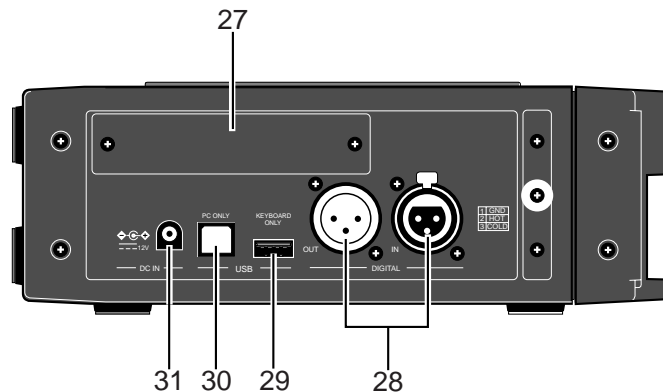

- 27) Slot (for the optional card)**
Prepared for the optional TC IN/OUT card (available soon).
Ask your local Fostex dealer or sale office for installing the optional card.
- 28) [DIGITAL IN]/[DIGITAL OUT] connectors**
Both connectors handle AES/EBU or S/P DIF digital audio signals.
The digital input signal format is automatically detected.

The digital output signal format can be selected using the "DigiOutType" menu item on the "Setup" menu in the MENU mode. See "Setting the digital output signal format" on page 91 for details.
- 29) [USB (KEYBOARD ONLY)] port**
This port is exclusively used for connecting a USB keyboard. By connecting a USB keyboard to this port, you can edit file and cue point names.
See "Basic connection" on 46 page and the "Selecting the USB keyboard type" on page 93.
- 30) [USB (PC ONLY)] port**
This port is exclusively used for connecting a PC. By connecting a PC to this port, you can transfer audio files between the unit and PC.
For details about the file transfer, see "Chapter 7: Exporting files to a PC" on page 97.
- 31) DC IN jack**
This port is used to connect the optional AC adaptor (Model AD12-1300).

Right side panel

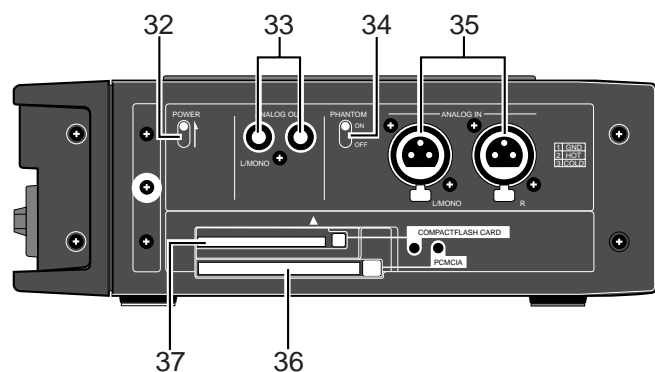

32) [POWER] switch

Turns on or off the unit's power.

33) [ANALOG OUT (L/MONO, R)] jacks (RCA)

These jacks output -10 dBV analog audio signals. A mono signal is output from the [L/MONO] jack.

34) [PHANTOM] switch

By setting this switch to ON, +48 V phantom power is supplied to the microphone(s) connected which requires phantom power.

35) [ANALOG IN (L/MONO, R)] connectors

These connectors accept mic or line level analog audio signals. You can adjust the input level using the [TRIM] controls.

36) PCMCIA slot/eject key/indicator

A Flash ATA card should be inserted to the slot. Depending on the condition, the indicator beside the slot is lit or unlit.

When lit	No power is supplied to the card in the slot. You can remove the card.
When unlit	The power is supplied to the card in the slot. You cannot remove the card.

To remove a card from the slot whose indicator is unlit, press the [CARD RELEASE] key to release the card (the indicator turns on) and then press the eject key. See "About memory cards" on page 24 for details.

37) COMPACTFLASH CARD slot/eject key/indicator

A CompactFlash card should be inserted to the slot. Depending on the condition, the indicator beside the slot is lit or unlit.

When lit	No power is supplied to the card in the slot. You can remove the card.
When unlit	The power is supplied to the card in the slot. You cannot remove the card.

To remove a card from the slot whose indicator is unlit, press the [CARD RELEASE] key to release the card (the indicator turns on) and then press the eject key. See "About memory cards" on page 24 for details.

Bottom panel

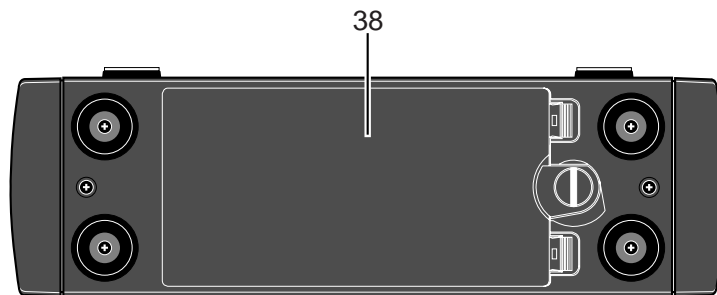

38) Battery compartment

This compartment houses eight AA-type batteries for operating the unit. Use alkaline, Ni-Cd, or Ni-HM batteries. See "About power supply" on page 18 for details.

Details about screens

The FR-2 features 132 x 65 dot LCD display for showing record/playback levels, file information, setting information, realtime clock information, etc.

Home screen

After the unit is turned on and starts up, the "Home screen" appears on the display.

• When no memory card is set

When no memory card is set in the slots, turning on the unit brings up the screen as shown below after the unit starts up. "<NoMemoryCards>" is shown on the screen.

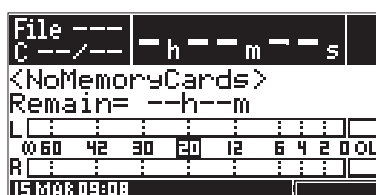

This screen is called "Home screen". During recording or playback, the Home screen is normally shown. On the Home screen, you can see the following information.

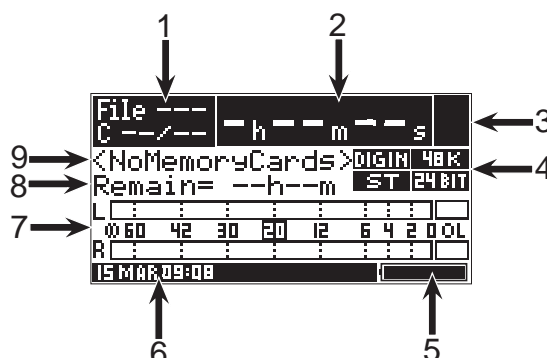

1	File number/Cue information	This area shows the current file number and the cue point information including the total number of cue points currently set.
2	Time counter	This counter shows the current position of the file in ABS time.
3	Transport status	This area shows transport status using symbols. For example, you can see "■" while stopped, or "●" during recording.
4	FS/BIT/TR MODE/DIGI IN information	During recording, the settings of the [FS (kHz)], [QUANTIZATION] and [TRACK MODE] switches are shown. During playback, the FS, quantization bit and track mode information of the current file is shown. "DIG IN" lights when the unit receives a digital input signal.
5	Battery (BATT) indicator	This indicator shows the battery power condition. When using the AC adaptor, this indicator fully lights.
6	Realtime clock indicator	This indicator shows the internal realtime clock data in "day, month, hour and minute".
7	Level meters	These meter show recording/playback levels of L and R channels. The reference level corresponds to -12 dB.
8	Remaining time (or space)	When recording starts (or input monitor is enabled), this area shows the time or space remaining on the memory card for recording. You can select whether to show the remaining time or space (in MBytes) using the appropriate menu item in the MENU mode.
9	File name	This area shows the current audio file name. Up to 16 characters can be shown.

• When a virgin memory card is set

When a virgin memory card (CFC or ATA) is set in the slot, turning on the unit brings up the Home screen as shown below after the unit starts up. You can see "<No Files>", as well as the time or space remaining on the current card for recording. (You can select whether to show the remaining time or space using the setting of the "RemainDisplay" menu item on the "Setup" menu in the MENU item. By default, the remaining time is shown.)

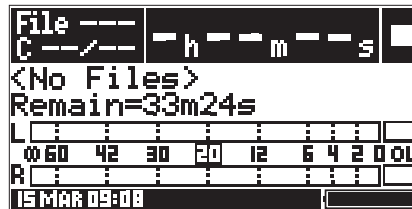

• When a recorded memory card is set

When a recorded memory card (CFC or ATA) is set in the slot, turning on the unit brings up the Home screen as shown below after the unit starts up. The recorder is stopped at the beginning of the current audio file ("File 001").

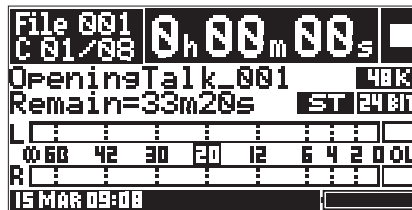

You can turn on or off the backlight of the LCD display, as well as adjust the contrast, allowing you to see the display comfortably on any circumstance. See "Chapter 2: Before using the FR-2" on page 22 for details.

MENU mode screens

By pressing the [ENTER] key while stopped, the FR-2 enters the MENU mode and the display changes to show the MENU mode screen. In the MENU mode, the Cue menu, File menu, Disk menu, Setup menu and USB Mode menu are available. Each menu has various menu items, from which you can make desired settings according to your system or purpose.

"▶" at the right of a menu title shows that the menu has more than one pages. See from page 61 for details about the MENU mode.



Warning message screen

In a case that the operation is inappropriate, entered data is illegal, or an error happens, a warning message screen may appear on the display.

The following shows available warning message screen with comments including remedies. If you encounter any warning message, immediately cope with the trouble.

<p style="text-align: center;">Warning</p> <p style="text-align: center;">Battery Empty!</p>	<p>This message appears when batteries for operating the FR-2 are exhausted. The FR-2 automatically shuts down after showing this warning message. Replace batteries with new (or fully charged) ones.</p>
<p style="text-align: center;">Warning</p> <p style="text-align: center;">RTC Battery Empty! Push ENTER Key!</p>	<p>This message appears when the battery for operating the internal realtime clock is exhausted. This message appears when turning on the power. Ask your local Fostex dealer or sales office for replacing the battery.</p>
<p style="text-align: center;">Warning</p> <p style="text-align: center;">Memory Error! Push ENTER Key!</p>	<p>This message appears when the memory card inserted to the slot has a problem. Replace the card with another one.</p>
<p style="text-align: center;">Warning</p> <p style="text-align: center;">Memory Full! Push ENTER Key!</p>	<p>This message appears when the current memory card does not have enough remaining space for recording. Replace the card with another one which has enough remaining space.</p>
<p style="text-align: center;">Warning</p> <p style="text-align: center;">File Error! Push ENTER Key!</p>	<p>This message appears when the current audio file has a problem. You cannot use this file any more. Delete this file.</p>
<p style="text-align: center;">Warning</p> <p style="text-align: center;">This File is Protected! Push ENTER Key!</p>	<p>This message appears when the current file is protected. Release the protection using the "Protect" menu item on the "File" menu in the MENU mode if you wish to make recording or editing.</p>
<p style="text-align: center;">Warning</p> <p style="text-align: center;">Too Many Files! Push ENTER Key!</p>	<p>This message appears when you cannot create an audio file to the current memory card any more. To create a new audio file, delete an unnecessary file or replace the card to another one.</p>

<p>Warning Cue Data Error! Push ENTER Key!</p>	<p>This message appears when you are going to store illegal cue point data after editing. Enter legal cue point data and store it.</p>
<p>Warning Disk In Error! Push ENTER Key!</p>	<p>This message appears when the digital input signal is illegal during recording a digital source. Check the digital source.</p>
<p>Warning Same Name Exist! Push ENTER Key!</p>	<p>When you are going to store an audio file name, this message appears if a file with the same name already exists in the card. Change the audio file name to be stored.</p>
<p>Warning Can't Delete Protected File! Push ENTER Key!</p>	<p>This message appears when you are going to delete an audio file which is protected. Release the protection using the "Protect" menu item on the "File" menu in the MENU mode.</p>
<p>Warning Illegal Name! Push ENTER Key!</p>	<p>When you are going to store an audio file name, this message appears if the name is illegal. Enter a legal name and store it.</p>
<p>Warning No Memory Cards Push ENTER Key!</p>	<p>When you are going to make setting of any menu item (except for menu items on the Setup menu) in the MENU mode, this message appears if no memory cards are inserted to the slots. Insert a memory card and make setting.</p>

Chapter 4: Basic connections

This chapter describes the basic connection between the FR-2 and external devices.

<Table of contents>

Audio input/output connection	44
Analog audio input connection	44
Digital audio input connection	45
Analog audio output connection	45
Digital audio output connection	45
PC/keyboard connection	46
Connecting the FR-2 to a PC	46
Connecting the FR-2 to a USB keyboard	46

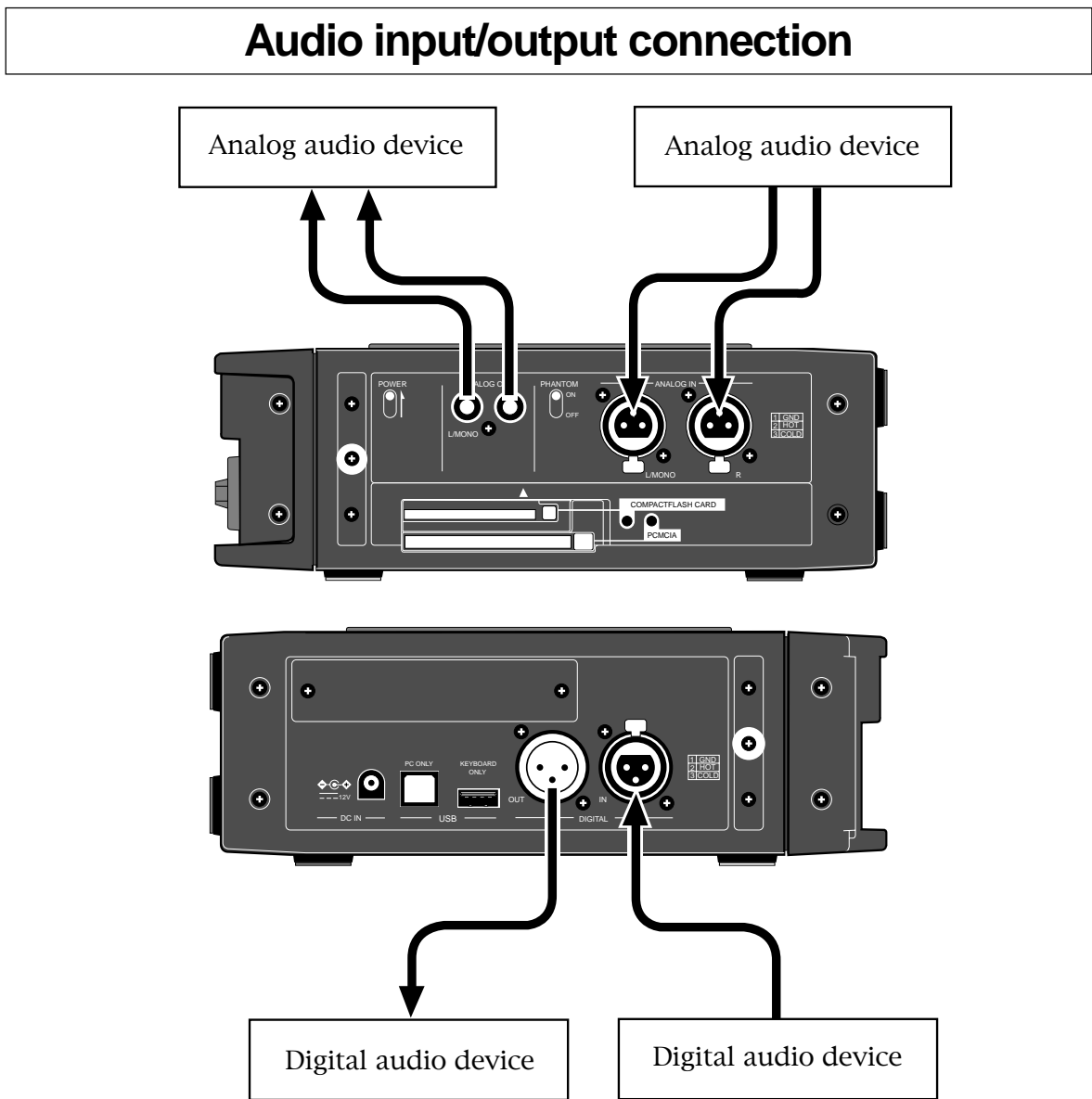

Analog audio inputs

The FR-2 provides two [ANALOG IN] connectors (XLR-3-31, pin 2 hot) which accept two mono or a stereo pair of balanced analog audio source signals. Each audio input accepts signals of a wide range of nominal input level from -60 dBu (microphone level) to +4 dBu (line level).

You can adjust the level using the [TRIM] controls in conjunction with the [LINE/MIC] input selector.

When the [LINE/MIC] switch is set to LINE	Adjustable within the range between -30 dBu and +4 dBu.
When the [LINE/MIC] switch is set to MIC	Adjustable within the range between -60 dBu and -26 dBu.

The FR-2 can provide +48 V phantom power for condenser microphones. It is also equipped with a HPF (High pass filter) and limiter circuit for each input channel.

Digital audio input

The FR-2 accepts digital signals conformed to IEC 60958 (AES/EBU) or IEC 60958 (S/P DIF) format via the [DIGITAL IN] connector (XLR-3-31, pin 2 hot). During recording, the FR-2 automatically detects the format of the digital source.

When the FR-2 receives a digital signal from the [DIGITAL IN] connector, PLL (Phased-locked loop) activates and the FR-2 locks to the sync signal in the digital input source.

<Note>: When receiving a digital source which contains FS information, the FR-2 makes recording according to the FS of the digital source regardless of the [FS (kHz)] switch setting.

When recording a digital source which does not contain FS information, the FR-2 makes recording according to the [FS (KHZ)] switch setting.

When receiving a digital source which does not contain FS information and making the unit "input monitor" (record-standby), "DIG IN" is shown in inverse video on the display.

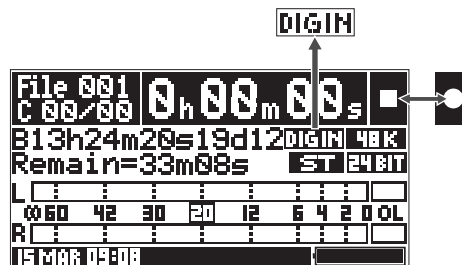

<Note>: During recording of analog audio, the FR-2 does not receive a digital input signal.

<Note>: The FR-2 does not accept digital signals at 176.4 kHz and 192 kHz.

Analog audio outputs

The [ANALOG OUT] jacks (unbalanced RCA) output -10 dBV analog audio signals.

Digital audio output

The digital audio signals can be output from the [DIGITAL OUT] connector in the IEC 60958 (AES/EBU) or IEC 60958 (S/P DIF) format.

You can select the digital output signal format (AES/EBU or S/P DIF) using the "Digital Out Type" menu item on the "Setup" menu in the MENU mode (the default is "AES/EBU").

A balanced XLR-3-32 type (pin 2 hot) connector is used.

<Note>: The [DIGITAL OUT] connector does not support digital signals at 176.4 kHz and 192 kHz.

PC/keyboard Connection

Connecting the FR-2 to a PC

The FR-2 provides the [USB (PC ONLY)] connector which is exclusively used for connecting to a PC. By connecting this connector to a PC, you can control the current memory card of the FR-2 from the personal computer. See page 97 for details about audio file export/import.

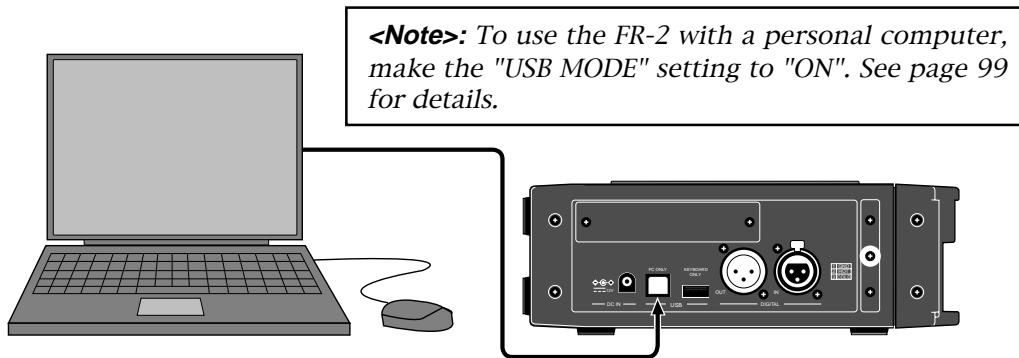

Connecting the FR-2 to a USB keyboard

The FR-2 provides the [USB (KEYBOARD ONLY)] connector which is exclusively used connecting to a USB keyboard. By connecting a USB keyboard to this connector, you can enter file/label names, as well as carry out some of menu operations, from the keyboard.

- <Notes>**

 - **The FR-2 must be powered off when connecting or disconnecting a USB keyboard.**
 - To control the FR-2 from a USB keyboard, make setting of the "Keyboard" menu item on the Setup menu appropriately ("US" or "JAPAN") according to the keyboard connected. See "Selecting the USB keyboard type" on page 93 for details.
 - With some keyboards, indicators may not light until pressing any key after connection is made.
 - Fostex does not guarantee keyboard operations if you use a keyboard with built-in USB hub, USB mouse or PS2 mouse.

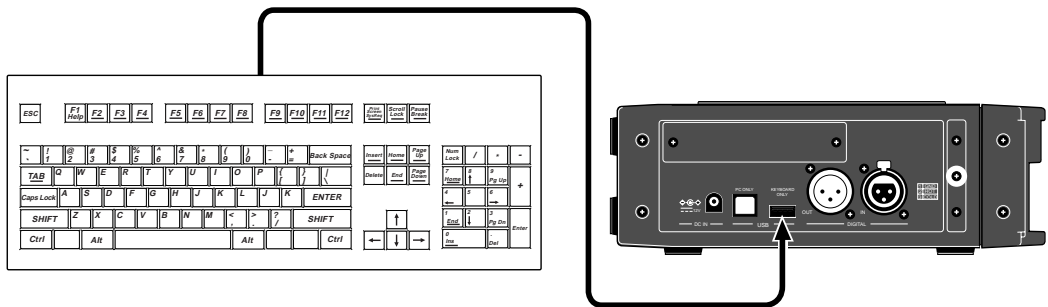

For details about functions you can operate from a USB keyboard, see the description of each menu item with which you can use a keyboard.

Chapter 5: Recording/playback

This chapter describes basic analog and digital audio recording/playback, as well as cue point setting and the skip/locate function.

<Table of contents>

About recording system	48
Recording analog audio	49
Selecting the input source	49
Adjusting the input gain	49
Filter setting	49
Limiter setting	50
Selecting the sampling frequency/quantization bit length	50
Selecting the track mode	51
Adjusting the recording level	51
Monitoring recording signals	52
Checking the remain for recording	52
Making recording	53
Recording with PRE REC active	54
About overloading	54
Recording digital audio	55
Selecting the track mode	55
Selecting the sampling frequency/bit length	55
Setting cue points	56
Setting a cue point on-the-fly	56
Viewing cue point information	57
Deleting a cue point in realtime	57
Playback	58
Normal audio playback	58
Cueing playback	58
Skip/locate functions	59
Skipping by file	59
Skipping by cue point	59
Locating to the beginning (ABS 0) of a file	59
Locating to the end (REC END) of a file	59
Locating to the desired cue point	59

About recording system

The FR-2 uses the FAT32 (File Allocation Table 32) file system and supports the most common BWF (Broadcast Wave File) file format.

You can make recording in the stereo (L/R) or mono track mode. When recording in stereo, two (L and R) WAV files are created, while a single WAV file is created when recording in mono.

A BWF file created is stored in the "bwff" folder which is created on a CFC/ATA (see the figure below). The FR-2 uses the "1 take - 1 file" system. With this system, each time you make recording, a new audio file is created on the card. Note that you cannot make additional recording or overwriting to an existing file.

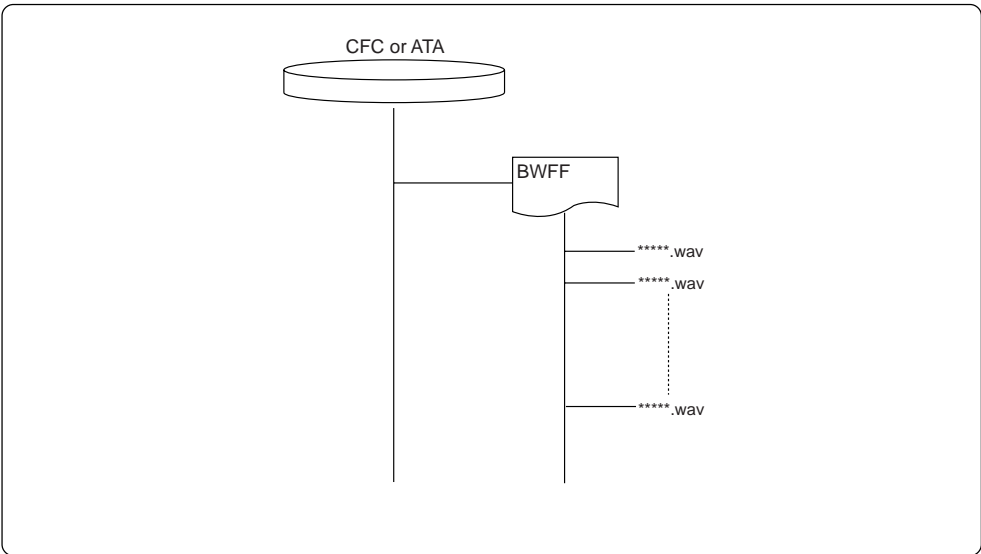

By connecting the FR-2 to your PC, you can transfer an audio file recorded by the FR-2 to the PC, and vice versa. Therefore, you can copy an audio file recorded by the FR-2 to a PC hard drive or export it to a computer application such as Digidesign Pro Tools.

The table below shows the approximate recording time on a 1GB card (CFC or ATA). Note that actual recording time may be slightly different depending on card manufacturers.

FS/BIT	Recording time in stereo	Recording time in mono
22.05kHz / 16bit	Approx. 192 minutes	Approx. 384 minutes
44.1kHz / 16bit	Approx. 96 minutes	Approx. 192 minutes
44.1kHz / 24bit	Approx. 64 minutes	Approx. 128 minutes
48kHz / 16bit	Approx. 90 minutes	Approx. 180 minutes
48kHz / 24bit	Approx. 60 minutes	Approx. 120 minutes
88.2kHz / 24bit	Approx. 32 minutes	Approx. 64 minutes
96kHz / 24bit	Approx. 30 minutes	Approx. 60 minutes
176.4kHz / 24bit	Approx. 16 minutes	Approx. 32 minutes
192kHz / 24bit	Approx. 15 minutes	Approx. 30 minutes

Recording analog audio

To record analog audio, some control and switch settings are necessary.

Selecting the input source

Set the [LINE/MIC] switch for each (L, R) channel appropriately according to the source (microphone or line) connected to the associated [ANALOG IN] (L/MONO or R) connector.

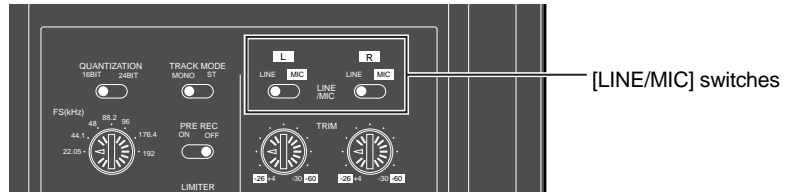

Adjusting the input gain

Using the [TRIM] control for each (L, R) channel, you can adjust the input gain for the associated channel to accept signal within the following nominal input level range.

When the [LINE/MIC] switch is set to "LINE"	Between -30 dBu and +4 dBu
When the [LINE/MIC] switch is set to "MIC"	Between -60 dBu and -26 dBu

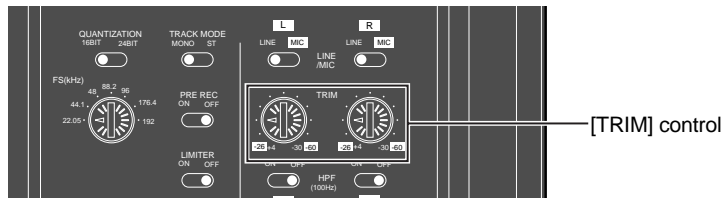

High-pass Filter

The FR-2 is equipped with the high-pass filter circuit. The cutoff frequency is 100 Hz and the filter slope is -12 dB/oct. The [HPF] switch, which selects ON or OFF of the high-pass filter, is provided for each channel.

The filter is useful to eliminate the wind noise during location recording or unnecessary low frequency noise when recording a voice or sound.

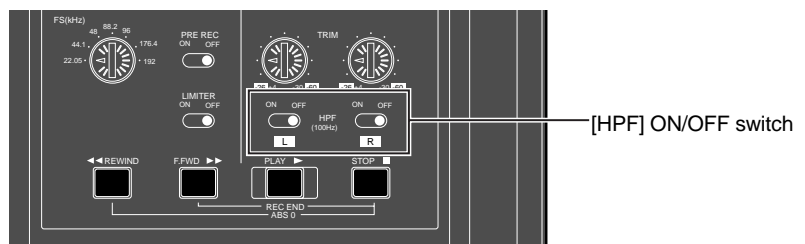

Limiter

By using the limiter, the signal level is prevented from exceeding a certain level. In result, the signal level fluctuation is suppressed. Therefore, the limiter is useful when recording a sound whose level is unknown. You can activate the limiter for both L and R channels by setting the [LIMITER] switch to "ON".

The FR-2 limiter uses the VCA (Voltage Controlled Amplifier) circuit. By default, the threshold is -2 dB under the 24-bit full-scale level (all bits: ON) and the compression ratio is 1:5. The limiter attack time is fixed to approximately 20 ms, while the release time is fixed to approximately 150 ms.

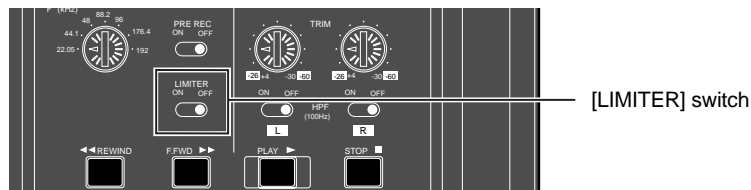

Selecting the sampling frequency/quantization bit length

You can select the desired sampling frequency ("FS " for short) and quantization bit length ("Bit" for short) for recording by using the [FS (kHz)] and [QUANTIZATION] switches on the top panel.

You can select the FS from among 22.05 kHz, 44.1 kHz, 48 kHz, 88.2 kHz, 96 kHz, 176.4 kHz and 192 kHz, while you can select the Bit between 16 and 24 bit. The current FS and Bit settings are shown on the Home screen. See the available combination of FS and Bit settings in the table below.

While receiving a digital signal, the FR-2 automatically detects the FS and Bit from the receiving digital signal, which takes priority over the [FS (kHz)] and [QUANTIZATION] switch settings.

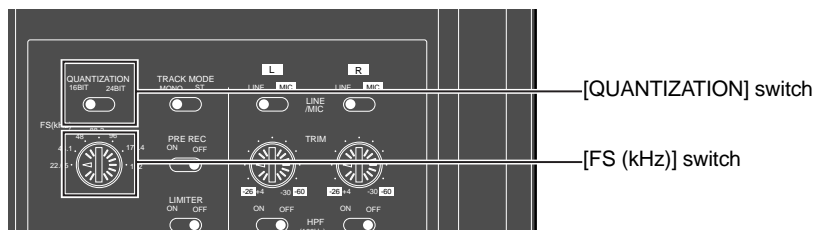

FS (kHz)	BIT	
	16bit	24bit
22.05	Yes	
44.1	Yes	Yes
48.0	Yes	Yes
88.2		Yes
96		Yes
176.4		Yes
192		Yes

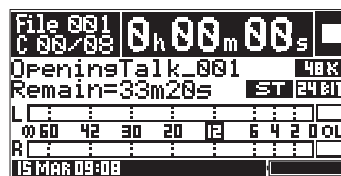

<Note>: During recording (or input monitor), the FS and Bit follow the current switch settings. While stopped (or during playback), the FS and Bit recorded on the current file are shown.

<Note>: During recording, you cannot change FS and Bit setting. If you change the [FS] select switch setting during recording, the switch setting becomes effective when recording stops.

Selecting the track mode

According to the situation, select the track mode (whether making recording in mono or stereo) using the [TRACK MODE] switch.

The [TRACK MODE] switch setting is shown on the Home screen.

MONO	The FR-2 records only the analog "L" input channel signal to a single file.
STEREO	The FR-2 records the L and R analog stereo input signals to two individual files.

<Note>: You cannot change the track mode during recording.

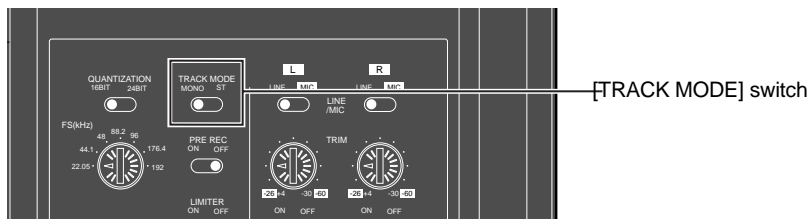

Adjusting the recording level

The recording level for each channel can be adjusted using the [LEVEL] controls after pressing the [REC STBY] key to enable "input monitor". The L and R [LEVEL] controls are ganged.

Pressing the [REC STBY] key again releases "input monitor".

<Notes>

- Adjust the recording level appropriately so that the level meter does not exceed "0 dB". To get the maximum signal-to-noise performance, set the recording level appropriately so that the meter indication does not exceed "0 dB" but goes up near to the "0 dB" at the loudest part of the input signal. The reference level is set to the "-20 dBFS" relative to digital full-scale. "20" on the meter is labeled in inverse video, showing that it is the reference position.
- You can set the unit to generate the error tone when the input amplifier clips due to over level by using the "Error tone" menu item on the Setup menu in the MENU mode. See "Setting error tone output condition" on page 87 for details.

The file name field shows realtime counter data which is running.

During record standby, "■" and "●" are alternately flashing here.

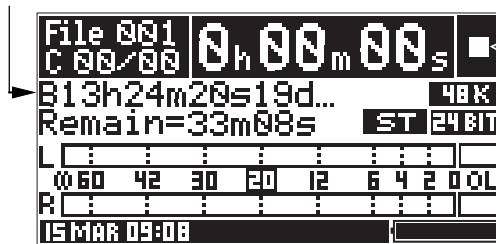

<Screen example during input monitor>

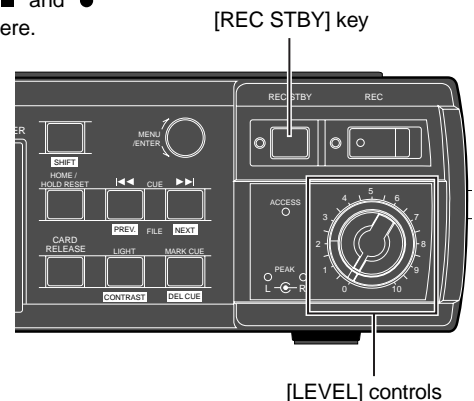

Monitoring recording signals

You can monitor recording signals via headphones (or the internal monitor speaker). Inserting a plug to the [PHONES] jack automatically disengages the internal speaker, and you can monitor the signals only via headphones.

The monitor level can be adjusted by the [SP/HP MONITOR] control. This control is a pushlock type. Pressing on the control knob raises it above the panel to permit level adjustment. Pressing the control again recesses the knob to avoid accidental setting changes.

To turn off the monitor sound completely, rotate the control fully counterclockwise until it clicks.

When recording in mono	You can monitor the recorded signal in mono (center panning) via the [PHONES] jack.
When recording in stereo	You can monitor the recorded signal in stereo via the [PHONES] jack.

<Note>: While operating the FR-2 on batteries, we recommend not to raise the monitor volume more than required. Raising the volume consumes more battery power.

Checking the remain for recording

You can see the remaining time or space (in MBytes) of the current memory card (by default, remaining time).

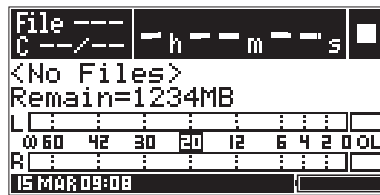

The remaining space is shown.

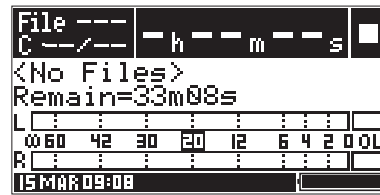

The remaining time is shown.

The remaining time is calculated based on the current [FS (kHz)] and [QUANTIZATION] switch settings.

Depending on the recorder status, the display shows the remaining value as follows.

Any condition except during recording and input monitor	The total remaining time or space of the current memory card is shown.	
During recording and input monitor	When the remaining space of the current memory card is more than 2 GBytes	When the remaining space is more than 2 GBytes, "2000MB" or the equivalent time value is shown.
	When the remaining space of the current memory card gets less than 2 Gbytes	The current remaining time or space is shown.
<Note> : The remaining time is shown in "h**m" when it is over 60 minutes, while it is shown in "m**s" when it lowers 60 minutes.		

Making recording

After making the necessary switch/level settings for recording, you can start recording. The following description is assumed that no recording has been made to the current memory card ("**<No Files>**" is shown).

<Note>: The digital input signal takes priority over the analog input signals. Therefore, when the FR-2 is receiving only analog audio input signals, you can record these analog input signals. However, when the FR-2 is also receiving a digital signal from the [DIGITAL IN] connector as well as analog signals, you cannot record the analog signals.

<Note>: Even if you use a memory card of more than 2GB size, the maximum recording space for a file is 2GB. You can set the unit to generate the error tone when the remaining time gets shorter than the specified time by using the "Error Tone" menu item on the Setup menu in the MENU mode. See "Setting error tone output condition" on page 87 for details.

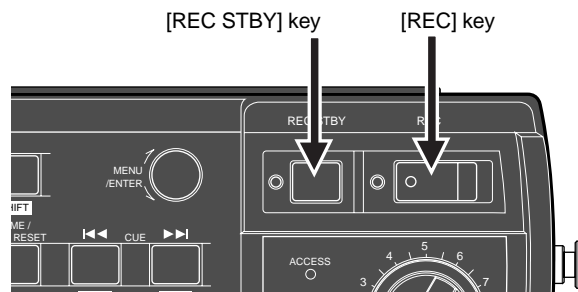

1. Press the [REC STBY] key to make the unit in the record-standby status, and then slide the [REC] key to start recording.

The FR-2 creates a new audio file ("File001") and starts recording.

By default, the real-time clock time data is given as the file name when an audio file is created (for example, "B13h 24m 20s 19d...").

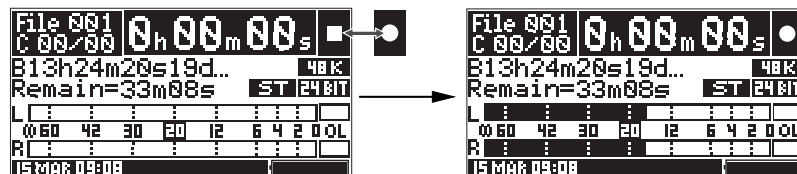

<Note>: If you press the [REC] key without pressing the [REC STBY] key in advance (i.e. the recorder is not in the record-standby status), it takes approximately one second to start recording. To prevent missing the start of an important event to be recorded, we recommend pressing the [REC STBY] key to make the unit in the record-standby status before start recording.

<Note>: Using the "Default file name" menu item on the Setup menu in the MENU mode, you can set the default file name given when an audio file is created to "desired scene name + take number" (the "SCENE NAME + TAKE NUMBER" option) instead of the real-time clock time data (the "DATE" option). See "Setting the default file name" on pages 81 and 82 for details.

2. To stop recording, press the [REC STBY] key.

During recording, only the [REC STBY] key is valid. You cannot use the [STOP] key to stop recording. If you press the [REW] key while holding down the [STOP] key after stopping recording, the recorder locates to the beginning of the newly created audio file. You can review the recording by pressing the [PLAY] key in this condition.

<Note>: Every time you start recording after stopping recording, a new audio file is created and recording is made from the beginning of the new file ("one take - one file"). Each time a file is created, the file number increases.

Recording with PRE REC active

If you start recording when the [PRE REC] switch is set to ON, the previous data is first delivered from the buffer. You may not miss the start of an important event to be recorded.

You can edit the time length of audio stored in the buffer in one second steps using the "Pre rec time" menu item on the Setup menu in the MENU mode. The adjustable range of the time length depends on FS. See page 89 for details.

Note that recording stops after executing "post recording" which records audio data currently stored in the buffer (actually, the incoming audio data is first stored in the buffer and then recorded to the card, therefore, there is a time lag).

<Caution>: If you change the FS setting just before starting recording with the Pre rec mode active, wait for 10 or more seconds before starting recording. Otherwise, the audio signal currently stored in the buffer is recorded with altered pitch.

<Note>: Until the buffer is filled with audio data, the [REC STBY] indicator flashes. When it is filled up, the [REC STBY] steadily lights.

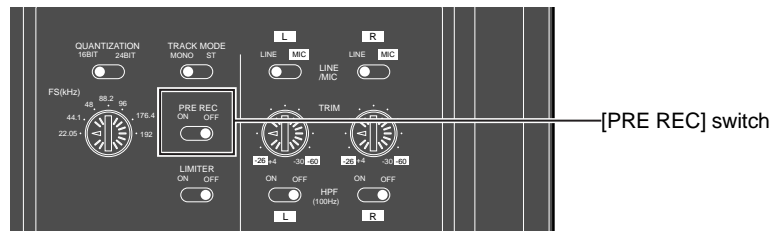

About overloading

When the FR-2 receives analog audio signals and the input amplifier (for L or R) clips, the corresponding PEAK indicator lights up in red.

You can also set the FR-2 to generate the error tone from the internal speaker or headphones for warning when the input amplifier clips.

The setting can be done from the "Error tone" menu item on the Setup menu in the MENU mode. See "Setting error tone output condition" on page 87 for details.

<Note>: Note that if the [SP/HP MONITOR] control is set to "OFF", you cannot hear the error tone.

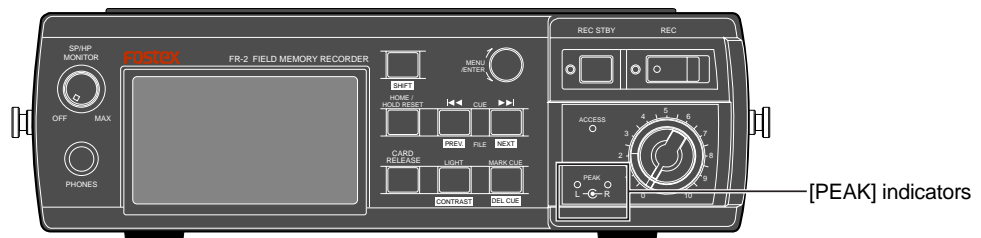

Recording digital audio

Before executing recording of digital audio, you have to make the following settings. You do not have to adjust the input level. See also "Monitoring recording signals" and "Recording with PRE REC active" described earlier in "Recording analog audio". The description can be applied to the digital audio recording.

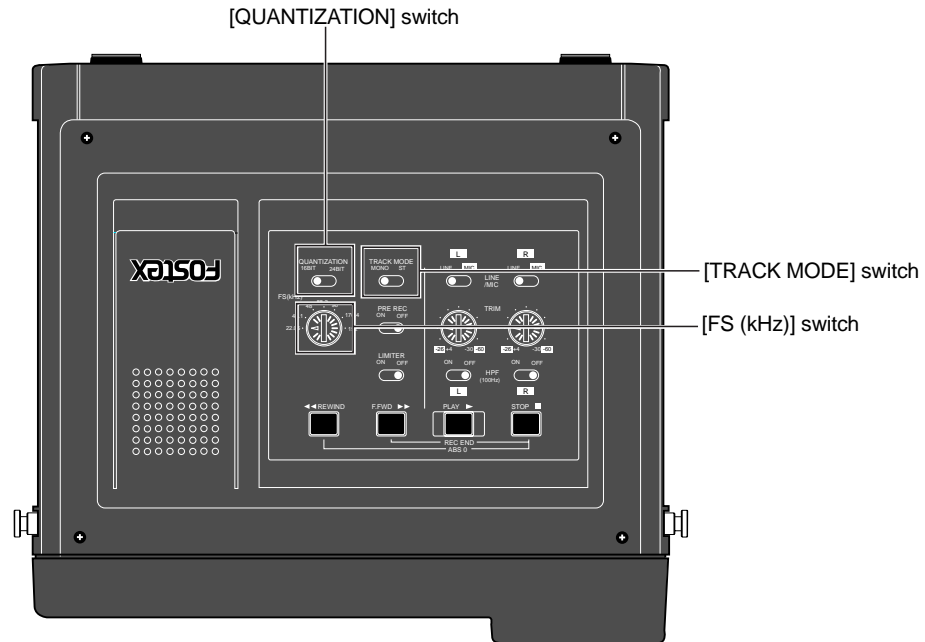

Selecting the track mode

According to the situation, select the track mode (whether making recording in mono or stereo) using the [TRACK MODE] switch. The [TRACK MODE] switch setting is shown on the Home screen.

MONO	The FR-2 records only the L channel signal in the digital input signal to a single file.
STEREO	The FR-2 records L and R signals in the digital input signal to two individual files.

<Note>: You cannot change the track mode during recording.

Selecting the sampling frequency/quantization bit length

The FR-2 records a digital audio signal at the same FS as the source signal if it contains FS information. However, if a source signal does not contain FS/Bit information, the FR-2 follows the settings of the [FS (kHz)] and [QUANTIZATION] switches on the top panel. While the FR-2 is receiving a digital signal which does not contain FS information, "DIG IN" is shown in inverse video (see pages 39 and 45 for details).

<Note>: The FR-2 does not support digital signals at 176.4 kHz and 192 kHz FS.

Setting cue points

The FR-2 can store cue points, which can be used as markers. You can manually set and store a cue point at the desired position during recording (or while stopped).

<About MARK 00 and MARK E>

When you finishes audio recording, the FR-2 automatically set "MARK00" and "MARK E" at the beginning and end points of the recording, respectively. These points correspond to "ABS 0" and "REC END" points, to which you can locate or skip. Note that, unlike other cue points you store at desired positions, you cannot delete these points, as well as edit point data and names.

Setting a cue point on-the-fly

You can set a "cue point" at the position you press the [MARK CUE] key during recording/playback or while stopped. Up to 99 cue points can be set (stored).

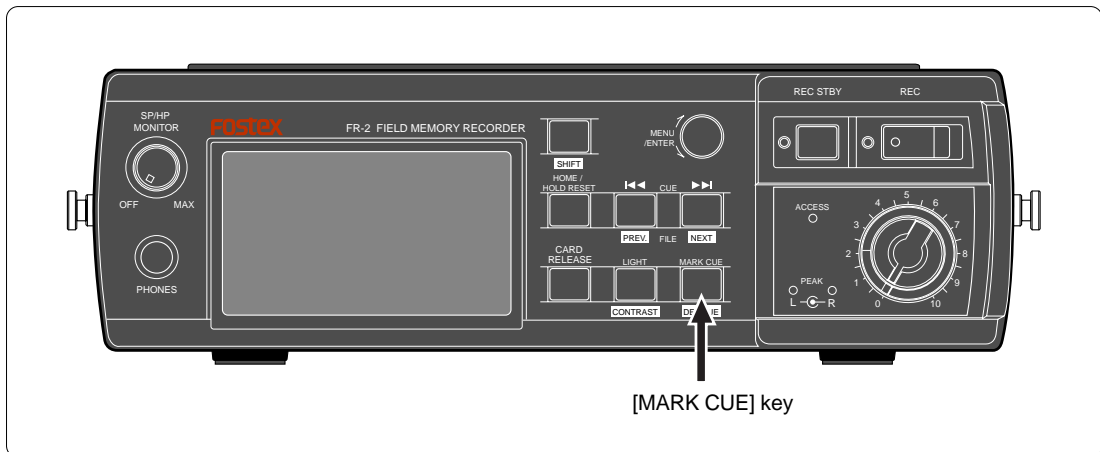

Pressing the [MARK CUE] key sets a cue point at the current position. The least number unused for the existing cue numbers is assigned to the cue number automatically.

<About default cue name>

A default cue name (from among Mark01 through Mark99) is given to a cue point you set at the desired position. You can edit the default cue name using the "Rename" menu item on the Cue menu in the MENU mode. See "Editing a cue name" on page 64.

Cue points stored can be used for the locate and skip functions.

From the Cue menu in the MENU mode, the following functions regarding cue points are available.

- * **Editing a cue name**
- * **Editing a cue position**
- * **Locating to a cue point**
- * **Deleting a cue point**

See "MENU mode" from page 63 for details about cue name editing, cue position editing and cue point deletion. See "Locate/skip functions" on page 59 for details about cue point location.

Viewing cue point information

On the Home screen, you can see the total number of cue points currently stored, as pointed by the arrow below.

In the screen example below, eight cue points are currently stored and the current recorder position is "ABS 0".

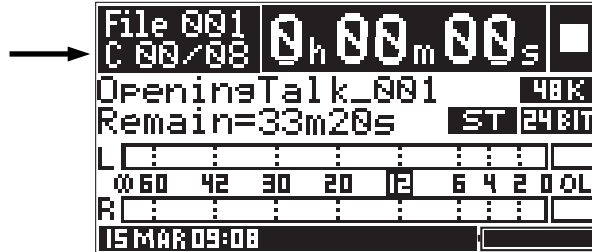

<About cue point information>

The cue point information field on the Home screen looks different depending on the current recorder position and the total number of cue points currently stored.

The following table shows some examples of cue point information.

This information field helps you when deleting a cue point (see the next paragraph below).

"C 00/08"	The total number of cue points currently stored is eight. The current recorder position is between ABS 0 and CUE 01 (including ABS 0, excluding CUE 01).
"C 02/08"	The total number of cue points currently stored is eight. The current recorder position is between CUE 02 and CUE 03 (including CUE 02, excluding CUE 03).
"C 00/00"	No cue point is stored. The current recorder position is between ABS 0 and REC END (including ABS 0, excluding REC END).
"C E/08"	The total number of cue points currently stored is eight. The current recorder position is REC END.

Deleting a cue point in real-time

During playback (or while stopped), pressing the [MARK CUE] key while holding down the [SHIFT] key deletes the cue point before the current recorder position in real-time.

For example, if the cue point information on the Home screen shows "C 03/08", operating as above deletes cue 03.

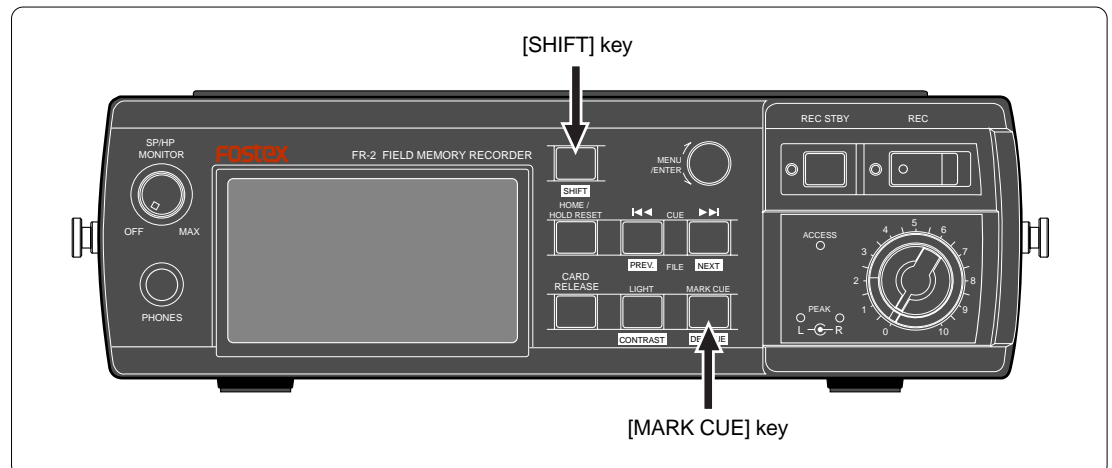

Playback

Normal audio playback

- 1) **Make sure that a recorded card is set to the slot.**
- 2) **Select a desired audio file.**
 You can select an audio file by either of the following two ways.

<Selecting using the CUE (◀◀/▶▶) keys>
 While the recorder is stopped, pressing the [◀◀] or [▶▶] key while holding down the [SHIFT] key selects the previous or next audio file (the recorder skips to the beginning of the selected file).

<Selecting an audio file using the "Select" menu item on the File menu>
 Pressing the [ENTER] key while the recorder is stopped enters the MENU mode, and the display shows the screen for selecting a menu.
 Use the [MENU] dial to select "File" and press the [ENTER] key.
 The display now shows the file list.
 Use the [MENU] dial to select the desired file and press the [ENTER] key. In the screen example below, file names are given with the "Default file name" set to "Date".

```

MENU(1/1)▶
◀◀Back
Cue ▶
▶File ▶
Disk ▶
Setup ▶
USB Mode ▶
                    
```

→

```

MENU▶File(01/01)▶
▶◀◀Back
001:B02h15m20s 19d... ▶
002:B04h31m16s 19d... ▶
003:B06h00m33s 19d... ▶
004:B12h08m45s 19d... ▶
005:B18h42m01s 19d... ▶
                    
```

The display now shows the Home screen, on which you can see the recorder stops at the beginning of the selected file.

- 3) **Press the [PLAY] key to start playback.**
 The [PLAY] indicator is lit.
- 4) **The playback sound can be monitored via headphones or the internal speaker.**
- 5) **To stop playback, press the [STOP] key.**

Playback in the CUE mode (Cueing playback)

During playback, pressing the [F FWD] (or [REW]) key enters the cue mode. In this mode, you can hear the playback sound at up to twice the normal speed in the forward direction or at the normal speed in the reverse direction.

<Note>: Cueing playback is not possible with a file recorded at 176.4 or 192 kHz FS .

Skip/locate functions

The FR-2 offers comprehensive skip/locate functions.

Skipping by file

When more than one audio file is created on the current card, you can immediately skip to the beginning (ABS 0) of a desired track.

When the recorder is stopped, pressing the [◀◀] or [▶▶] key while holding down the [SHIFT] key skips forward or backward a file. Therefore, by pressing the [◀◀] or [▶▶] key as many times as required, you can skip to the beginning of the desired file.

Skipping by cue point

You can immediately skip to a desired cue point on the current audio file.

By pressing the [◀◀] or [▶▶] key while the recorder is stopped, you can skip to the next or previous cue point.

Locating to the beginning (ABS 0) of a file

While the recorder is stopped, pressing the [REWIND] key while holding down the [STOP] key locates to the beginning (ABS 0) of the current file immediately.

Locating to the end (REC END) of a file

While the recorder is stopped, pressing the [F FWD] key while holding down the [STOP] key locates to the record end position (REC END) of the current file immediately.

Locating to the desired cue point

You can locate the recorder immediately to a desired cue point by selecting the cue point from the cue list.

- 1) **While the recorder is stopped, press the [ENTER] key to enter the MENU mode.**
- 2) **Use the [MENU] dial to select "Cue" and press the [ENTER] key.**
The current cue point list is shown on the display.
- 3) **Use the [MENU] dial to select the desired cue point and press the [ENTER] key.**
The display now shows the Cue menu for selecting a desired cue menu items.
- 4) **Use the [MENU] dial to select "Locate" and press the [ENTER] key.**
The recorder immediately locates to the selected cue point and the display returns to the Home screen.

Memo

Chapter 6: MENU mode

<Table of contents>

Menu mode outline	62
Cue menu	63
Locating to a cue point (Locate)	63
Renaming a cue point (Rename)	64
Editing time data of a cue point (Edit)	66
Deleting a cue point (Delete)	67
File menu	68
Selecting an audio file to be played back (Select)	68
Renaming an audio file (Rename)	69
Deleting an audio file (Delete)	70
Audio file protection on/off (Protect)	72
Restoring an audio file (Restore)	73
Disk menu	72
Selecting the current memory card (Select)	72
Optimizing a memory card (Optimize)	75
Formatting a memory card (Format)	76
Editing a volume label of a memory card (Volume Label)	77
Viewing information of a memory card (Disk Info.)	79
Setup menu	80
Selecting default file name type (File Name Mode)	81
Setting the default file name (Default File Name)	82
Adjusting the real time clock (Adjust Real Time)	85
Speaker mute function on/off (Speaker Mute)	86
Setting error tone output condition (Error Tone)	87
Setting the peak hold time of the level meters (Peak Hold Time)	88
Setting the time length stored in the buffer for Pre rec mode (Pre Rec Time) ...	89
Selecting the remain display mode (Remain Display)	90
Setting the digital output signal format (Digi Out Type)	91
Selecting the battery type (Battery)	92
Selecting the USB keyboard type (Keyboard)	93
Checking the ROM version (Version)	94
Initializing settings of the Setup menu (Init Setup)	95

Menu mode outline

By pressing the [ENTER] key while the recorder is stopped, the FR-2 enters the MENU mode and the display changes to show the screen as below.

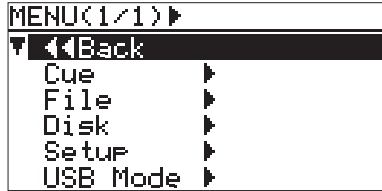

This screen is the first layer in the MENU mode and used for selecting the desired menu. As you can see on the screen above, the available menus are "Cue menu", "File menu", "Disk menu", "Setup menu" and "USB Mode menu".

On each menu, the following menu items are available.

By selecting "◀◀Back" and pressing the [ENTER] key, you can return to the previous screen.

Menu	Description	Menu items
Cue menu	This menu offers items regarding existing cue points.	<ul style="list-style-type: none"> * Locate (Locating to a cue point) * Rename (Renaming a cue point) * Edit (Editing a cue point) * Delete (Deleting a cue point)
File menu	This menu offers items regarding existing audio files.	<ul style="list-style-type: none"> * Select (Selecting a file) * Rename (Renaming a file) * Delete (Deleting a file) * Protect (Protecting a file) * Restore (Restoring a deleted (hidden) file)
Disk menu	This menu offers items regarding memory cards.	<ul style="list-style-type: none"> * Select (Selecting the current drive) * Optimize (Optimizing a card) * Format (Formatting a card) * Volume Label (Editing a volume label of a card) * Disk Info (Viewing information of a memory card)
Setup menu	This menu offers preferences/setup items of the FR-2.	<ul style="list-style-type: none"> * File Name Mode (Selecting default file name type) * Default Scene Name (Setting the default scene name and take number used for a file name) * Adjust Real Time Clock (Adjusting the real time clock) * Speaker Mute (Speaker mute function on/off) * Error Tone (Setting error tone output condition.) * Peak Hold Time (Setting the peak hold time of the level meters) * Pre Rec Time (Setting the time length of audio stored in the buffer) * Remain Display (Selecting the remain display mode) * Digi Out Type (Setting the digital output signal format) * Battery (Selecting the battery type) * Keyboard (Selecting the USB keyboard type) * Version (Checking the ROM version) * Init Setup (Initializing settings of the Setup menu)
USB mode menu		<ul style="list-style-type: none"> * USB mode on/off for file transfer between the FR-2 and a PC

See the following pages in this chapter for details about each menu item, except for the USB mode menu which is described in "Chapter 7: Exporting files to a PC".

Cue menu

The Cue menu offers the following four menu items.

- * **Locate:** locating to a desired cue point
- * **Rename:** Renaming a cue point
- * **Edit:** Editing time data of a cue point
- * **Delete:** Deleting a cue point

<Note>: To carry out operations of Cue menu items, one or more cue points must be set to the current audio file.

Locating to a cue point (Locate)

The following description is assumed that the FR-2 is now in the MENU mode by pressing the [ENTER] key while the recorder is stopped.

- 1) Use the [MENU] dial to select "Cue" and press the [ENTER] key.

The display now shows the cue point list in which all cue points stored in the current file are shown.

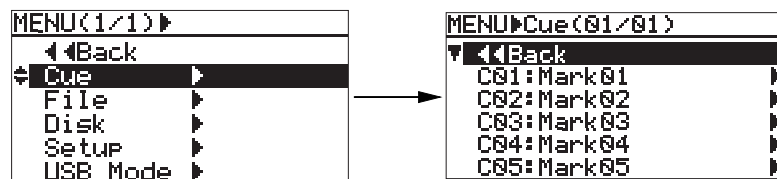

In the screen example above, five cue points are stored with the default cue names. Up to five cue points can be shown on a single page. If more than five cue points are stored, the list screen has more than one page.

At the upper right of the screen, you can see the current page and the total page number. If "(01/02)" is shown, the cue point list has 2 pages and the display currently shows page 1).

When the cue point list is shown, you can see the time data of each cue point by pressing and holding down the [SHIFT] key. Releasing the [SHIFT] key returns the screen to show the file name.

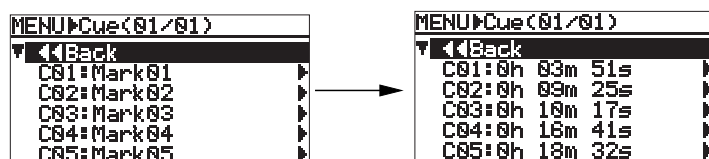

- 2) Use the [MENU] dial to select a desired cue point and press the [ENTER] key.

The display now shows the Cue menu. (In the screen example above, "C01:Mark01" is selected.)

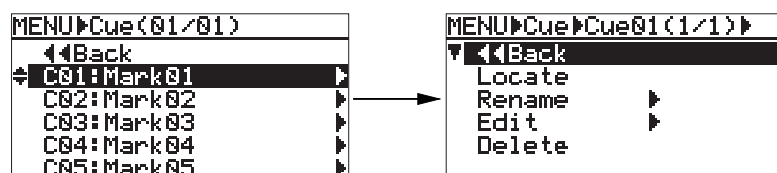

- 3) Use the [MENU] dial to select "Locate" and press the [ENTER] key.

The display now shows the screen as below, and the recorder immediately locates to the selected cue point. When the locate operation is completed, "Completed!" is shown on the screen, and then the display returns to the Home screen.

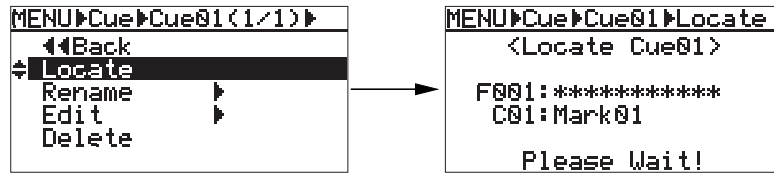

"F001": Current file name
 "C01": Current cue number and cue name

When a USB keyboard is connected to the FR-2, you can carry out the following operation.

↑/↓ key	Acts the same as the [MENU] dial on the FR-2 panel.
< key	Returns to the previous screen layer.
Enter key	Acts the same as the [ENTER] key on the FR-2 panel.

Renaming a cue point (Rename)

The following description is assumed that the FR-2 is now in the MENU mode by pressing the [ENTER] key while the recorder is stopped.

- 1) Use the [MENU] dial to select "Cue" and press the [ENTER] key.

The display now shows the cue point list in which all cue points stored in the current file are shown.

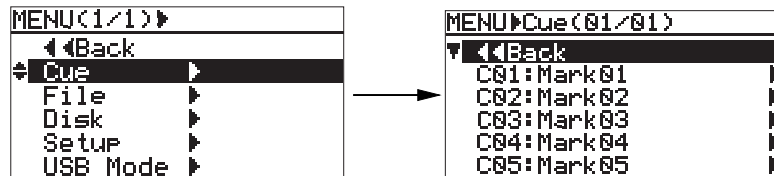

- 2) Use the [MENU] dial to select a desired cue point and press the [ENTER] key.

The display now shows the Cue menu. (In the screen example above, "C01:Mark01" is selected.)

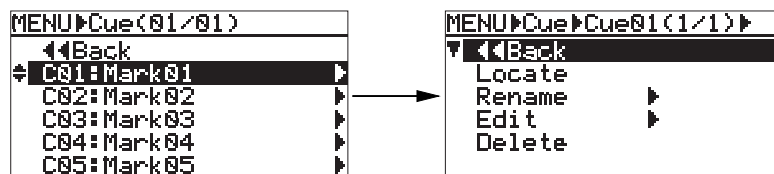

- 3) Use the [MENU] dial to select "Rename" and press the [ENTER] key.

The display now shows the screen as below, on which you can edit the cue name.

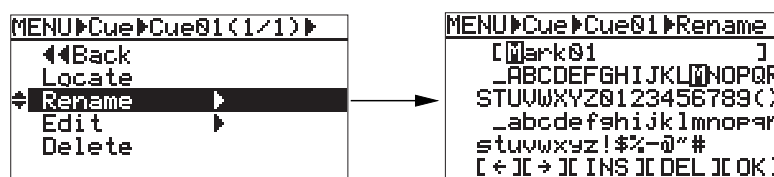

The cursor in [] is called "cue name cursor", while the cursor in the character options is called "character selection cursor".

You can move the character selection cursor by using the [MENU] dial.

4) Enter the desired cue name.

See the table below for details about how to enter a name. Up to 32 characters can be entered.

To edit a character highlighted (on the cursor position)	Use the [MENU] dial to select a desired character from among the character options, and press the [ENTER] key. The selection is fixed and the cue name cursor moves right.
To move the cue name cursor position	Use [←] or [→] key. Or use the [MENU] dial to select "<" or ">" in the character options, and press the [ENTER] key.
Inserts a front space at the cue name cursor position	After moving the cue name cursor to the desired position, move the character selection cursor to "INS" at the bottom, and press the [ENTER] key. (The FR-2 is put into the INSERT mode and the cue name cursor condition changes to be lit solid.) After that, select the character that you would like to insert by the character selection cursor and press the [ENTER] key again. In order to cancel the INSERT mode, select the "INS" and then the [ENTER] key. (The cue name cursor condition changes to be flashing.)
To delete a character on the cue name cursor position	After moving the cue name cursor to the desired position, move the character selection cursor to "DEL" at the bottom, and press the [ENTER] key.

5) Move the character selection cursor to "OK", and press the [ENTER] key.

The FR-2 starts the operation for storing the entered name. When completed, "Completed!" is shown on the screen and the display returns to the cue point list screen as shown below.

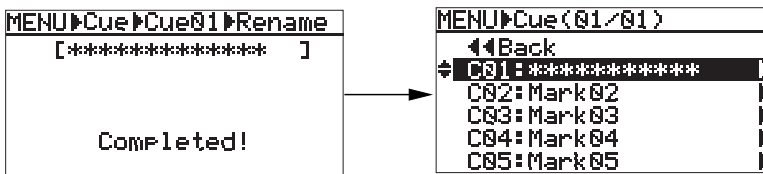

You can enter up to 32 characters, however, only 16 characters can be displayed. If a name has more than 16 characters, "->" is shown on the right of [].

6) Press the [HOME] key to exit the MENU mode.

When a USB keyboard is connected to the FR-2, you can carry out the following operation.

Character/numeric keys	You can directly enter a character instead of selecting from among the character options on the screen. Each time you press a character key, the cue name cursor moves right.
↑ / ↓ key	Acts the same as the [MENU] dial on the FR-2 panel.
← / → key	Moves the cue name cursor right and left.
Back space key	Deletes the character at the cue name cursor position, and slides all the subsequent characters left.
Insert key	Turn ON and OFF the INSERT mode. When it is ON, the cue name cursor is lit solid. When it is OFF, the cue name cursor is flashing.
Delete key	Deletes the character at the cue name cursor position.
Enter key	Used to fix the name entered. Acts the same as moving the character selection cursor to "OK" and pressing the [ENTER] key on the FR-2 panel.

Editing time data of a cue point (Edit)

The following description is assumed that the FR-2 is now in the MENU mode by pressing the [ENTER] key while the recorder is stopped.

- 1) Use the [MENU] dial to select "Cue" and press the [ENTER] key.

The display now shows the cue point list in which all cue points stored in the current file are shown.

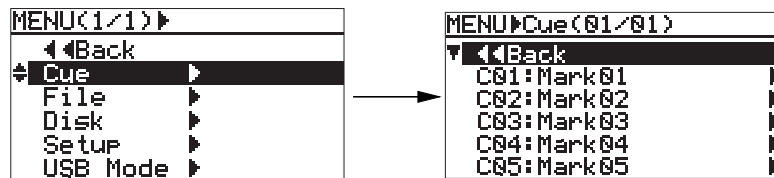

- 2) Use the [MENU] dial to select a desired cue point and press the [ENTER] key.

The display now shows the Cue menu. In the screen example above, "C01:Mark01" is selected.

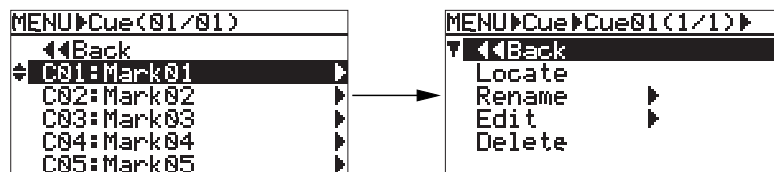

- 3) Use the [MENU] dial to select "Edit" and press the [ENTER] key.

The display now shows the screen as below, on which you can edit time data of the cue point (initially, the minute field flashes).

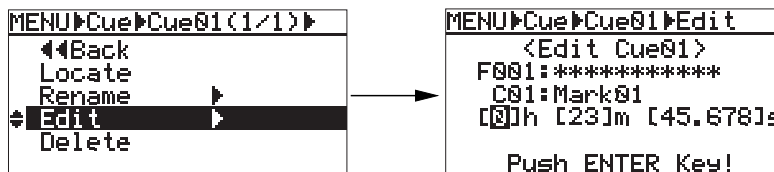

- 4) Use the [MENU] dial to enter the desired value in the hour field and press the [ENTER] key.

The value is fixed and the cursor moves to the left part of the decimal point in the minute field.

- 5) Use the [MENU] dial to enter the desired value in the minute field and press the [ENTER] key.

The value is fixed and the cursor moves to the left part of the decimal point in the second field.

- 6) Use the [MENU] dial to enter the desired value at the left part of the decimal point in the second field and press the [ENTER] key.

The value is fixed and the cursor moves to the right part of the decimal point in the second field.

- 7) Use the [MENU] dial to enter the desired value at the right part of the decimal point in the second field and press the [ENTER] key.

The FR-2 starts the operation for storing the edited time data. When completed, "Completed!" is shown on the screen and the display returns to show the Home screen.

<Note>: Depending on time data to be stored, the cue number may be changed. In the example above, the entered time data is stored to Cue 03.

<Note>: If you are going to store illegal time data, "Illegal time!" flashes on the display and you cannot store the time.

When a USB keyboard is connected to the FR-2, you can carry out the following operation.

↑/↓ key	Acts the same as the [MENU] dial on the FR-2 panel.
← key	Returns to the previous screen layer.
Enter key	Acts the same as the [ENTER] key on the FR-2 panel.
Numeric keys	You can directly enter time data.

Deleting a cue point (Delete)

The following description is assumed that the FR-2 is now in the MENU mode by pressing the [ENTER] key while the recorder is stopped.

- 1) Use the [MENU] dial to select "Cue" and press the [ENTER] key.

The display now shows the cue point list in which all cue points stored in the current file are shown.

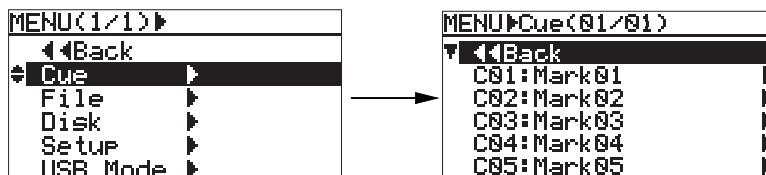

- 2) Use the [MENU] dial to select a desired cue point and press the [ENTER] key.

The display now shows the Cue menu. In the screen example above, "C01:Mark01" is selected.

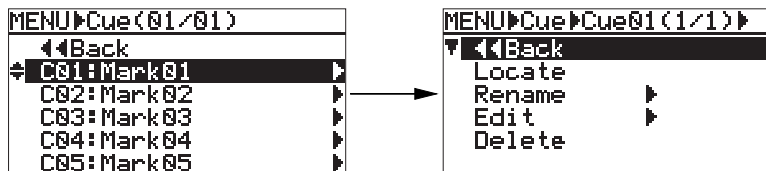

- 3) Use the [MENU] dial to select "Delete" and press the [ENTER] key.

The FR-2 starts deleting the selected cue point. When completed, "Completed!" is shown on the screen and the display shows the Home screen, on which you can see the number of cue points decreases by one.

If you switch to the cue point list screen, you can see "Mark01" has been deleted, while "Mark02" and subsequent cue points slide up, as shown in the screen example below.

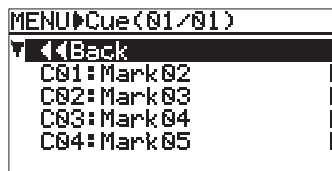

When a USB keyboard is connected to the FR-2, you can carry out the following operation.

↑/↓ key	Acts the same as the [MENU] dial on the FR-2 panel.
← key	Returns to the previous screen layer.
Enter key	Acts the same as the [ENTER] key on the FR-2 panel.

File menu

The File menu offers the following five menu items regarding existing audio files.

- * **Select:** Selecting an audio file to be played back
- * **Rename:** Renaming an audio file
- * **Delete:** Deleting an unnecessary audio file
- * **Protect:** Select audio file protection on/off
- * **Restore:** Restoring a deleted (hidden) audio file

<Note>: To carry out operations of File menu items, one or more audio files must be stored to the current memory card.

Selecting an audio file to be played back (Select)

The following description is assumed that the FR-2 is now in the MENU mode by pressing the [ENTER] key while the recorder is stopped.

- 1) Use the [MENU] dial to select "File" and press the [ENTER] key.

The display now shows the audio file list in which all recorded audio files on the current card are shown (in the screen example below, each file name is shown as something like "*****").

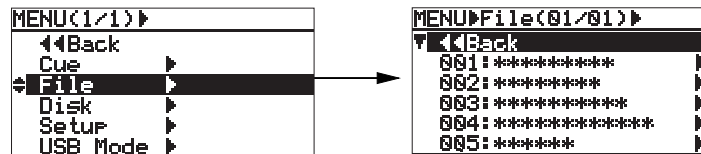

In the screen example above, you can see five audio files are stored. Up to five audio files can be shown on a single page. If more than five audio files are stored, the list screen has more than one page. At the top of the screen, you can see the current page and the total page number. If "(01/02)" is shown, the audio file list has 2 pages and the display currently shows page 1).

- 2) Use the [MENU] dial to select a desired audio file and press the [ENTER] key.

The display now shows the File menu. In the screen example above, file "003" is selected.

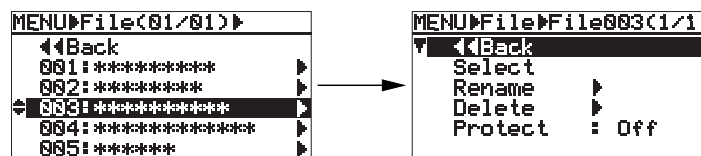

- 3) Use the [MENU] dial to select "Select" and press the [ENTER] key.

The display now shows the screen as shown in the middle below and the recorder starts loading the file. When the operation is completed, the display shows the Home screen of the selected audio file.



When a USB keyboard is connected to the FR-2, you can carry out the following operation.

↑/↓ key	Acts the same as the [MENU] dial on the FR-2 panel.
← key	Returns to the previous screen layer.
Enter key	Acts the same as the [ENTER] key on the FR-2 panel.

Renaming an audio file (Rename)

The following description is assumed that the FR-2 is now in the MENU mode by pressing the [ENTER] key while the recorder is stopped.

- 1) Use the [MENU] dial to select "File" and press the [ENTER] key.

The display now shows the audio file list in which all recorded audio files on the current card are shown.

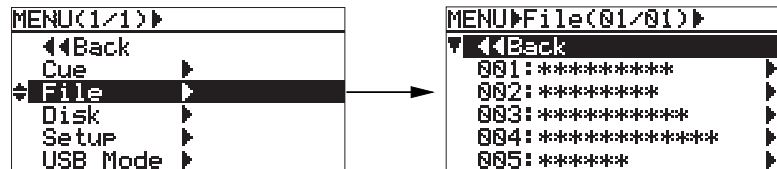

- 2) Use the [MENU] dial to select a desired audio file and press the [ENTER] key.

The display now shows the File menu. In the screen example above, file "004" is selected.

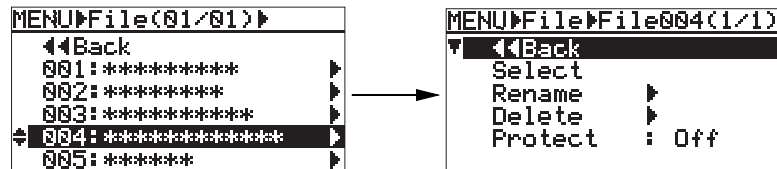

- 3) Use the [MENU] dial to select "Rename" and press the [ENTER] key.

The display now shows the screen as below, on which you can edit the file name.

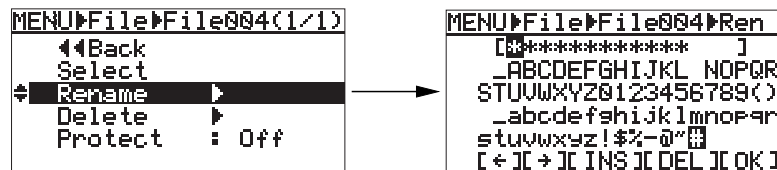

The cursor in [] is called "file name cursor", while the cursor in the character options is called "character selection cursor". You can move the character selection cursor by using the [MENU] dial.

- 4) Enter the desired file name.

See the table below for details about how to enter a name. Up to 32 characters can be entered.

To edit a character highlighted (on the cursor position)	Use the [MENU] dial to select a desired character from among the character options, and press the [ENTER] key. The selection is fixed and the file name cursor moves right.
To move the file name cursor position	Use [<<] or [>>] key. Or use the [MENU] dial to select " < " or " > " in the character options, and press the [ENTER] key.
Inserts a front space at the file name cursor position	After moving the file name cursor to the desired position, move the character selection cursor to "INS" at the bottom, and press the [ENTER] key. (The FR-2 is put into the INSERT mode and the file name cursor condition changes to be lit solid.) After that, select the character that you would like to insert by the character selection cursor and press the [ENTER] key again. In order to cancel the INSERT mode, select the "INS" and then the [ENTER] key. (The file name cursor condition changes to be flashing.)
To delete a character on the file name cursor position	After moving the file name cursor to the desired position, move the character selection cursor to "DEL" at the bottom, and press the [ENTER] key.

- 5) **Move the character selection cursor to "OK" and press the [ENTER] key.**
 The FR-2 starts the operation for storing the entered name. When completed, "Completed!" is shown on the screen and the display returns to show the audio file list screen as below.

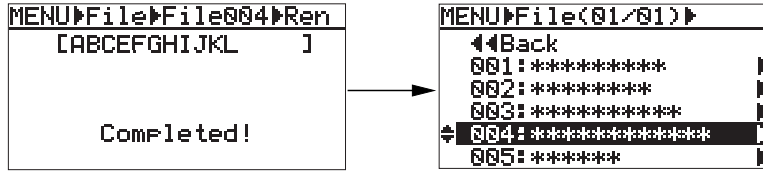

You can enter up to 32 characters, however, only 16 characters can be displayed. If a name has more than 16 characters, "->" is shown on the right of [].

<Note>: If you are going to store a name which already exists on the file, "Same name exist!" flashes on the display and you cannot store the name.
 If you are going to store an illegal name, "Illegal name!" flashes on the display and the operation is canceled.

- 6) **Press the [HOME] key to exit the MENU mode.**

When a USB keyboard is connected to the FR-2, you can carry out the following operation.

Character keys	You can directly enter a character instead of selecting from among the character options on the screen. Each time you press a character key, the file name cursor moves right.
↑/↓ keys	Acts the same as the [MENU] dial on the FR-2 panel.
</> keys	Moves the file name cursor right and left.
Back space key	Deletes the character at the file name cursor position, and slides all the subsequent characters left.
Insert key	Turn ON and OFF the INSERT mode. When it is ON, the file name cursor is lit solid. When it is OFF, the file name cursor is flashing.
Delete key	Deletes the character at the file name cursor position.
Enter key	Used to fix the name entered. Acts the same as moving the character selection cursor to "OK" and pressing the [ENTER] key on the FR-2 panel.

Deleting an audio file (Delete)

The following description is assumed that the FR-2 is now in the MENU mode by pressing the [ENTER] key while the recorder is stopped.

- 1) **Use the [MENU] dial to select "File" and press the [ENTER] key.**
 The display now shows the audio file list in which all recorded audio files on the current card are shown. If more than five audio files are stored, the list screen has more than one page.

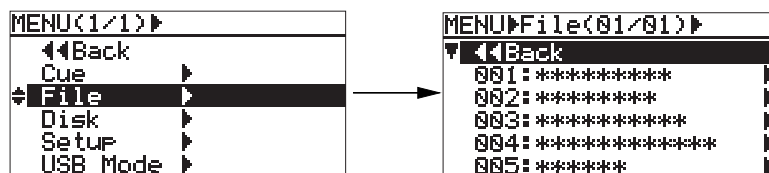

- 2) Use the [MENU] dial to select a desired audio file and press the [ENTER] key.

The display now shows the File menu. In the screen example above, file "003" is selected.

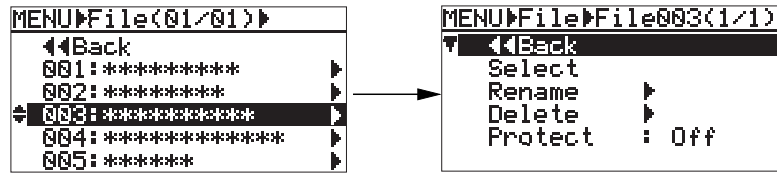

- 3) Use the [MENU] dial to select "Delete" and press the [ENTER] key.

The display now shows the screen as below. "Sure?" lites, asking you whether you are sure to delete the selected file.

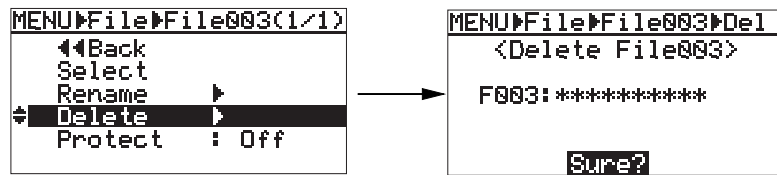

To cancel the operation for deleting the file, press the [HOME] key to exit the MENU mode.

- 4) Press the [ENTER] key to delete the file.

The FR-2 starts the operation for deleting the audio file. When completed, "Completed!" is shown on the screen and the display returns to show the audio file list. In the file name field of the deleted file, "[0]" is shown.

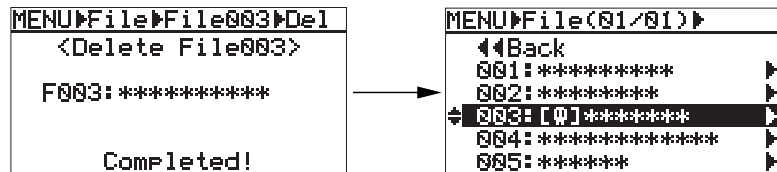

- 5) Press the [HOME] key to exit the MENU mode.

The display changes to show the Home screen of the next file to the deleted file.

<Note>: The deleted audio file still exists on the memory card as a "hidden file". You can restore a hidden file as the same file as before. See "Restoring a deleted audio file" for details. When a card is optimized, hidden files are completely deleted. See "Optimizing a memory card" on page 75 for details about optimizing a card.

When a USB keyboard is connected to the FR-2, you can carry out the following operation.

↑/↓ key	Acts the same as the [MENU] dial on the FR-2 panel.
← key	Returns to the previous screen layer.
Enter key	Acts the same as the [ENTER] key on the FR-2 panel.

Audio file protection on/off (Protect)

The following description is assumed that the FR-2 is now in the MENU mode by pressing the [ENTER] key while the recorder is stopped.

- 1) Use the [MENU] dial to select "File" and press the [ENTER] key.

The display now shows the audio file list in which all recorded audio files on the current card are shown. If more than five audio files are stored, the list screen has more than one page.

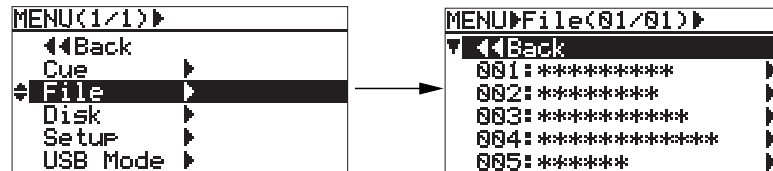

- 2) Use the [MENU] dial to select a desired audio file and press the [ENTER] key.

The display now shows the File menu. In the screen example above, file "003" is selected.

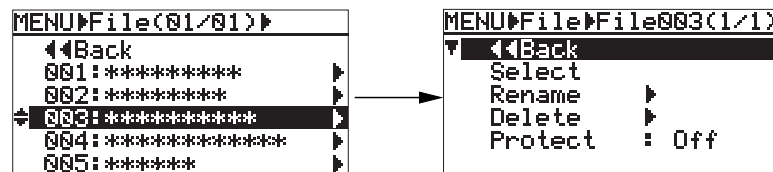

- 3) Use the [MENU] dial to select "Protect" and press the [ENTER] key.

The current protect setting (by default, "Off") starts flashing.

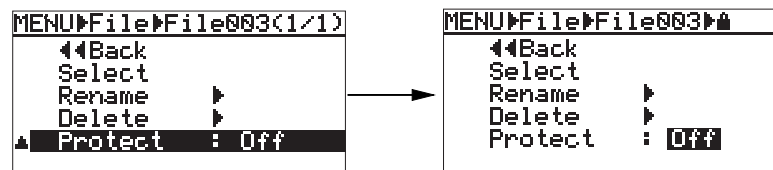

- 4) Use the [MENU] dial to select the desired option ("ON" or "OFF") and press the [ENTER] key.

The selection is fixed and the display returns to the File menu.

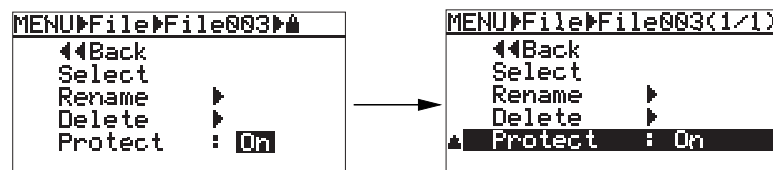

- 5) Press the [HOME] key to exit the MENU mode.

On the Home screen of a protected file, "🔒" is shown at the end of the file name, indicating that the file is protected.

<Note>: You cannot make any editing operation, as well as delete a protected file.

When a USB keyboard is connected to the FR-2, you can carry out the following operation.

↑/↓ key	Acts the same as the [MENU] dial on the FR-2 panel.
← key	Returns to the previous screen layer.
Enter key	Acts the same as the [ENTER] key on the FR-2 panel.

Restoring an audio file (Restore)

The following description is assumed that the FR-2 is now in the MENU mode by pressing the [ENTER] key while the recorder is stopped.

<Note>: If you optimize a card which has any hidden files, they are completely deleted and cannot be restored anymore.

- 1) Use the [MENU] dial to select "File" and press the [ENTER] key.

The display now shows the audio file list in which all recorded audio files on the current card are shown. In the screen example below, file 003 is a hidden file.

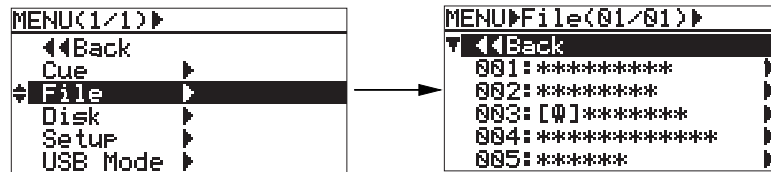

- 2) Use the [MENU] dial to select a hidden file you wish to restore and press the [ENTER] key.

The display now shows the screen as below right.

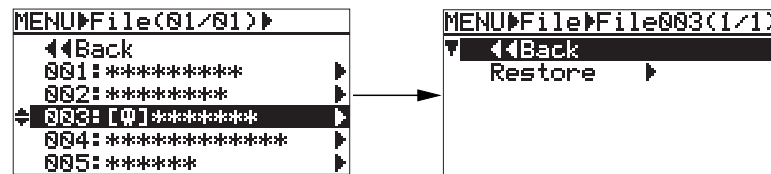

- 3) Use the [MENU] dial to select "Restore" and press the [ENTER] key.

The FR-2 starts the operation for restoring the file. When completed, "Completed!" is shown on the screen and the display returns to show the audio file list (in the screen example below, you can see file 003 is restored).



- 4) Press the [HOME] key to exit the MENU mode.

When a USB keyboard is connected to the FR-2, you can carry out the following operation.

↑/↓ key	Acts the same as the [MENU] dial on the FR-2 panel.
← key	Returns to the previous screen layer.
Enter key	Acts the same as the [ENTER] key on the FR-2 panel.

Disk menu

The Disk menu offers the following five menu items.

- * **Select:** Selecting the current memory card
- * **Optimize:** Optimizing a memory card
- * **Format:** Formatting a memory card
- * **Volume Label:** Editing a volume label of a memory card
- * **Disk Info.:** Viewing information of a memory card

<Note>: To carry out operations of Disk menu items, at least one memory card must be set to the current audio file.

Selecting the current drive (Select)

This menu item selects the current drive.

When a memory card is inserted to the associated slot and the power is supplied to the drive, the FR-2 automatically selects the drive as the current drive.

However, for example, if both CFC and ATA CF cards are inserted to the respective slots when turning on the FR-2, you have to select the current drive by the following procedure. The following description is assumed that the FR-2 is now in the MENU mode by pressing the [ENTER] key while the recorder is stopped.

- 1) Use the [MENU] dial to select "Disk" and press the [ENTER] key.

The display now shows the Disk menu.

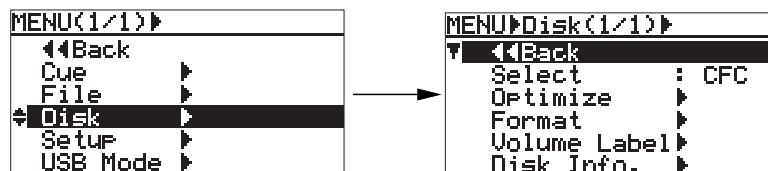

- 2) Use the [MENU] dial to select "Select" and press the [ENTER] key.

The current drive name ("CFC" or "PCMCIA") which is automatically detected starts flashing.

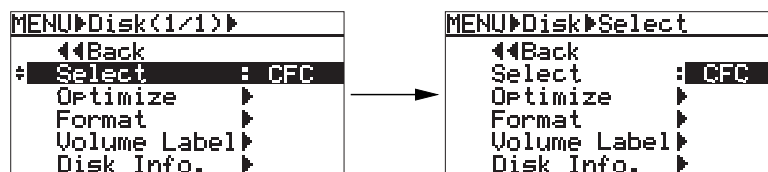

- 3) Use the [MENU] dial to select the desired drive (or "Off") and press the [ENTER] key.

When both CFC and PCMCIA cards are already inserted to the respective slots, you can select from among the following options.

Pressing the [ENTER] key fixes selection and the display returns to show the Disk menu.

Off	Both the PCMCIA and CFC drives are disabled (no memory card is selected).
CFC	The PCMCIA drive is selected. The CFC drive is disabled (released).
PCMCIA	The CFC drive is selected. The PCMCIA drive is disabled (released).

- 4) Press the [HOME] key to exit the MENU mode.

When a USB keyboard is connected to the FR-2, you can carry out the following operation.

↑/↓ keys	Acts the same as the [MENU] dial on the FR-2 panel.
← key	Returns to the previous screen layer.
Enter key	Acts the same as the [ENTER] key on the FR-2 panel.

Optimizing a memory card (Optimize)

You can optimize a memory card.
 By optimizing a recorded memory card, any hidden audio files are completely deleted, increasing free block space (free space) on the memory card.
 The following description is assumed that the FR-2 is now in the MENU mode by pressing the [ENTER] key while the recorder is stopped.

<Note>: If you optimize a memory card which has any hidden files, you cannot restore the hidden files any more.

- 1) Use the [MENU] dial to select "Disk" and press the [ENTER] key.
 The display now shows the Disk menu.

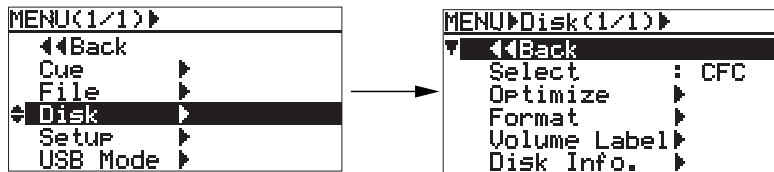

- 2) Use the [MENU] dial to select "Optimize" and press the [ENTER] key.
 The display shows the following caution message, in which "Are you sure?" flashes.

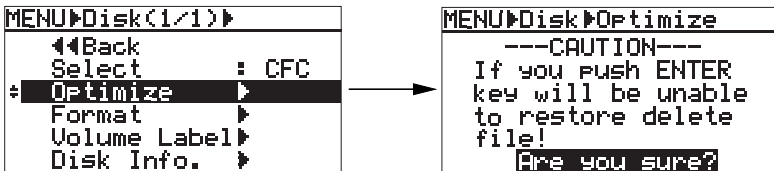

- 3) Press the [ENTER] key.
 The FR-2 starts optimizing the card and "Please Wait!" is shown on the display. When completed, the display shows "Completed!" and then returns to the Home screen.

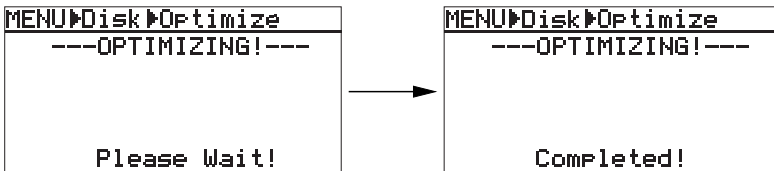

When a USB keyboard is connected to the FR-2, you can carry out the following operation.

↑/↓ keys	Acts the same as the [MENU] dial on the FR-2 panel.
← key	Returns to the previous screen layer.
Enter key	Acts the same as the [ENTER] key on the FR-2 panel.

Formatting a memory card (Format)

The FR-2 can format the current memory card with the FAT32 (File Allocation Table 32) file system. The following description is assumed that the FR-2 is now in the MENU mode by pressing the [ENTER] key while the recorder is stopped.

- 1) Use the [MENU] dial to select "Disk" and press the [ENTER] key.

The display now shows the Disk menu.

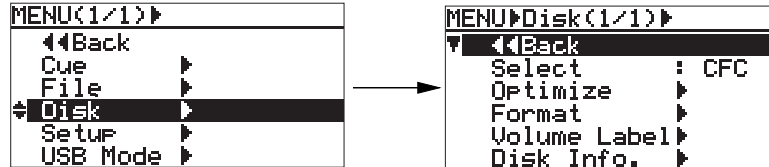

- 2) Use the [MENU] dial to select "Format" and press the [ENTER] key.

The display shows the following caution message, in which "Are you sure?" flashes.

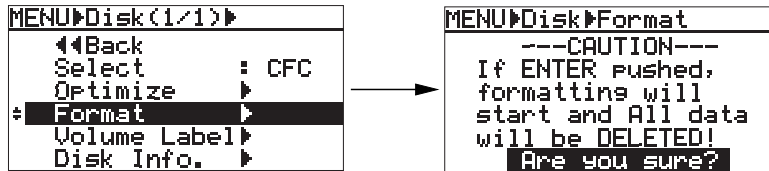

- 3) Press the [ENTER] key.

The FR-2 starts formatting the card and "Please Wait!" is shown on the display. When completed, the display shows "Completed!" and then returns to the Home screen.

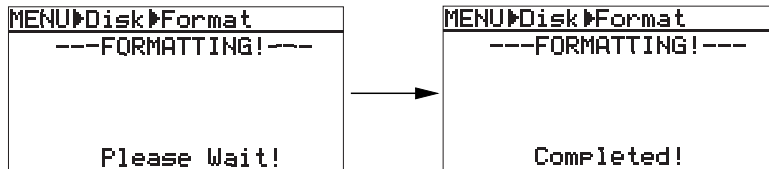

<Note>: The default volume label of a memory card, which is automatically given when the card is formatted, is as below.

PCMCIA: "PCM000"
CFC: "CFC000"

When a USB keyboard is connected to the FR-2, you can carry out the following operation.

↑/↓ keys	Acts the same as the [MENU] dial on the FR-2 panel.
← key	Returns to the previous screen layer.
Enter key	Acts the same as the [ENTER] key on the FR-2 panel.

Editing a volume label of a memory card (Volume Label)

When a memory card is formatted, the default volume label is automatically given. You can edit this volume label to the desired one.

The following description is assumed that the FR-2 is now in the MENU mode by pressing the [ENTER] key while the recorder is stopped.

1) Use the [MENU] dial to select "Disk" and press the [ENTER] key.

The display now shows the Disk menu.

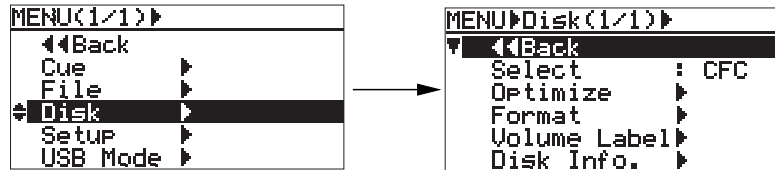

2) Use the [MENU] dial to select "Volume Label" and press the [ENTER] key.

The display now shows the screen as below, on which you can edit the volume label of the currently selected memory card. In the screen example below, the default volume label is "PCM000".

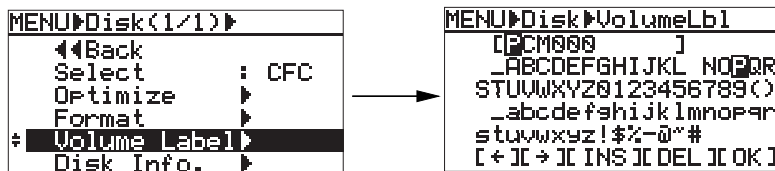

The cursor in [] is called "volume label cursor", while the cursor in the character options is called "character selection cursor".

You can move the character selection cursor by using the [MENU] dial.

3) Enter the desired volume label.

See the table below for details about how to enter a volume label. Up to 11 characters can be entered.

To edit a character highlighted (on the cursor position)	Use the [MENU] dial to select a desired character from among the character options, and press the [ENTER] key. The selection is fixed and the volume label cursor moves right.
To move the volume label cursor position	Use [←] or [→] key. Or use the [MENU] dial to select "<" or ">" in the character options, and press the [ENTER] key.
Inserts a front space at the volume label cursor position	After moving the volume label cursor to the desired position, move the character selection cursor to "INS" at the bottom, and press the [ENTER] key. (The FR-2 is put into the INSERT mode and the volume label cursor condition changes to be lit solid.) After that, select the character that you would like to insert by the character selection cursor and press the [ENTER] key again. In order to cancel the INSERT mode, select the "INS" and then the [ENTER] key. (The volume label cursor condition changes to be flashing.)
To delete a character on the volume label cursor position	After moving the volume label cursor to the desired position, move the character selection cursor to "DEL" at the bottom, and press the [ENTER] key.

4) **Move the character selection cursor to "OK" and press the [ENTER] key.**

The display shows "Please Wait!" while the FR-2 is executing the operation for storing the entered label. When the operation is completed, "Completed!" is shown on the screen and the display returns to show the Home screen.

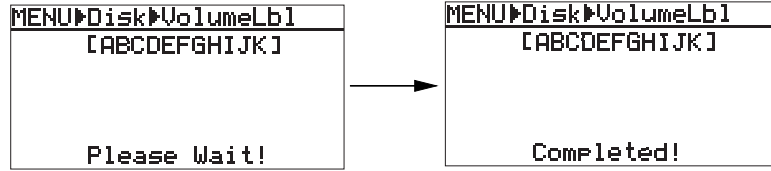

You can enter up to 11 characters. If you enter more than 11 characters, the FR-2 automatically deletes characters after the 12th.

<Note>: If you are going to enter an illegal name, "Illegal!" is shown on the display and the operation is cancelled.

When a USB keyboard is connected to the FR-2, you can carry out the following operation.

Character keys	You can directly enter a character instead of selecting from among the character options on the screen. Each time you press a character key, the volume label cursor moves right.
↑ / ↓ keys	Acts the same as the [MENU] dial on the FR-2 panel.
← / → keys	Moves the volume label cursor right and left.
Back space key	Deletes the character at the volume label cursor position, and moves all the subsequent characters left.
Insert key	Turn ON and OFF the INSERT mode. When it is ON, the volume label cursor is lit solid. When it is OFF, the file name cursor is flashing.
Delete key	Deletes the character at the volume label cursor position.
Enter key	Used to fix the label entered. Acts the same as moving the character selection cursor to "OK" and pressing the [ENTER] key on the FR-2 panel.

Viewing information of a memory card (Disk Info.)

You can view information of the current memory card.
 The following description is assumed that the FR-2 is now in the MENU mode by pressing the [ENTER] key while the recorder is stopped.

- 1) Use the [MENU] dial to select "Disk" and press the [ENTER] key.
 The display now shows the Disk menu.

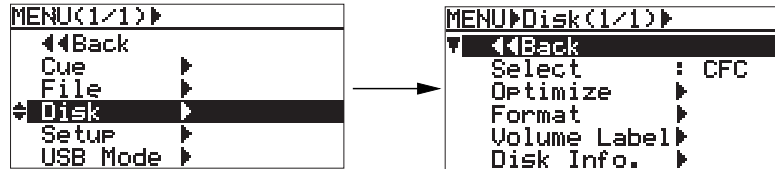

- 2) Use the [MENU] dial to select "Disk Info." and press the [ENTER] key.
 The information of the current memory card is shown as below.

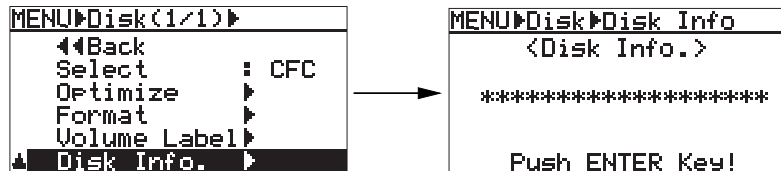

- 3) To dismiss the information, press the [ENTER] key.
 The display returns to the previous screen (Disk menu).
- 4) Press the [HOME] key to exit the MENU mode.

When a USB keyboard is connected to the FR-2, you can carry out the following operation.

↑/↓ key	Acts the same as the [MENU] dial on the FR-2 panel.
← key	Returns to the previous screen layer.
Enter key	Acts the same as the [ENTER] key on the FR-2 panel.

Setup menu

The Setup menu offers the following thirteen menu items which mainly set preferences of the FR-2.

- * **File Name Mode:** Selecting default file name type
- * **Default File Name:** Setting the default file name and take number
- * **Adjust Real Time Clock:** Adjusting the real time clock
- * **Speaker Mute:** Speaker mute function on/off
- * **Error Tone:** Setting error tone output condition
- * **Peak Hold Time:** Setting the peak hold time of the level meters
- * **Pre Rec Time:** Setting the time length of audio stored in the buffer
- * **Remain Display:** Selecting the remain display mode
- * **Digi Out Type:** Setting the digital output signal format
- * **Battery:** Selecting the battery type
- * **Keyboard:** Selecting the USB keyboard type
- * **Version:** Viewing the ROM version
- * **Init Setup:** Initializing settings of the Setup menu

The Setup menu screen has the following three pages.

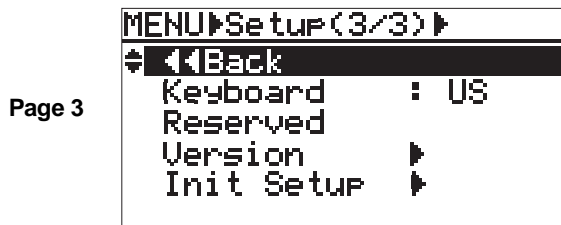
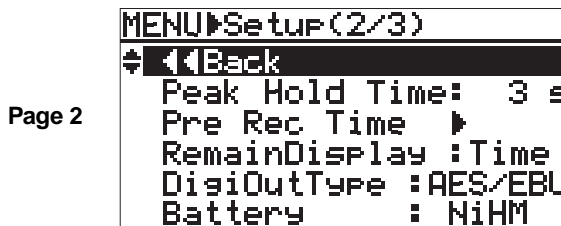
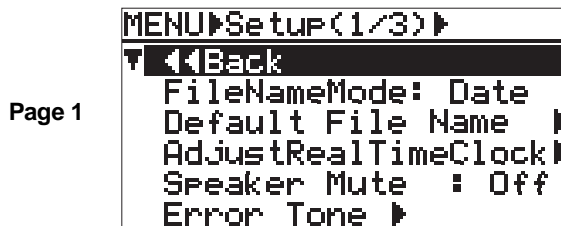

Selecting default file name type (File Name Mode)

Each time recording is made, an audio file is created with a specific "default" file name which is automatically given.

This menu item selects the default file name type between the "time and date" information when a file is created and "scene name + take number".

The following description is assumed that the FR-2 is now in the MENU mode by pressing the [ENTER] key while the recorder is stopped.

- 1) Use the [MENU] dial to select "Setup" and press the [ENTER] key.

The display now shows the Setup menu screen.

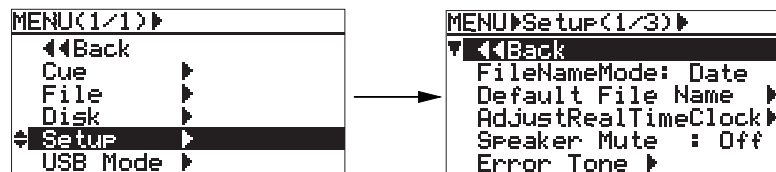

- 2) Use the [MENU] dial to select "FileNameMode" and press the [ENTER] key.

The current file name mode flashes (by default, "Date" flashes).

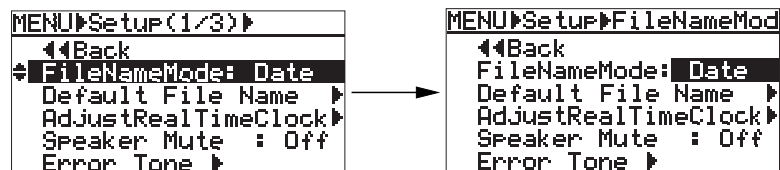

- 3) Use the [MENU] dial to select the desired file mode and press the [ENTER] key.

You can select the file name mode between "Date" and "Take".

Date	A file name contains time/date information of the realtime clock when the audio file is created. For example, if a file is created at 12:30:25 on December 25 in 2003, the file name is "B12h30m25s25dec2003y".
Take	A file name contains the desired scene name and take number. For example, if you set the scene name to "Original Name" and take number to "001", the file name is "Original Name_001".

* Up to 15 characters are shown on the display.

Pressing the [ENTER] key fixes the selection and the display shows the previous screen.

- 4) Press the [HOME] key to exit the MENU mode.

When a USB keyboard is connected to the FR-2, you can carry out the following operation.

↑/↓ keys	Acts the same as the [MENU] dial on the FR-2 panel.
← key	Returns to the previous screen layer.
Enter key	Acts the same as the [ENTER] key on the FR-2 panel.

Setting the default file name (Default File Name)

This menu item sets the default scene name and take number used for a file name. The "Default scene name" setting is effective when the "File Name Mode" described above is set to "Scene".

The following description is assumed that the FR-2 is now in the MENU mode by pressing the [ENTER] key while the recorder is stopped.

- 1) Use the [MENU] dial to select "Setup" and press the [ENTER] key.

The display now shows the Setup menu.

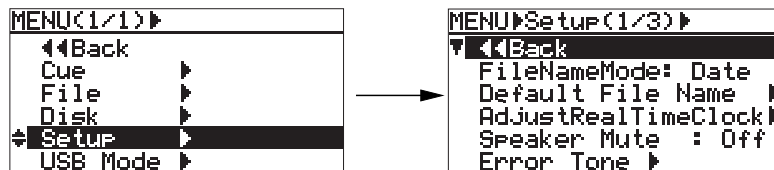

- 2) Use the [MENU] dial to select "Default Scene Name" and press the [ENTER] key.

The display now shows the scene name list for selecting a desired scene name. The scene name list has 17 pages.

You can select a desired option from among "Scene01" through "Scene99".

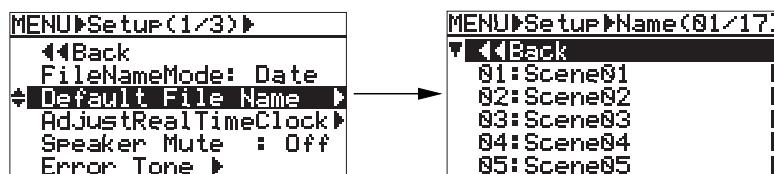

- 3) Use the [MENU] dial to select a desired scene name and press the [ENTER] key.

The display now shows the setting items for the selected scene name.

For example, if you select "01: Scene01", the screen looks like the one shown right below.

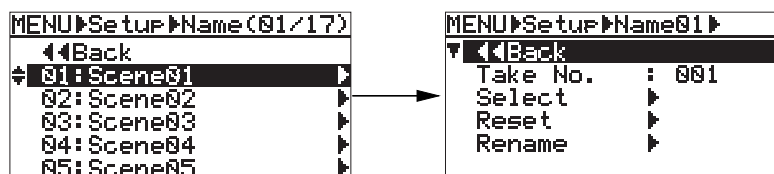

The function of each parameter is as below.

Take No.	Selects the take number (001 through 999).
Select	Enables the selected scene name.
Reset	Sets the selected scene name to the default name (such as "Scene01").
Rename	Renames the scene name to a new one.

The following procedure shows how to select scene name 01 (Scene01), set the desired scene name and Take number, and enable the setting.

• **Selecting Take number**

- 1) **Select "Take No." and press the [ENTER] key.**

The current Take number starts flashing (by default, "001" flashes).

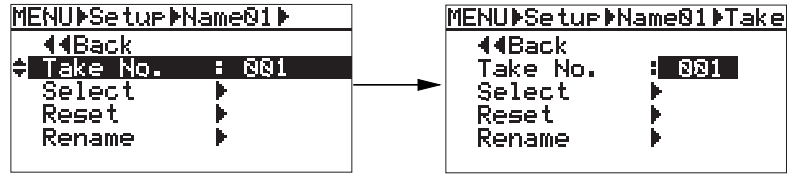

- 2) **Use the [MENU] dial to select the desired Take number and press the [ENTER] key.**

You can select a Take number between 001 and 999.

Pressing the [ENTER] key fixes the selection and the display returns to the previous screen.

• **Renaming the scene name**

- 1) **Select "Rename" and press the [ENTER] key.**

The display now shows the screen on which you can edit the selected scene name (Scene01).

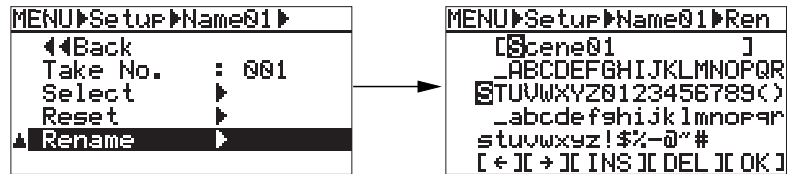

The cursor in [] is called "scene name cursor", while the cursor in the character options is called "character selection cursor".

You can move the character selection cursor by using the [MENU] dial.

- 2) **Enter the desired scene name.**

See the table below for details about how to enter a name. Up to 15 characters can be entered.

To edit a character highlighted (on the cursor position)	Use the [MENU] dial to select a desired character from among the character options, and press the [ENTER] key. The selection is fixed and the scene name cursor moves right.
To move the scene name cursor position	Use [l<<] or [>>] key. Or use the [MENU] dial to select "<" or ">" in the character options, and press the [ENTER] key.
Inserts a front space at the scene name cursor position	After moving the scene name cursor to the desired position, move the character selection cursor to "INS" at the bottom, and press the [ENTER] key. (The FR-2 is put into the INSERT mode and the scene name cursor condition changes to be lit solid.) After that, select the character that you would like to insert by the character selection cursor and press the [ENTER] key again. In order to cancel the INSERT mode, select the "INS" and then the [ENTER] key. (The scene name cursor condition changes to be flashing.)
To delete a character on the scene name cursor position	After moving the scene name cursor to the desired position, move the character selection cursor to "DEL" at the bottom, and press the [ENTER] key.

- 3) **Move the character selection cursor to "OK" and press the [ENTER] key.**

After the FR-2 stores the entered name immediately, "Completed!" is shown on the screen and the display returns to show the scene name list screen.

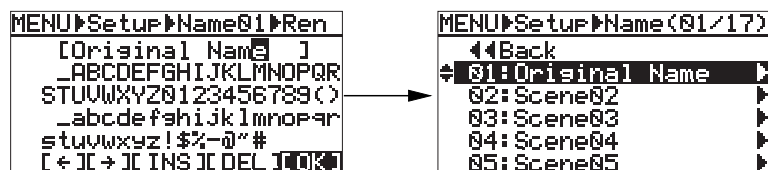

When a USB keyboard is connected to the FR-2, you can carry out the following operation.

Character keys	You can directly enter a character instead of selecting from among the character options on the screen. Each time you press a character key, the scene name cursor moves right.
↑/↓ keys	Acts the same as the [MENU] dial on the FR-2 panel.
← / → keys	Moves the scene name cursor right and left.
Back space key	Deletes the character at the scene name cursor position.
Insert key	Turn ON and OFF the INSERT mode. When it is ON, the scene name cursor is lit solid. When it is OFF, the file name cursor is flashing.
Delete key	Deletes the character at the scene name cursor position.
Enter key	Used to fix the scene name entered.

• Enabling the selected scene name

- 1) **Press the [ENTER] key.**

The display now shows the setting items for the selected scene name.

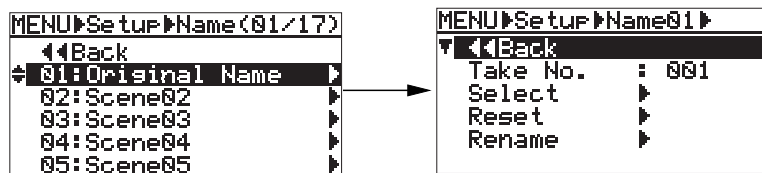

- 2) **Select "Select" and press the [ENTER] key.**

After showing "Completed!", the display returns to show the setting items.

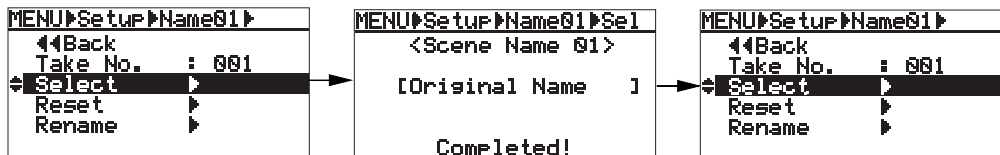

- 3) **Press the [HOME] key to exit the MENU mode.**

For example, if you set the scene name of "Scene01" to "Original Name" and the take number to "001", the default scene name is "Original Name_001". In this condition, if you make recording while the "File Name Mode" is set to "Scene01", a file named "Original Name_001" is created. If you make recording again in this condition, a file named "Original Name_002" is created. Thus, each time you make recording, the take number is counted up.

• Resetting the scene name to the initial name

- 1) **Select a desired scene name you want to reset, and press the [ENTER] key.**

The display now shows the setting items for the selected scene name.

- 2) **Select "Reset" and press the [ENTER] key.**

The selected scene name is immediately reset to the initial name. For example, if you reset the scene name above ("Original Name"), the scene name returns to "Scene01".

- 3) **Press the [HOME] key to exit the MENU mode.**

When a USB keyboard is connected to the FR-2, you can carry out the following operation.

↑/↓ keys	Acts the same as the [MENU] dial on the FR-2 panel.
<- key	Returns to the previous screen layer.
Enter key	Acts the same as the [ENTER] key on the FR-2 panel.

Adjusting the real time clock (Adjust Real Time)

This menu item sets the internal realtime clock. When the FR-2 is shipped, the realtime clock is adjusted to the local standard time. You can adjust the clock to your standard time by the following procedure.

The following description is assumed that the FR-2 is now in the MENU mode by pressing the [ENTER] key while the recorder is stopped.

- 1) Use the [MENU] dial to select "Setup" and press the [ENTER] key.

The display now shows the first page of the Setup menu.

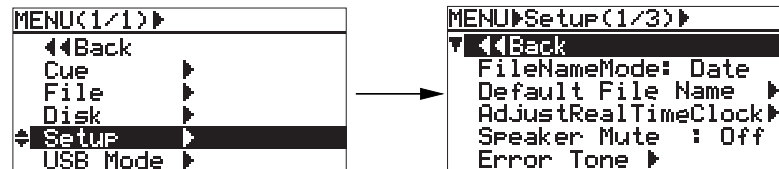

- 2) Use the [MENU] dial to select "AdjustRealTime" and press the [ENTER] key.

The current date and time according to the realtime clock is shown on the display in realtime.

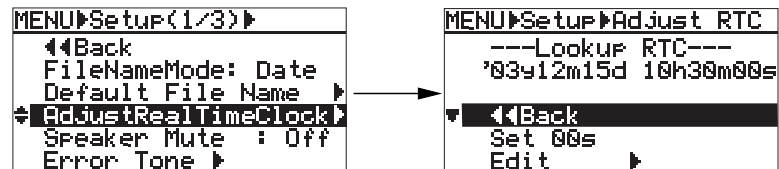

While the realtime clock is running, you can reset the second field to "00" by pressing the [ENTER] key while "Set 00s" is selected. When the second field shows a value between 00 and 29, only the second field is reset to "00". When the second field shows a value between 30 and 59, the minute field value is counted up and the second field is reset to "00".

- 3) Use the [MENU] dial to select "Edit" at the bottom and press the [ENTER] key.

The current time data is hold and you can edit the data (the year field starts flashing).

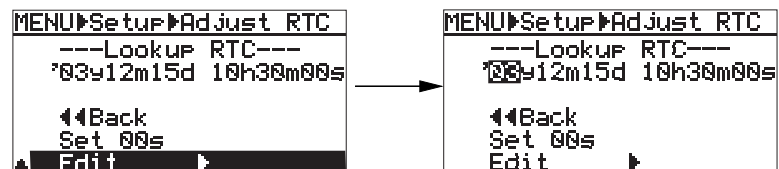

- 4) Use the [MENU] dial to enter the desired time data.

By pressing the [ENTER] key after entering a value to the year field, the cursor automatically moves to the month field.

If you do not change the year field, simply press the [ENTER] key.

Enter a desired value to each fields in the same manner.

- 5) **After entering a desired time value, press the [ENTER] key.**
 The entered time data is fixed and the display returns to the previous screen. You can set the realtime clock precisely by pressing the [ENTER] key in sync with the time signal after entering a value to the second field.

- 6) **Press the [HOME] key to exit the MENU mode**

When a USB keyboard is connected to the FR-2, you can carry out the following operation.

↑ / ↓ keys	Acts the same as the [MENU] dial on the FR-2 panel.
← key	Returns to the previous screen layer.
Numeric keys	You can directly set the date/time. The entered number fills up from the right digit towards the left.
Enter key	Acts the same as the [ENTER] key on the FR-2 panel.

<Note>: If you are going to fix data after entering illegal data using the numeric keys on your USB keyboard, the display shows "Illegal Value!" and the entered value is canceled. Then the display returns to show the screen for editing time data.

Speaker mute function on/off (Speaker Mute)

This menu item selects whether the internal monitor speaker is muted or not except during playback. The following description is assumed that the FR-2 is now in the MENU mode by pressing the [ENTER] key while the recorder is stopped.

Phones	Speaker mute setting	During input monitor	During recording	During playback
Unplugged	Off	Input source	Input source	Playback sound
	On	Mute	Mute	Playback sound
Plugged	On, Off	Mute	Mute	Mute

- 1) **Use the [MENU] dial to select "Setup" and press the [ENTER] key.**

The display now shows the first page of the Setup menu.

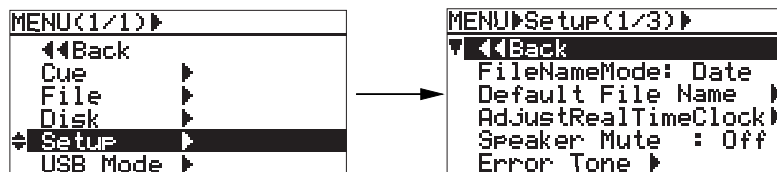

- 2) **Use the [MENU] dial to select "Speaker Mute" and press the [ENTER] key.**

The current setting ("On" or "Off") flashes (by default, "Off" flashes).

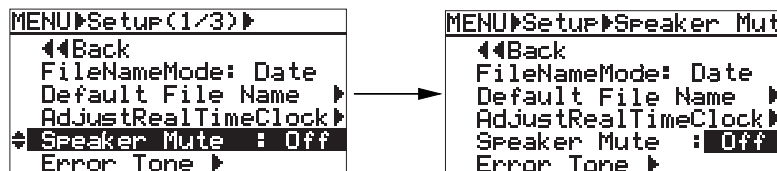

- 3) **Use the [MENU] dial to select "On" (or "Off") and press the [ENTER] key.**
 The selection is fixed and the display returns to the previous screen.
- 4) **Press the [HOME] key to exit the MENU mode.**

When a USB keyboard is connected to the FR-2, you can carry out the following operation.

↑/↓ keys	Acts the same as the [MENU] dial on the FR-2 panel.
← key	Returns to the previous screen layer.
Enter key	Acts the same as the [ENTER] key on the FR-2 panel.

Setting error tone output condition (Error Tone)

This menu item selects the condition in which the error tone is output. The error tone can be output to warn you when;

- * the input amplifier clips due to over level,
- * the battery voltage lowers the certain level, or
- * the remaining time of the memory card gets shorter than the specified time.

The following description is assumed that the FR-2 is now in the MENU mode by pressing the [ENTER] key while the recorder is stopped.

- 1) Use the [MENU] dial to select "Setup" and press the [ENTER] key.

The display now shows the first page of the Setup menu.

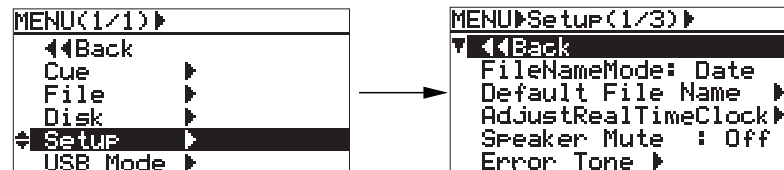

- 2) Use the [MENU] dial to select "Error Tone" and press the [ENTER] key.

The error tone setting screen is shown.

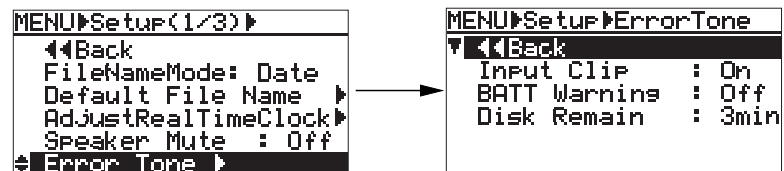

- 3) Use the [MENU] dial to select the item to be set and press the [ENTER] key.

The current option of the selected item flashes and now you can select the desired option. Depending on the selected item, the screen looks slightly different, as shown below.

When selecting "Input Clip":

You can select between "On" and "Off" (by default, "On" is selected). By setting it to "ON", the error tone is output when the input amplifier clips.

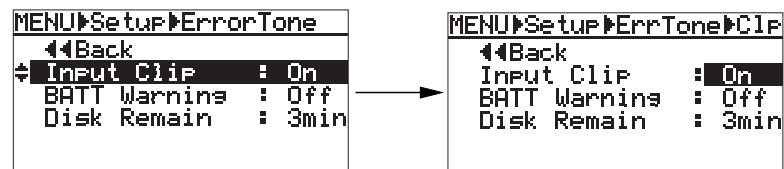

When selecting "BATT Warning":

You can select between "On" and "Off" (by default, "Off" is selected). By setting it to "ON", the error tone is output when the battery voltage lowers the certain level.

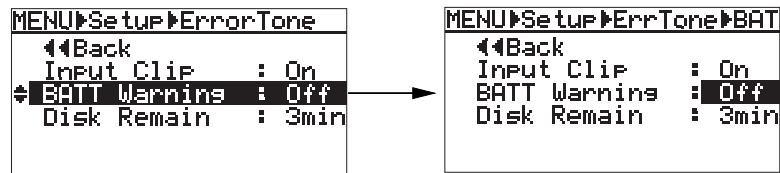

When selecting "Disk Remain":

You can select between "1min" and "9min" in 1 minute steps, as well as "off" (by default, "3min" is selected). The error tone is output when the remaining time of the memory card gets shorter than the selected time.

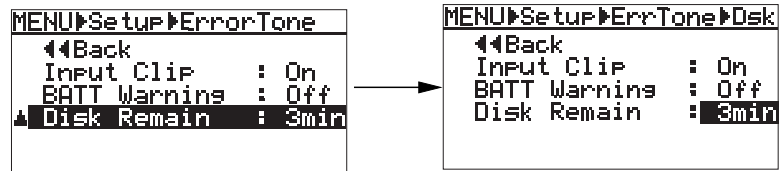

- 4) Use the [MENU] dial to select the desired option and press the [ENTER] key. The selection is fixed and the display returns to the previous screen.
- 5) Press the [HOME] key to exit the MENU mode.

When a USB keyboard is connected to the FR-2, you can carry out the following operation.

↑/↓ keys	Acts the same as the [MENU] dial on the FR-2 panel.
< key	Returns to the previous screen layer.
Enter key	Acts the same as the [ENTER] key on the FR-2 panel.

Setting the peak hold time of the level meters (Peak Hold Time)

This menu item sets the peak hold time of the level meters in one second steps (the default setting is 10 seconds). The following description is assumed that the FR-2 is now in the MENU mode by pressing the [ENTER] key while the recorder is stopped.

- 1) Use the [MENU] dial to select "Setup" and press the [ENTER] key. The display now shows the first page of the Setup menu.

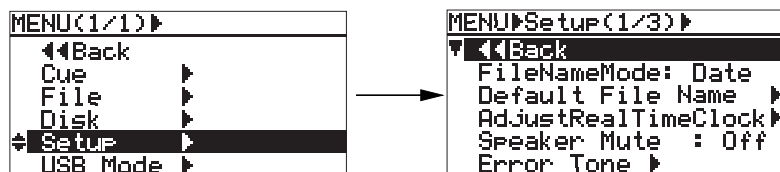

- 2) Use the [MENU] dial to select "Peak Hold Time" on the second page and press the [ENTER] key. The currently selected peak hold time starts flashing (by default, "3s" flashes).

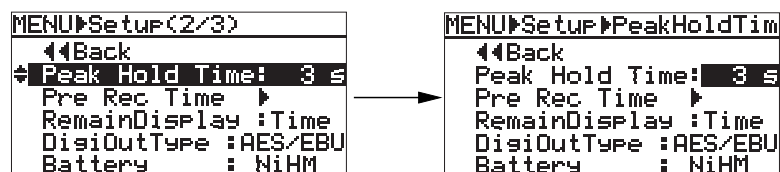

3) Use the [MENU] dial to select the desired time and press the [ENTER] key.

You can set the peak hold time between 0 second and 9 seconds in one second steps, as well as infinity ("INF s").

When "INF s" is selected, each level meter holds the peak until the [HOME/HOLD RESET] key on the front panel is pressed.

By pressing the [ENTER] key after selecting the time, the selected peak hold time is fixed and the display returns to show the previous screen.

4) Press the [HOME] key to exit the MENU mode.

When a USB keyboard is connected to the FR-2, you can carry out the following operation.

↑/↓ keys	Acts the same as the [MENU] dial on the FR-2 panel.
← key	Returns to the previous screen layer.
Enter key	Acts the same as the [ENTER] key on the FR-2 panel.

Setting the time length stored in the buffer for Pre rec mode (Pre Rec Time)

When the pre rec mode is active (i.e. when the [PRE REC] switch on the top panel is set to "ON"), the audio input signal is stored to the buffer. This menu item sets the length of audio stored in the buffer in one second steps .

The following description is assumed that the FR-2 is now in the MENU mode by pressing the [ENTER] key while the recorder is stopped.

1) Use the [MENU] dial to select "Setup" and press the [ENTER] key.

The display now shows the first page of the Setup menu.

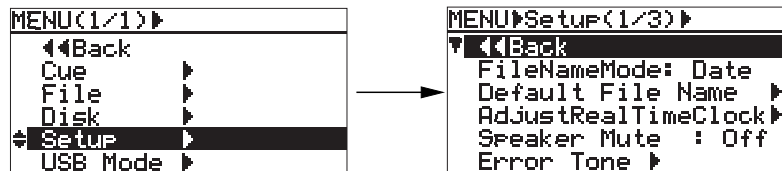

2) Use the [MENU] dial to select "Pre Rec Time" on the second page and press the [ENTER] key.

The display changes to show the screen for selecting the Pre Rec Time.

According to the current [FS (kHz)] switch setting, the current time length value flashes. (On the screen example below, the value for "44.1 kHz/48 kHz" flashes, because the [FS (kHz)] switch is set to "44.1" or "48".)

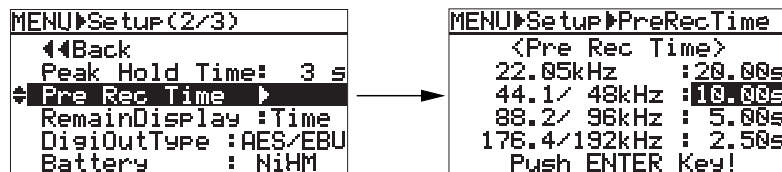

3) Use the [MENU] dial to select the desired time and press the [ENTER] key.

The adjustable range of the time length depends on FS. When changing any time value, values for other FS also change together.

The table below shows the adjustable range of the time length by FS.

22.05kHz	2.00s ~ 20.00s (in 2.00s steps)
44.1kHz/48kHz	1.00s ~ 10.00s (in 1.00s steps)
88.2kHz/96kHz	0.50s ~ 5.00s (in 0.50s steps)
176.4kHz/192kHz	0.25s ~ 2.50s (in 0.25s steps)

By pressing the [ENTER] key after selecting the time, the setting is fixed and the display returns to show the previous screen.

4) Press the [HOME] key to exit the MENU mode.

When a USB keyboard is connected to the FR-2, you can carry out the following operation.

↑/↓ keys	Acts the same as the [MENU] dial on the FR-2 panel.
← key	Returns to the previous screen layer.
Enter key	Acts the same as the [ENTER] key on the FR-2 panel.

Selecting the remain display mode (Remain Display)

This menu item selects whether to show the time or space (MBytes) remaining on the card for recording. The following description is assumed that the FR-2 is now in the MENU mode by pressing the [ENTER] key while the recorder is stopped.

1) Use the [MENU] dial to select "Setup" and press the [ENTER] key.

The display now shows the first page of the Setup menu.

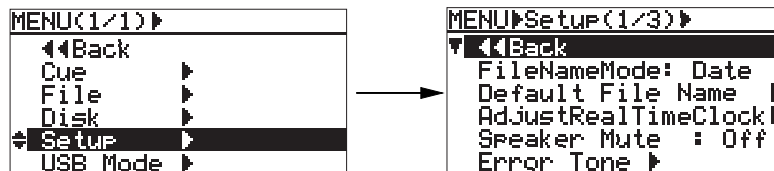

2) Use the [MENU] dial to select "RemainDisplay" on the second page and press the [ENTER] key.

The current setting starts flashing (by default, "Time" flashes).

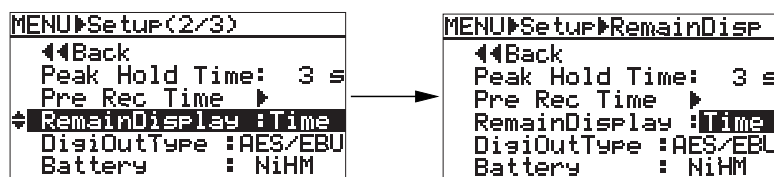

3) Use the [MENU] dial to select the desired option and press the [ENTER] key.

You can select between "Time" (default) and "MByte".

MByte	The remaining space of the memory card is displayed in MBytes.
Time	The remaining time of the memory card is displayed.

By pressing the [ENTER] key after selecting the desired option, the setting is fixed and the display returns to show the previous screen.

4) Press the [HOME] key to exit the MENU mode.

<Note>: See "Checking the remain for recording" on page 52 for details about remain display.

When a USB keyboard is connected to the FR-2, you can carry out the following operation.

↑/↓ keys	Acts the same as the [MENU] dial on the FR-2 panel.
<- key	Returns to the previous screen layer.
Enter key	Acts the same as the [ENTER] key on the FR-2 panel.

Setting the digital output signal format (Digi Out Type)

This menu item selects the format of the digital signal fed from the [DIGITAL OUT] connector. You can choose between "AES/EBU" (default) and "S/P DIF". The following description is assumed that the FR-2 is now in the MENU mode by pressing the [ENTER] key while the recorder is stopped.

- 1) Use the [MENU] dial to select "Setup" and press the [ENTER] key.

The display now shows the first page of the Setup menu.

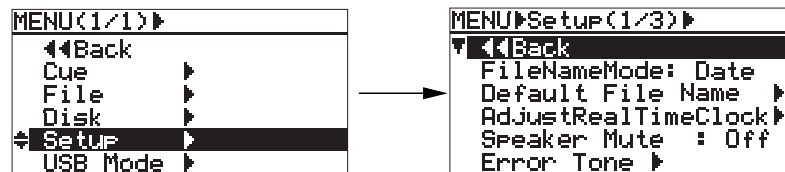

- 2) Use the [MENU] dial to select "DigiOutType" on the second page and press the [ENTER] key.

The current setting (by default, "AES/EBU") starts flashing.

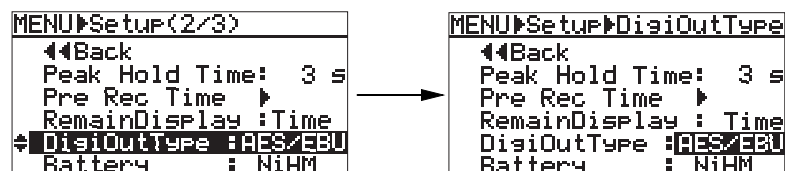

- 3) Use the [MENU] dial to select the desired signal format and press the [ENTER] key.

You can select between "AES/EBU" (default) and "S/P DIF".

AES/EBU	A signal in the IEC60958 (AES/EBU) format is output.
S/P DIF	A signal in the IEC60958 (S/P DIF) format is output.

By pressing the [ENTER] key after selecting the desired format, the setting is fixed and the display returns to show the previous screen.

- 4) Press the [HOME] key to exit the MENU mode.

When a USB keyboard is connected to the FR-2, you can carry out the following operation.

↑/↓ keys	Acts the same as the [MENU] dial on the FR-2 panel.
<- key	Returns to the previous screen layer.
Enter key	Acts the same as the [ENTER] key on the FR-2 panel.

Selecting the battery type (Battery)

This menu item selects the battery type when you use batteries (alkaline, Ni-Cd, or Ni-HM) for operating the unit.

The following description is assumed that the FR-2 is now in the MENU mode by pressing the [ENTER] key while the recorder is stopped.

<Caution>: Before operating the unit on batteries, make sure that the battery type is correctly set by this item. If the batteries do not match the setting, the error tone may not be correctly generated due to the difference of the power voltage, etc.

- 1) Use the [MENU] dial to select "Setup" and press the [ENTER] key.

The display now shows the first page of the Setup menu.

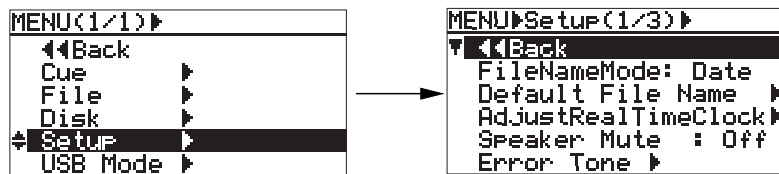

- 2) Use the [MENU] dial to select "Battery" on the second page and press the [ENTER] key.

The current setting (by default, "NiHM") starts flashing.

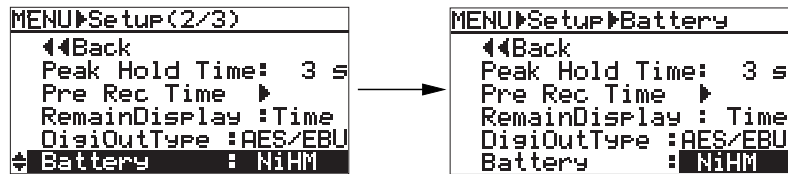

- 3) Use the [MENU] dial to select the desired battery type and press the [ENTER] key.

You can select the type from among "NiHM" (default), "NiCd" and "Alkali(ne)".

By pressing the [ENTER] key after selecting the desired option, the setting is fixed and the display returns to show the previous screen.

- 4) Press the [HOME] key to exit the MENU mode.

When a USB keyboard is connected to the FR-2, you can carry out the following operation.

↑/↓ keys	Acts the same as the [MENU] dial on the FR-2 panel.
← key	Returns to the previous screen layer.
Enter key	Acts the same as the [ENTER] key on the FR-2 panel.

Selecting the USB keyboard type (Keyboard)

This menu item selects the USB keyboard type (between "US" and "JAPAN") to match the keyboard connected to the [USB (KEYBOARD ONLY)] port on the left side panel. The following description is assumed that the FR-2 is now in the MENU mode by pressing the [ENTER] key while the recorder is stopped.

<Note>: Fostex does not guarantee keyboard operations if you use a keyboard with built-in USB hub, USB mouse or PS2 mouse.
Also note that, some keyboards do not work correctly until pressing any key after connection is made.

- 1) Use the [MENU] dial to select "Setup" and press the [ENTER] key.

The display now shows the first page of the Setup menu.

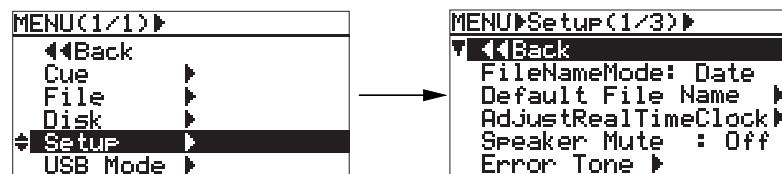

- 2) Use the [MENU] dial to select "Keyboard" on the third page and press the [ENTER] key.

The current setting (by default, "US") starts flashing.

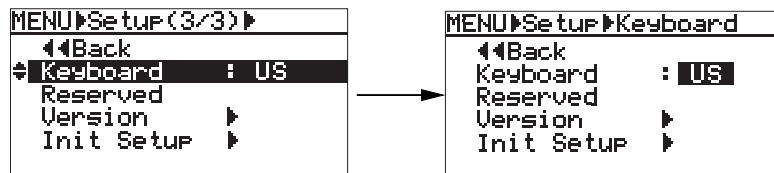

- 3) Use the [MENU] dial to select the desired keyboard type and press the [ENTER] key.
You can select between "US" and "JAPAN".

By pressing the [ENTER] key after selecting the desired type, the setting is fixed and the display returns to show the previous screen.

- 4) Press the [HOME] key to exit the MENU mode.

When a USB keyboard is connected to the FR-2, you can carry out the following operation.

↑/↓ keys	Acts the same as the [MENU] dial on the FR-2 panel.
← key	Returns to the previous screen layer.
Enter key	Acts the same as the [ENTER] key on the FR-2 panel.

Viewing the ROM version (Version)

This menu item is used for viewing the ROM version of the unit. The following description is assumed that the FR-2 is now in the MENU mode by pressing the [ENTER] key while the recorder is stopped.

- 1) Use the [MENU] dial to select "Setup" and press the [ENTER] key.

The display now shows the first page of the Setup menu.

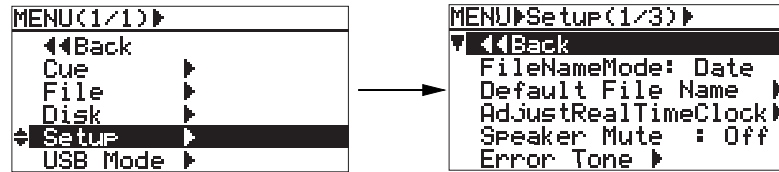

- 2) Use the [MENU] dial to select "Version" on the third page and press the [ENTER] key.

The current version of the ROM installed to the unit is displayed.

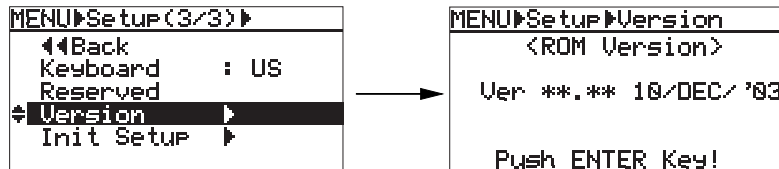

- 3) To dismiss the ROM version screen, press the [ENTER] key.
- 4) Press the [HOME] key to exit the MENU mode.

When a USB keyboard is connected to the FR-2, you can carry out the following operation.

↑/↓ keys	Acts the same as the [MENU] dial on the FR-2 panel.
← key	Returns to the previous screen layer.
Enter key	Acts the same as the [ENTER] key on the FR-2 panel.

Initializing settings of the Setup menu (Init Setup)

This menu item is used for initializing all settings of the Setup menu to the factory preset condition. The following description is assumed that the FR-2 is now in the MENU mode by pressing the [ENTER] key while the recorder is stopped. By executing this menu item, the Setup menu items are initialized to the default settings as shown below.

File Name Mode	Date	
Default Scene Name	Scene Name	Scene01 - Scene99
	Take Number	001
Speaker Mute	Off	
Error Tone	Input Clip	On
	Battery Warning	On
	Memory Warning	3min
Peak Hold	3s	
Pre Rec Time	20s (22.05), 10s (44.1/48), 5s (88.2/96), 2.5s (176.4/192)	
Remain Display	Time	
Digi Out Type	AES/EBU	
Battery	NiHM	
Keyboard Type	US	

* In addition to the items above, the contrast value is also initialized.

- 1) Use the [MENU] dial to select "Setup" and press the [ENTER] key.

The display now shows the first page of the Setup menu.

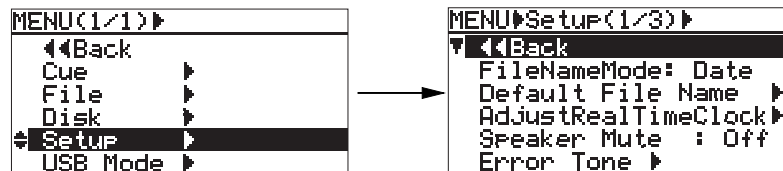

- 2) Use the [MENU] dial to select "Init Setup" on the third page and press the [ENTER] key.

The display changes to show the "Initialize Setup" screen as shown below right, in which "Are you sure?" flashes.

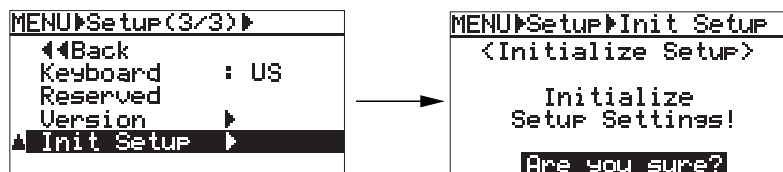

- 3) To executing initializing, press the [ENTER] key.

The settings are initialized. When completed, "Completed!" is shown.

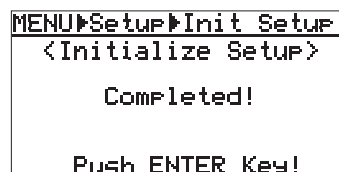

- 4) Press the [ENTER] key, followed by the [HOME] key to exit the MENU mode.

When a USB keyboard is connected to the FR-2, you can carry out the following operation.

↑ / ↓ keys	Acts the same as the [MENU] dial on the FR-2 panel.
<- key	Returns to the previous screen layer.
Enter key	Acts the same as the [ENTER] key on the FR-2 panel.

Chapter 7: Exporting audio files to a PC

This chapter describes how to export audio files created by the FR-2 to your PC.

Connecting the FR-2 to a PC

By connecting the FR-2 to your PC via the USB ports, you can transfer audio (BWF) files created by the FR-2 between your PC and a memory card. FR-2 audio data can be copied to a hard disk on your PC, or exported to a computer application such as Digidesign Pro Tools.

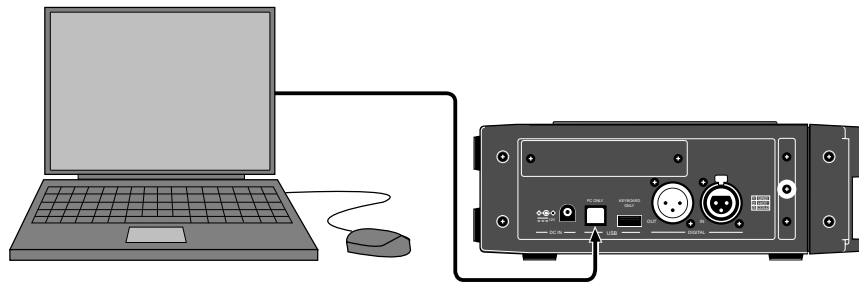

<Note on using the FR-2 with a PC>
When you use the FR-2 with your PC, operate the FR-2 on the AC adaptor in order to supply the stable power to the FR-2.

<Notes>

- * For transferring audio files, you only can use a PC which runs on Windows ME, 2000 or XP OS and supports USB connection. Note that you cannot use a Macintosh computer or any computer which does not run on the OS above. Make sure that your PC can be used with the FR-2 before making connection.
- * If you use a Windows PC which does not have a USB connector, you can make backup of data recorded on a memory card by using a CFC/PCMCIA card leader, etc.

* All company names and model names mentioned in this manual are trademarks or registered trademarks of their respective holders.

Connecting the FR-2 to a PC

The following description shows how to connect the FR-2 to a Windows ME machine.

- 1) Turn on the power of both the PC and FR-2.
- 2) Press the [ENTER] key of the FR-2 to enter the MENU mode.
The display shows the first layer of the MENU mode screen.

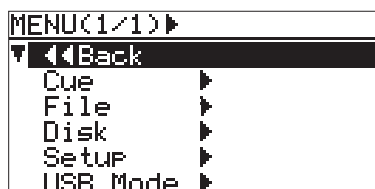

- 3) Use the [MENU] dial to select "USB Mode" at the bottom and press the [ENTER] key.
The display now shows the USB Mode screen.
You can transfer audio data while this screen is shown.

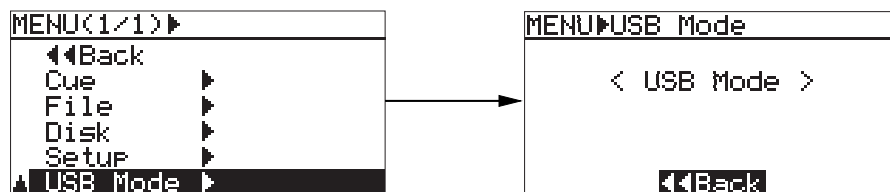

<Note>: While the FR-2 is in the USB mode, all controls (keys, switches, etc.) on the FR-2 panel except the [ENTER] key are disabled.

- 4) Use a USB cable to connect the FR-2 to the PC.
- 5) By opening "My computer" on the PC, a drive named "Removable disk" is added to the PC.
The first time you connect the FR-2 to the PC, the disk driver is installed.
- 6) Open the removable disk drive newly added and select a desired audio file in the appropriate folder, and then copy it to the PC.
When opening the removable disk drive newly added, all audio files stored to the memory card in the current drive is shown.

While transferring file data from the FR-2 to the PC, the [ACCESS] indicator on the FR-2 panel lights (or flashes). When completing data transfer, the [ACCESS] indicator turns off.

<Note>: When file data is copied from the folder, the original file on the memory card remains. When file data is "moved" to a folder, the original file disappears from the card.

- 7) After transferring the file data, remove the USB cable from the PC.

<Note>: To disconnect the FR-2 from the PC after exporting the file data, make sure that the [ACCESS] indicator is unlit, and follow the instructions of the Windows "Safely Remove Hardware" application.

- 8) Press the [HOME] key to exit the MENU mode.

Exporting audio data to a computer application (example)

The following procedure example shows how to export FR-2 audio data to Digidesign Pro Tools for Windows.

For details about instructions for Pro Tools, see the instruction manual attached to Pro Tools. (Note that the display examples shown here may be different from those you see on your PC.)

- 1) Start up Pro Tools on your PC.
- 2) Click on "Audio" in the Pro Tools window to bring up the popup menu of the audio region list (see arrow 1 below).
- 3) From the popup menu, select the "Import Audio" item (see arrow 2 below).

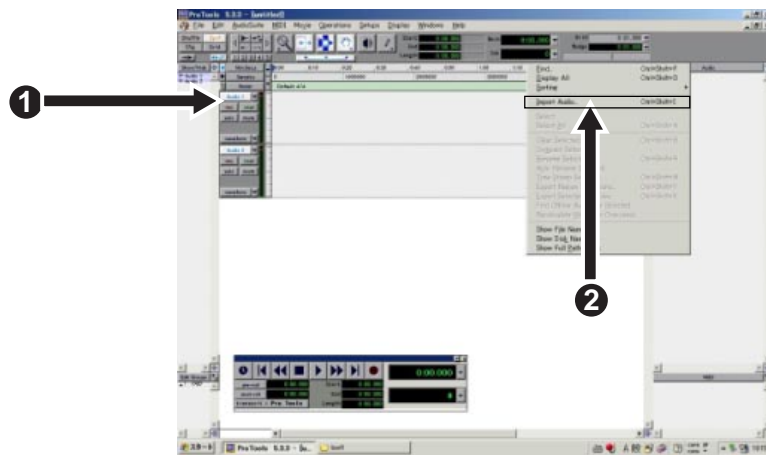

- 4) Select "CFC000" or "PCM000" on the desktop (see arrow 3 below).
The disk volume label in the example below shows a tentative volume label which is given by default.
If the tentative (default) volume label of the memory card has been edited using the "Volume Label" menu item on the "Disk" menu in the MENU mode, the edited label is shown.

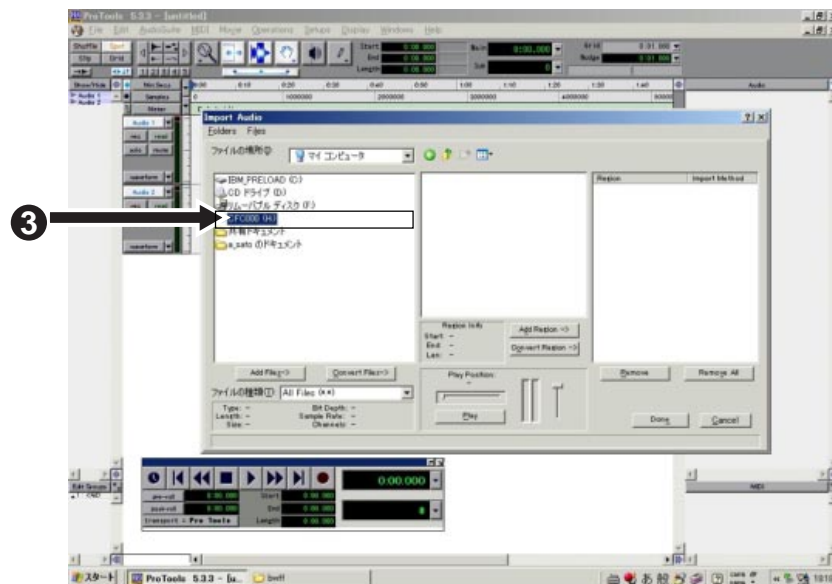

- 5) **Select a desired audio file in the "bwff" directory on the card (see arrow 4 below).**
The selected audio file is shown in "Region in current file".
- 6) **Click on "Convert ->", followed by "Done" (see arrow 5 below).**
The display shows the window for selecting a folder for storing the file.

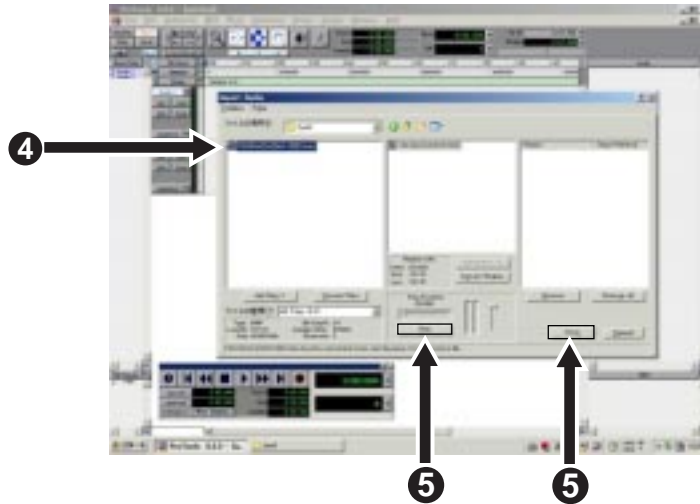

- 7) **Select a desired destination folder for storing the file and click on "Select" (see arrow 6 below).**
The PC starts storing the selected file to the folder.

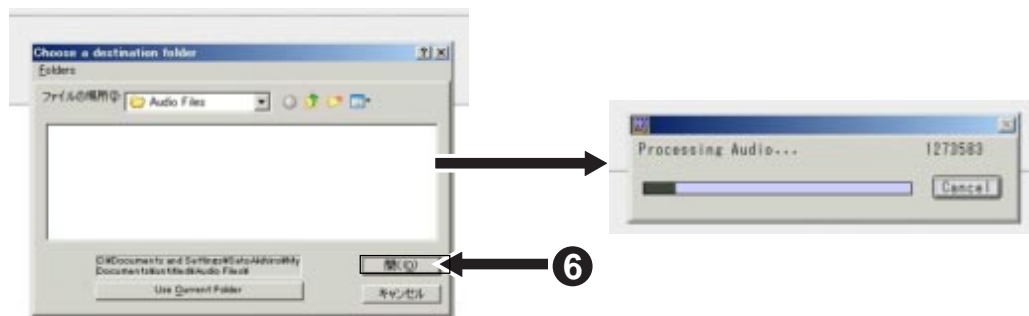

The stored file is displayed in the audio region list (see arrow 7 below).

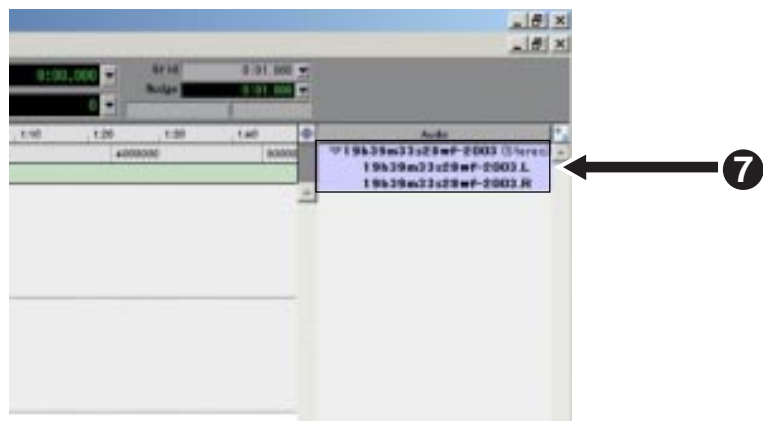

- 8) Enable "Spot" and drag & drop the audio region list to the track area (see arrow 8). The "Spot Dialog" window appears.

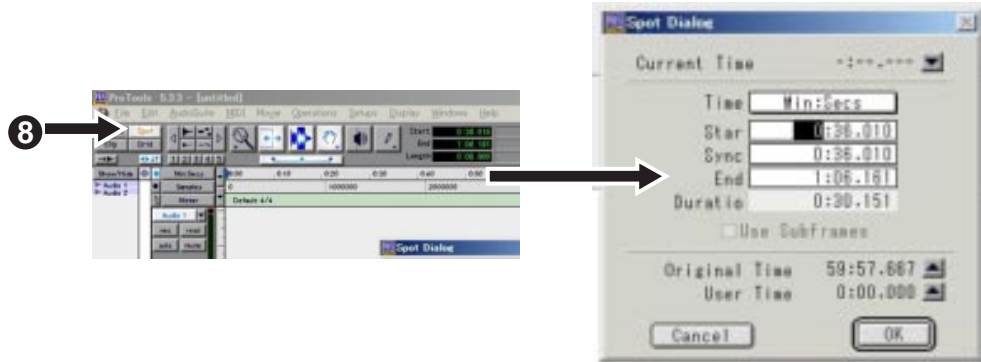

- 9) Click on "▲" in the "Spot Dialog" window, followed by "OK" (see arrow 9 below). Clicking on "▲" sets the "Original Time Stamp" time to the "Start" time. Then clicking on "OK" imports audio data from the specified position.

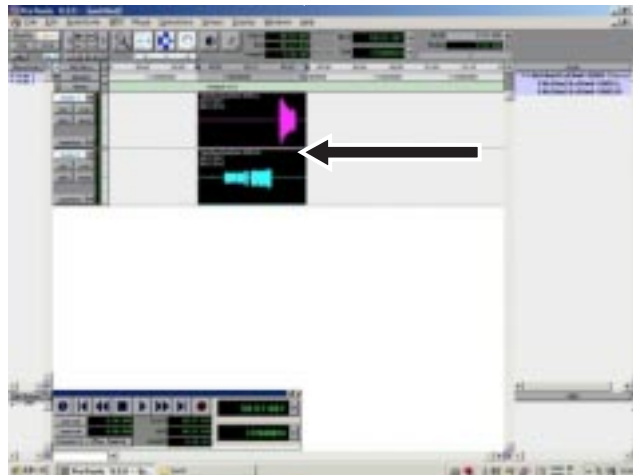
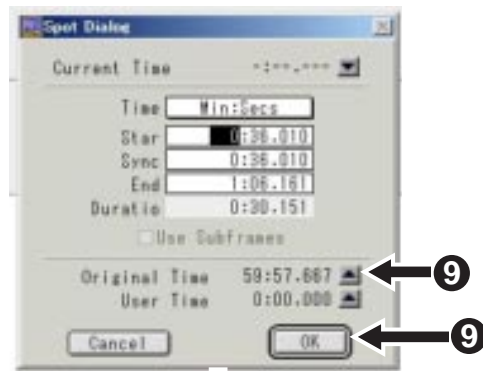

Chapter 8: Main specifications

Inputs/Outputs

*0 dBu=0.775 Vrms, 0 dBV=1 Vrms.
Reference level: -20 dB

ANALOG IN [L (MONO)/R]

Connectors: XLR-3-31 type (balanced, pin 2 hot)

<LINE>
Input impedance: More than 6k Ω
Nominal input level: 4dBu
Maximum input level: +24 dBu (TRIM: +4dBu, at the prefader stage)

<MIC>
Input impedance: More than 6k Ω
Nominal input level: -60 dBu
Maximum input level: -40 dBu (TRIM: +4dBu, at the prefader stage)
Phantom power: 48 V

ANALOG OUT [L (MONO)/R]

Connectors: RCA type (unbalanced)
Applicable load impedance: More than 10k Ω
Nominal output level: +4 dBu

PHONES

Connector: 1/4" stereo phone jack
Applicable load impedance: More than 32 Ω
Maximum output power: 50 mW + 50 mW (32 Ω load)

DIGITAL IN/OUT (176.4 kHz and 192 kHz FS are not supported.)

Connector:
<Input>: XLR-3-31 type (balanced, pin 2 hot)
<Output>: XLR-3-32 type (balanced, pin 2 hot)

Format:
<Input>: IEC 60958 (S/P DIF) or IEC 60958 (AES/EBU), auto selection
<Output>: IEC 60958 (S/P DIF) or IEC 60958 (AES/EBU),
The format of the digital output signal can be selected in the MENU mode.

USB (for PC connection)

Connector: USB 1.1 (Series "B" Receptacle)
Pin assignment: 1: VBUS, 2: D-, 3: D+, 4: GND

USB (for USB keyboard connection)

Connector: Series "A" Receptacle
Pin assignment: 1: VBUS, 2: D-, 3: D+, 4: GND

MONITOR SPEAKER

Maximum output level: 1 W

Recording/playback

Recording medium:	CompactFlash card™/Flash ATA card
Recording Format:	BWF (Broadcast Wave Format)
Quantization and Sampling Frequency:	16-bit at 22.05kHz/44.1kHz/48kHz 24-bit at 44.1kHz/48kHz/88.2kHz/96kHz/176.4kHz/192kHz
Recording tracks:	stereo/mono
Record/Playback frequency response:	20Hz to 10kHz, +/-1 dB (at 22.05kHz FS) 20Hz to 20kHz +/-1 dB (at 44.1kHz / 48kHz FS) 20Hz to 40kHz, +/-2 dB (at 88.2kHz / 96kHz FS) 20Hz to 80kHz +/-3 dB (at 176.4kHz / 192kHz FS)
Signal to Noise Ratio (between ADC and DAC, 24-bit, ref. -20 dB, 48 kHz FS)	Line (input gain: +4 dBu): 100dB (typical) Mic (input gain: -60 dBu): 87dB (typical)
Dynamic Range (between ADC and DAC, 24-bit, ref. -20 dB, 48 kHz FS)	100dB (typical)
T.H.D. (between ADC and DAC, 24-bit, ref. -20 dB, 48 kHz FS)	Line (input gain: +4 dBu): Less than 0.005% (at 1 kHz, -1 dB typical) Mic (input gain: -60 dBu): Less than 0.008% (at 1 kHz, -1 dB typical)
Locate memory:	99 cue points per file can be stored.

General

Dimensions:	77 (H) x 250 (W) x 220 (D) mm
Weight:	1.5kg (excluding batteries)
Power supply:	DC 12V eight AA-type alkaline/Ni-Cd/Ni-HM batteries or AC adaptor AD12-1300 (option, DC 12V)
	
Power consumption:	approximately 5.7~10W
Battery life (for continuous use):	approximately 2 hours 30 minutes (using "2300 mAh" Ni-HM batteries)

* Specifications and appearance are subject to change without notice for product improvement.

Physical dimensions

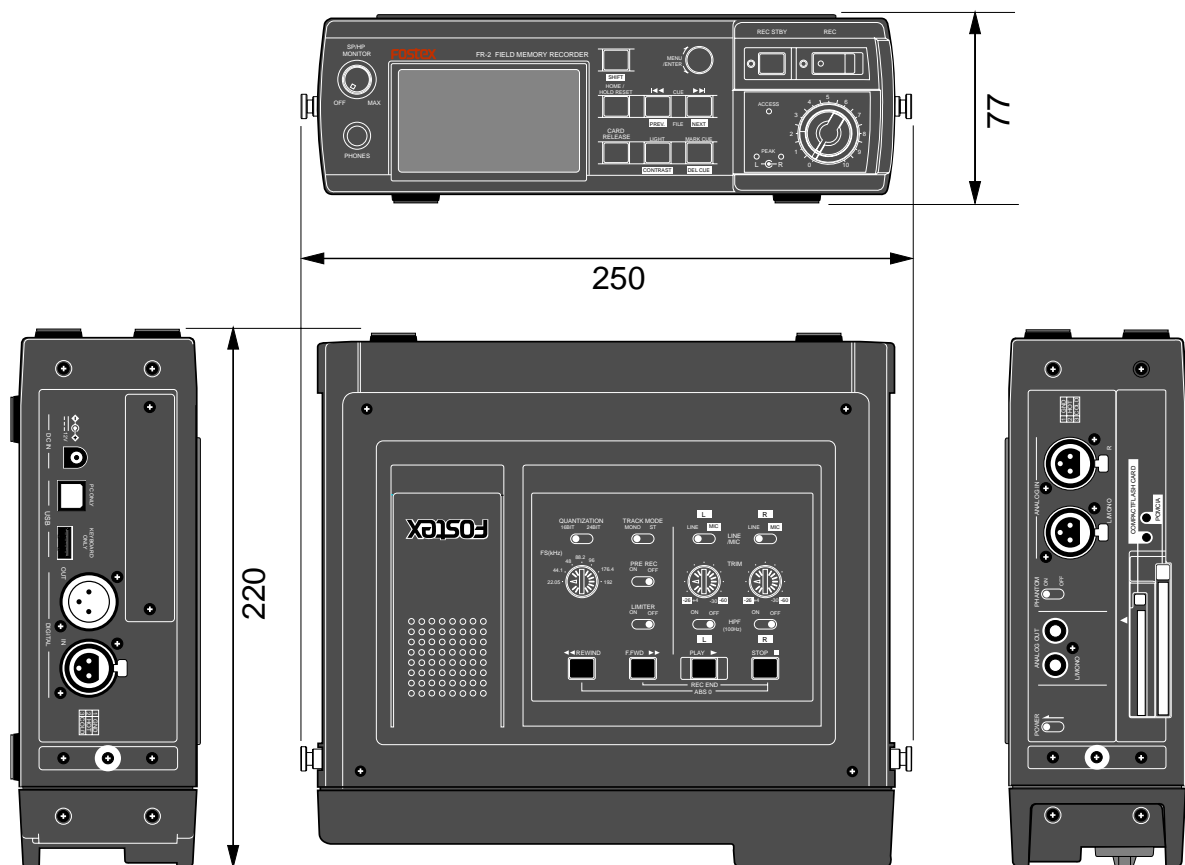

Declaration of EC Directive

This equipment is compatible with the EMC Directive (89/336/EEC) - Directive on approximation of member nation's ordinance concerning the electromagnetic compatibility and with the Low Voltage Directive (73/23/EEC) - Directive on approximation of member nation's ordinance concerning electric equipment designed to be used within the specified voltage range.

The Affect of Immunity on This Equipment

The affect of the European Specification EN61000-6-1 (coexistence of electromagnetic waves - common immunity specification) on this equipment are as shown below.

In the electrical fast transient/burst requirements, surge, conducted disturbances by radio-frequency fields, power frequency magnetic field, radiate electromagnetic field requirements and static electricity discharging environment, this could be affected by generation of noise in some cases.

FOSTEX DISTRIBUTORS LIST IN EUROPE

* Including non-EU countries (as of October, 2003)

<AUSTRIA>

NAME: ATEC Audio-u. Videogeraete VertriebsgesmbH.
ADD: Im Winkel 5, A-2325 Velm, Austria
TEL: (+43) 2234-74004, FAX: (+43) 2234-74074

<BELGIUM>

NAME: General Audio
ADD: Albert Temmerstraat 21, 1731 Zellik, Belgium
TEL: (+32) 2-4630650, FAX: (+32) 2-4661500

<DENMARK>

NAME: SC Sound ApS
ADD: Malervej 2, DK-2630 Taastrup, Denmark
TEL: (+45) 4399-8877, FAX: (+45) 4399-8077

<FINLAND>

NAME: Norettron Oy Audio
ADD: P. O. Box 22, FIN-02631 Espoo, Finland
TEL: (+358) 9-5259330, FAX: (+358) 9-52593352

<FRANCE>

NAME: Sennheiser France
ADD: 128 bis, avenue Jean-Jaures, 94851 Ivry-sur-Seine Cedex, France
TEL: (+33) 1 4987 0300, FAX: (+33) 1 4987 0324

<GERMANY>

NAME: Mega Audio GmbH
ADD: Stromberger Str. 32, D-55411 Bingen, Germany
TEL: (+49) 6721-94330, FAX: (+49) 6721-32046

<GREECE>

NAME: Bon Studio S. A.
ADD: 6 Zaimi Street, Exarchia, 106.83 Athens, Greece
TEL: (+30) 210-3809-605, 606, 607, 608
FAX: (+30) 210-3845-755, 210-3827-868

<ICELAND>

NAME: I. D. elrf. electronic Ltd.
ADD: ARMULA 38 108 REYKJAVIK, ICELAND
TEL: (+354) 588 5010, FAX: (+354) 588 5011

<ITALY>

NAME: Proel S. p. A.
ADD: Zona Via Alla Ruenia, 37/43 64027 - Sant'Omero (Teramo), Italy
TEL: (+39) 0861-81241, FAX: (+39) 0861-887862

<THE NETHERLANDS>

NAME: IEMKE ROOS AUDIO B. V.
ADD: Kuiperbergweg 20, 1101 AG Amsterdam, The Netherlands
TEL: (+31) 20-697-2121, FAX: (+31) 20-697-4201

<NORWAY>

NAME: Fitzpatrick
ADD: P. B. 4316 Nydalen, 0402 Oslo, Norway
TEL: (+47) 23 400 380, FAX: (+47) 23 400 389

<PORTUGAL>

NAME: Caius - Tecnologias Audio e Musica, Lda.
ADD: Praca do Bom Sucesso, No 61 Bom Sucesso Trade Center, Escritorio 701/702, 4150 - 146 Porto, Portugal
TEL: (+351) 22-608-06-10, FAX: (+351) 22-608-06-29

<SPAIN>

NAME: Letusa S. A.
ADD: C/Laguna 10, 28923 Alcorcon, Madrid, Spain
TEL: (+34) 91-4862800, FAX: (+34) 91-6414597

<SWEDEN>

NAME: TTS Scandinavia AB
ADD: Kavallerivagen 24, 172 48 Sundbyberg, Sweden
TEL: (+46) 8-59798000, FAX: (+46) 8-59798001

<SWITZERLAND>

NAME: Audio Bauer Pro AG
ADD: Bernerstrasse-Nord 182, CH-8064 Zurich, Switzerland
TEL: (+41) 1-4323230, FAX: (+41) 1-4326558

<UK>

NAME: SCV London
ADD: 40 Chigwell Lane, Oakwood Hill Industrial Estate, Loughton, Essex IG10 3NY U. K.
TEL: (+44) 20-8418-0778, FAX: (+44) 20-8418-0624

Memo

Fostex[®]

FOSTEX CO.

3-2-35, Musashino, Akishima-shi, Tokyo, Japan 196-0021

FOSTEX AMERICA

15431, Blackburn Avenue, Norwalk, CA 90650, U. S. A.